

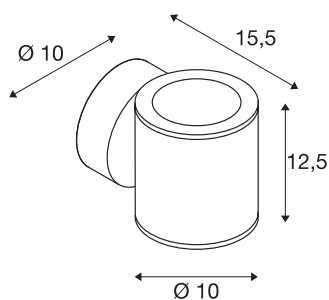

SITRA

outdoor wall light, double-headed, TCR-TSE, IP44, up/down, anthracite, max. 18W

The double-headed SITRA wall light is made from aluminium and structured glass, which covers the lamp. Thanks to the position of the two sockets which are fitted, the mounted luminaire produces two equal but opposite cones of light (UP/DOWN). It is suitable for use outdoors thanks to its IP44 protection class. The electrical connection of the luminaire, which comes in two colours, is made directly to the 230V mains supply. The SITRA series also contains single-headed wall lights and can therefore be used universally.



TECHNICAL DATA

Item no.:	230365
Socket	GX53
Lamp	TCR-TSE
Number of sockets	2
Lamps included	No
Number of different light outlets	1
Primary nominal voltage	220-240V ~50/60Hz mA/V
Width	10 cm
Height	12.5 cm
Depth	15.5 cm
Net weight	1.082 kg
Gross weight	1.215 kg
IP Code	IP 44
Safety class	I
Assembly	Surface
Assembly details	Wall
Wattage	9 W
Color	anthracite
BIG WHITE Page	644

Recommended lamp

1005269	TCR TSE GX53 , white / milky LED light, 6W 4000K CRI90 120°
1005271	TCR TSE GX53 , white / milky LED light, 6W 3000K CRI90 120°
1005272	TCR TSE GX53 , white / milky LED light, 6W 2700K CRI90 120°