

Decorative  
Fans

Luminarias Profesionales

Luminarias Profesionales

LED  
LIGHTS  
COZY



# LedsC4

2026

# Content

006	<b>Summary</b>
020	<b>Universes</b>
022	<b>Services</b>
024	<b>Sustainability</b>
026	<b>Decorative</b>
374	<b>Fans</b>
414	<b>Smart lighting devices</b>

# Index by Family

## Attic

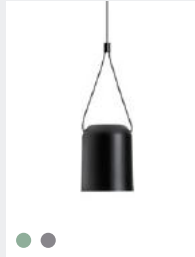

Suspensión  
Suspensão

129



Superficie de pared  
Superfície de parede

300

## Bloom

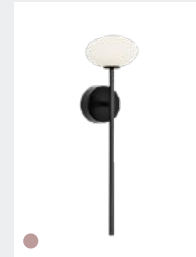

Superficie de pared  
Superfície de parede

288

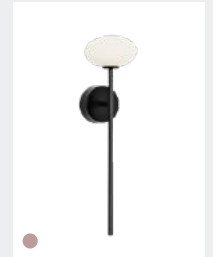

Baño  
Casa de banho

360

## Caprice



Suspensión  
Suspensão

168



Superficie de techo  
Superfície de teto

344

## Circular



Suspensión  
Suspensão

030



Superficie de pared  
Superfície de parede

030

## Clip



Lectura  
Leitura

202



Sobremesa  
De mesa

234



Pie  
Pé

268

## Gamma

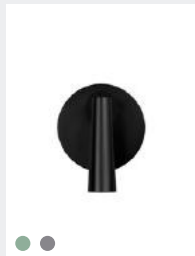

Lectura  
Leitura

192



Lectura  
Leitura

194



Sobremesa  
De mesa

228



Pie  
Pé

264

## Gong



Suspensión  
Suspensão

104



Superficie de techo  
Superfície de teto

332

● Quick Service

● Performance Universe

● Essential Universe

Consulta la explicación completa en P. 034  
Consulte a explicação completa na P. 034

## Hop



Suspensión  
Suspensão

046



Superficie de pared  
Superfície de parede

046

## H



Suspensión  
Suspensão

140



Sobremesa  
De mesa

216



Pie  
Pé

258



Superficie de pared  
Superfície de parede

306

## Ilargi



Suspensión  
Suspensão

092



Sobremesa  
De mesa

218

## Invisible

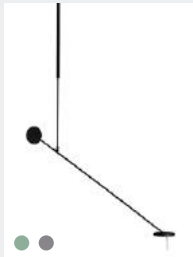

Suspensión  
Suspensão

151



Lectura  
Leitura

184



Sobremesa  
De mesa

226



Pie  
Pé

262

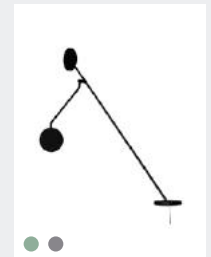

Superficie de pared  
Superfície de parede

292

## Levels



Suspensión  
Suspensão

086



Sobremesa  
De mesa

212



Pie  
Pé

250



Superficie de techo  
Superfície de teto

328

## Metrica



Lectura  
Leitura

204



Sobremesa  
De mesa

236



Pie  
Pé

270



Superficie de pared  
Superfície de parede

313

**Miso**



Superficie de pared  
Superficie de parede  
309



Superficie de techo  
Superficie de teto  
346

**Noway**



Suspensión  
Suspensão  
124

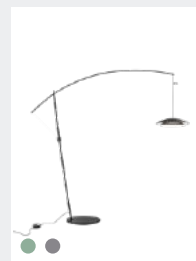

Pie  
Pé  
256

**Nude**



Sobremesa  
De mesa  
231

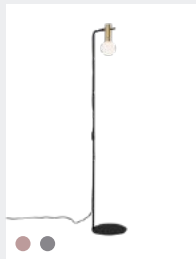

Pie  
Pé  
265

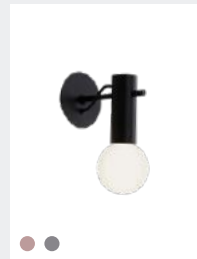

Superficie de pared  
Superficie de parede  
312

**Organic**



Sobremesa  
De mesa  
229



Pie  
Pé  
253



Superficie de pared  
Superficie de parede  
308

**Perlina**



Lectura  
Leitura  
182



Sobremesa  
De mesa  
220



Pie  
Pé  
254



Superficie de pared  
Superficie de parede  
276

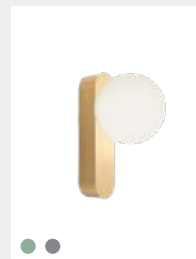

Baño  
Casa de banho  
358

**Pipe**



Suspensión  
Suspensão  
170



Lectura  
Leitura  
196



Superficie de techo  
Superficie de teto  
354

**Prolix**



Suspensión  
Suspensão  
154



Superficie de pared  
Superficie de parede  
294



Superficie de techo  
Superficie de teto  
350

## Simply



Lectura  
Leitura

197

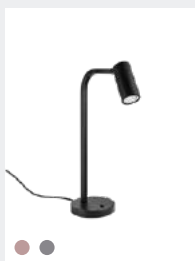

Sobremesa  
De mesa

230



Superficie de techo  
Superficie de teto

353

## Spark



Superficie de pared  
Superficie de parede

278



Superficie de techo  
Superficie de teto

340

## Stylus



Suspensión  
Suspensão

172



Lectura  
Leitura

198



Superficie de techo  
Superficie de teto

355

## Super Attic



Suspensión  
Suspensão

136



Superficie de pared  
Superficie de parede

304

## Tubs



Sobremesa  
De mesa

222



Pie  
Pé

260

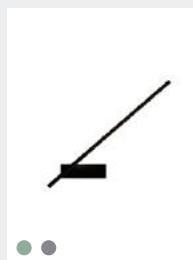

Superficie de pared  
Superficie de parede

289

## Tubs Modular



Suspensión  
Suspensão

058

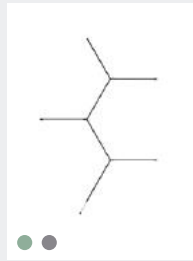

Superficie de pared  
Superfície de parede

058

## Veneto



Suspensión  
Suspensão

120



Superficie de pared  
Superfície de parede

298

## Vetro



Superficie de pared  
Superfície de parede

311



Superficie de techo  
Superfície de teto

349



Baño  
Casa de banho

370

# Index by Product

# Decorative

## Colecciones Modulares Coleções Modulares 028



Circular 030



Geometric 038

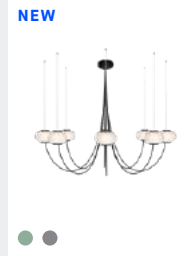

Hop 046



Scarlett 052



Tubs Modular 058

## Suspensión Suspensão 076



Voiles 082



Levels 086



Ilargi 092



Iris 095



Plat 098



Khoi 100



Glam 102



Gong 104

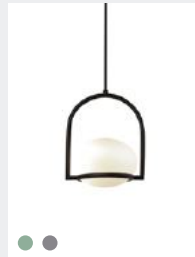

Coco 112

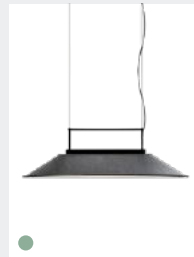

Shoemaker 116

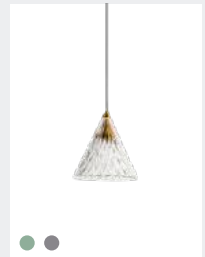

Veneto 120



Nimes 122



Noway 124



Keops 126

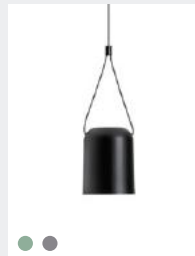

Attic 129



Super Attic 136

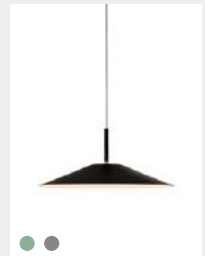

H 140



Napa 143



Candle 145

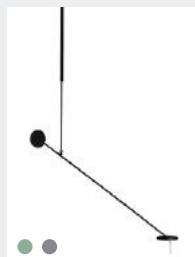

Invisible 151



Prolix 154



Dew 156

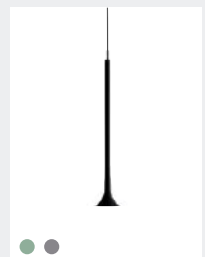

Alive 159



Punto 162



Mist 164



Circ 165



Caprice 168

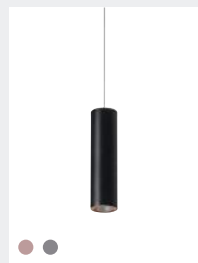

Pipe 170



Stylus 172



Bravo 174



Bol 177

**Lectura**  
**Leitura**  
**178**



Perlina 182



Invisible 184

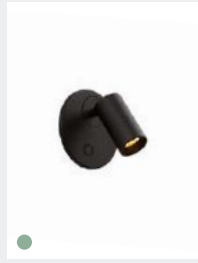

Chic 186



E-lamp 188



E-lamp Mini 190



Hall Slim 191

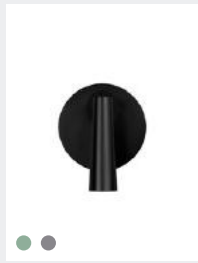

Gamma 192

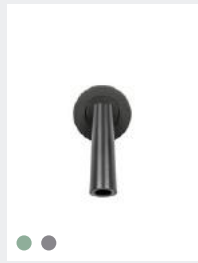

Gamma Mini 193



Gamma Extend 194



Radar 195



Pipe 196



Simply 197



Stylus 198



Bed 199

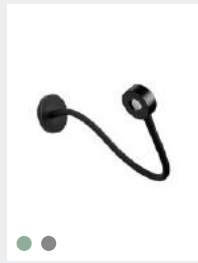

Link 200



Tip 201



Clip 202



Metrica 204

**Sobremesa**  
De mesa  
208



**Dara** 210



**Levels** 212



**H** 216



**Ilargi** 218



**Perlina** 220



**Tubs** 222

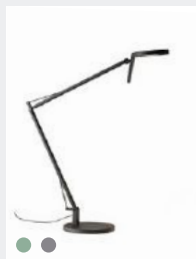

**Maca** 224



**Invisible** 226



**Gamma** 228



**Organic** 229



**Simply** 230



**Nude** 231



**Clip** 234



**Metrica** 236

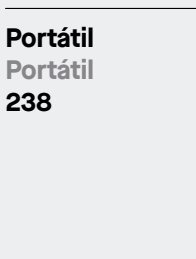

**Cocktail** 240



**Portobello** 244

**Portátil**  
**Portátil**  
238

**Pie**  
**Pé**  
248



**Levels** 250



**Organic** 253



**Perlina** 254

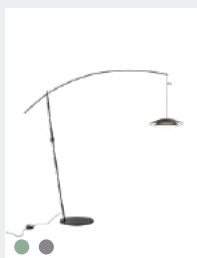

**Noway** 256



**H** 258



**Tubs** 260



**Invisible** 262



**Gamma** 264



**Nude** 265



**Clip** 268



**Metrica** 270

Superficie  
de pared  
Superficie  
de parede  
272



Perlina 276



Spark 278



Trip 281

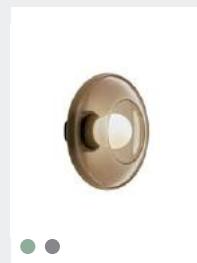

Trip Glass 286

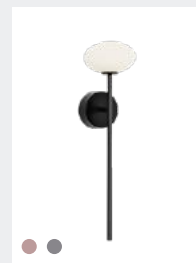

Bloom 288

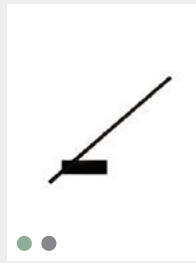

Tubs 289

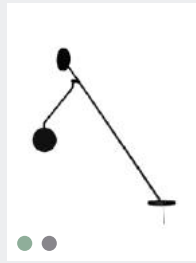

Invisible 292



Prolix 294



NEW  
Linea 296



Veneto 298



Big Bang 299



Attic 300



Super Attic 304

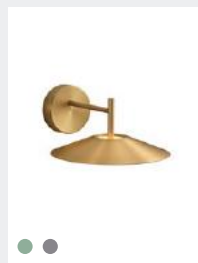

H 306



Organic 308



Miso 309



Drone 310



Vetro 311

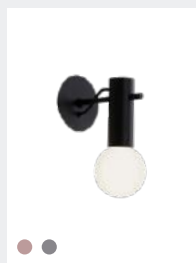

Nude 312



Metrica 313



Fino 314



Duna 316



Lia 317



Lia LED 318



NEW  
Mini 320



NEW  
Mini Vertical 320



NEW  
Mini Horizontal 320



NEW  
Cut 322



Wilson 323

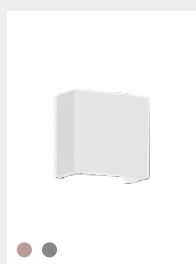

Ges 324

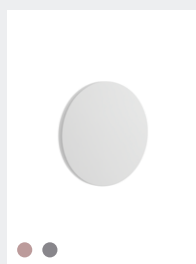

Ges Circular 325

**Superficie de techo**  
**Superficie de teto**  
**326**



Levels

328



Gong

332



Spark

340



Caprice

344



Miso

346



Bol

348



Vetro

349



Prolix

350



Simply

353



Pipe

354



Stylus

355

**Baño**  
**Casa de banho**  
**356**



Perlina

358

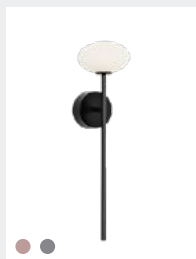

Bloom

360



Dresde LED

362



Toi LED

364



Toilet Slim

366

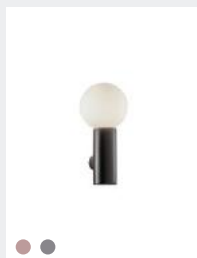

Mist

368



Vetro

370

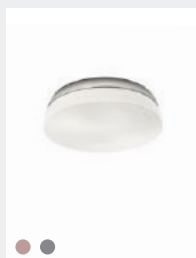

Dec

371



Vanity

372

● Quick Service

● Performance Universe ● Essential Universe

Consulta la explicación completa en P. 034  
Consulte a explicação completa na P. 034

# Fans

## Colección de ventilación Coleção de ventilação 374



**Stem Evo**  
Without light  
386



**Stem Evo**  
With light  
388



**Stem Evo**  
With Play Super Comfort  
390



**Marinada**  
394



**Bosc**  
396



**Pam**  
398



**Helix**  
400



**Bora**  
402



**Calar**  
404

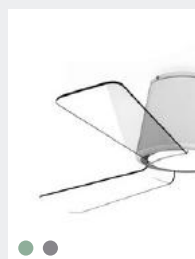

**Garbí**  
406



**July**  
408



**Shadow**  
410



**Zonda**  
412

# Smart lighting

**DALI2  
418**



**Bluetooth  
Casambi  
422**



**DMX  
426**



**Standalone  
428**



# Performance Universe



ES

**Soluciones para proyectos con exigencias lumínicas y de diseño elevadas, donde la luz requiere un alto grado de adaptación a las condiciones del espacio.**

Una propuesta basada en una amplia variedad de ópticas y potencias, opciones avanzadas de acabados y personalización, configuración técnica avanzada, flexibilidad en orientación y configuración.

PT

**Soluções para projetos com exigências lumínicas e de design elevadas, onde a luz requer um alto grau de adaptação às condições do espaço.**

Uma proposta baseada numa ampla variedade de óticas e potências, opções avançadas de acabamentos e personalização, configuração técnica avançada, flexibilidade na orientação e configuração.

# Essential Universe

ES

**Soluciones bien diseñadas, cuidadosamente desarrolladas, pensadas para proyectos con necesidades lumínicas claras y una configuración más directa.**

Una propuesta basada en configuraciones claras y equilibradas, selección optimizada de ópticas y potencias, configuraciones definidas y eficientes, diseño cuidado y fiable.

PT

**Soluções bem concebidas, cuidadosamente desenvolvidas, pensadas para projetos com necessidades lumínicas claras e uma configuração mais direta.**

Uma proposta baseada em configurações claras e equilibradas, seleção otimizada de óticas e potências, configurações definidas e eficientes, conceção cuidada e fiável.



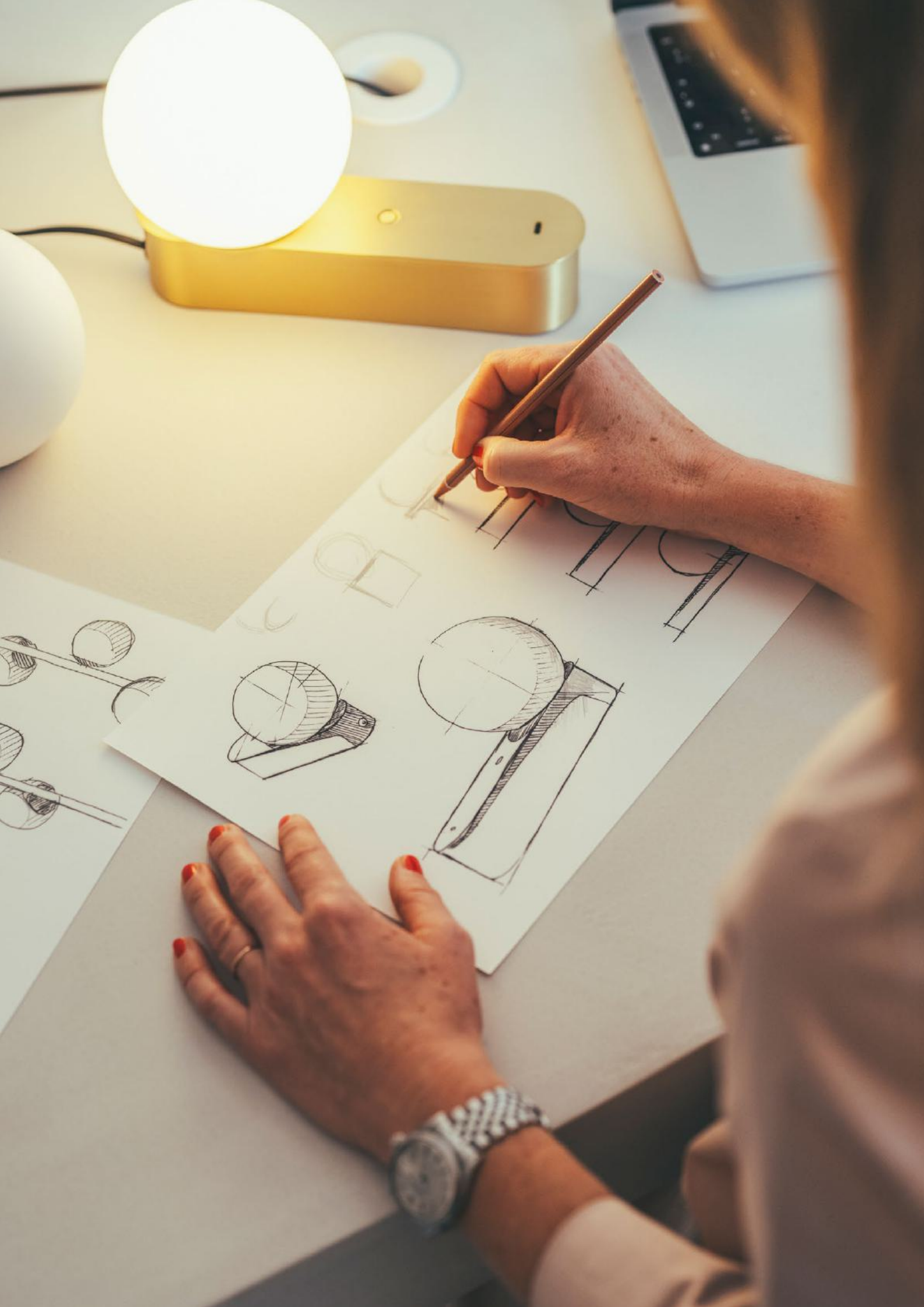

# Servicios

# Serviços

## BESPOKE & CO-CREATION

Colaboramos estrechamente con nuestros clientes en el desarrollo de luminarias especiales a medida, así como en la adaptación de productos existentes. A partir de una necesidad concreta, trabajamos conjuntamente para crear soluciones lumínicas únicas, ajustando diseño, tecnología y prestaciones a los requisitos especiales de cada proyecto.

Trabalhamos em estreita colaboração com os nossos clientes no desenvolvimento de luminárias especiais à medida, assim como na adaptação de produtos existentes. A partir de uma necessidade concreta, trabalhamos em conjunto para criar soluções lumínicas únicas, ajustando o design, a tecnologia e o desempenho aos requisitos especiais de cada projeto.

## TECHNICAL ADVISORY

Desarrollamos de forma integral su proyecto lumínico, desde la definición del concepto hasta la materialización final. Nuestro equipo de expertos trabaja sobre el espacio, el uso y la experiencia, aportando criterio lumínico, desarrollo técnico y soporte especializado en todas las fases, para ofrecer soluciones alineadas con los objetivos del proyecto.

Desenvolvemos de forma integral o seu projeto lumínico, desde a definição do conceito até à materialização final. A nossa equipa de especialistas trabalha em função do espaço, da utilização e da experiência, contribuindo com critérios lumínicos, desenvolvimento técnico e apoio especializado em todas as fases, para oferecer soluções alinhadas com os objetivos do projeto.

## SMART LIGHTING

Acercamos la tecnología para que la iluminación inteligente forme parte natural de cada proyecto. Creamos entornos dinámicos y flexibles que mejoran la experiencia y el bienestar de las personas, incorporando la eficiencia, la sostenibilidad y el ahorro energético. Acompañamos al cliente desde la fase de conceptualización hasta la etapa posterior a la instalación, integrando y configurando sistemas de control y conectividad que permiten una gestión avanzada de la iluminación.

Aproximamos a tecnologia para que a iluminação inteligente se torne uma parte natural de cada projeto. Criamos ambientes dinâmicos e flexíveis que melhoram a experiência e o bem-estar das pessoas, incorporando eficiência, sustentabilidade e poupança energética. Acompanhamos o cliente desde a fase de conceção até à fase pós-instalação, integrando e configurando sistemas de controlo e conectividade que permitem uma gestão avançada da iluminação.

# Sostenibilidad Sustentabilidade

ES

Entendemos la sostenibilidad como un compromiso global que abarca tanto a la empresa como a cada uno de nuestros productos. Trabajamos de forma constante para reducir la huella de carbono de la organización y garantizar una gestión responsable, respaldada por sistemas certificados según las normas ISO 9001 e ISO 14001. Diseñamos luminarias duraderas y eficientes, evaluando su impacto ambiental a lo largo de todo su ciclo de vida para seguir evolucionando y ofrecer soluciones de iluminación cada vez más responsables.

PT

Entendemos a sustentabilidade como um compromisso global que engloba tanto a empresa como cada um dos nossos produtos. Trabalhamos de forma constante para reduzir a pegada de carbono da organização e garantir uma gestão responsável, apoiada por sistemas certificados ISO 9001 e ISO 14001. Concebemos luminárias duradouras e eficientes, avaliando o seu impacto ambiental ao longo de todo o seu ciclo de vida para continuar a evoluir e a oferecer soluções de iluminação cada vez mais responsáveis.





# Decorative

- 028**      **Colecciones modulares**  
Coleções modulares
- 076**      **Suspensión**  
Suspensão
- 178**      **Lectura**  
Leitura
- 208**      **Sobremesa**  
De mesa
- 238**      **Portátil**  
Portátil
- 248**      **Pie**  
Pé
- 272**      **Superficie de pared**  
Superfície de parede
- 326**      **Superficie de techo**  
Superfície de teto
- 356**      **Baño**  
Casa de banho

# Colecciones Modulares

## Coleções Modulares

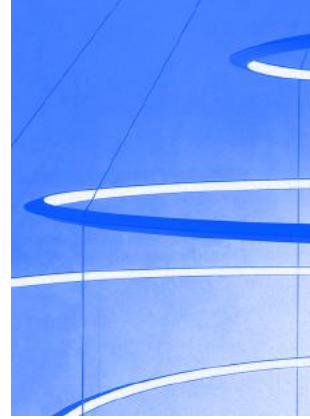

Circular

030

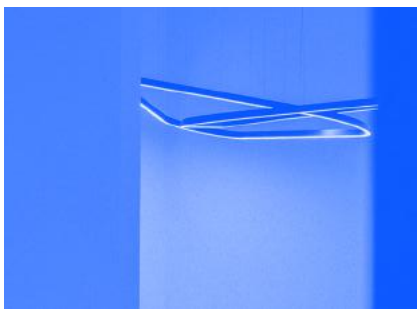

Geometric

038



Hop

046



Scarlett

052

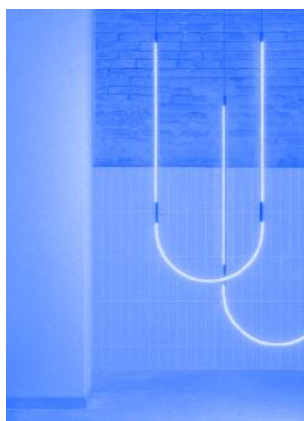

Tubs Modular

058

# Circular



Performance Universe



## La pureza del círculo

Circular es una pieza minimalista que juega con una la luz, haciendo posible que funcione como una luminaria ambiental o funcional debido a la amplitud de variaciones que permite.

Con una clara expresión contemporánea, apuesta por la versatilidad ofreciendo tres direcciones de luz, diferentes medidas y diversidad de composiciones, tanto vertical como horizontal, simple y chandelier.

## A pureza do círculo

Circular é uma peça minimalista que joga com a luz, podendo funcionar como luminária ambiental ou funcional, devido ao vasto leque de variações que permite.

Com uma clara expressão contemporânea, aposta na versatilidade, oferecendo três direções de luz, diferentes medidas e uma diversidade de composições, tanto verticais como horizontais, simples e chandelier.







Con posibilidad de tres direcciones de luz: interior, exterior e inferior.

Com possibilidade de três direções de luz: interior, exterior e inferior.



Todos los modelos disponibles en tres acabados: blanco, negro y dorado. Difusor de silicona.

Todos os modelos disponíveis em três acabamentos: branco, preto e dourado. Difusor de silicone.

# Configura tu Circular Horizontal

## Configure a sua Circular Horizontal

<b>C</b>	<b>F</b> Dirección de la luz Direção da luz	<b>4</b> Instalación Instalação	<b>G</b> Combinaciones estándar Combinações standard	<b>-00</b>	<b>X9</b> Temperatura de la luz Temperatura da luz	<b>AZ</b>	<b>DU</b> Fuente de alimentación Fonte de alimentação	<b>05</b> Acabados Acabamentos
	<b>S</b> Downward <b>D</b> Inward <b>F</b> Outward	<b>4</b> Surface <b>5</b> Recessed	<b>A E K M</b> <b>B F L N</b> <b>C G P</b> <b>D H</b>		<b>V9</b> 2700K <b>W9</b> 3000K <b>X9</b> 4000K		<b>OU</b> ON-OFF <b>DU</b> DALI <b>RU</b> 1-10V	<b>05</b> Black <b>14</b> White <b>EF</b> Gold

### 1 Dirección de la luz

#### Direção da luz

\* Dirección de luz inferior no aplicable a chandeliers con diferentes medidas de aro intercaladas, como F y E.  
\* A direção da luz inferior não é aplicável a lustres com diferentes medidas de aro intercaladas, como F e E.

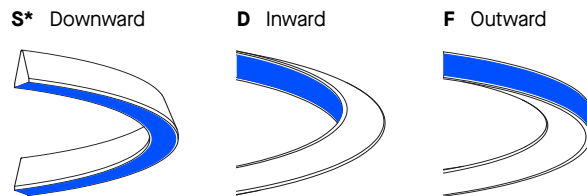

### 2 Instalación

#### Instalação

\* No disponible para los chandelier  
\* No disponible para los chandelier  
\* Los aros Ø2000 (C) y Ø3000 (D) están equipados con 3 sirgas de tensión y 3 canopies como parte de su sistema de instalación.  
\* Los aros Ø2000 (C) y Ø3000 (D) están equipados con 3 sirgas de tensión y 3 canopies como parte de su sistema de instalación.

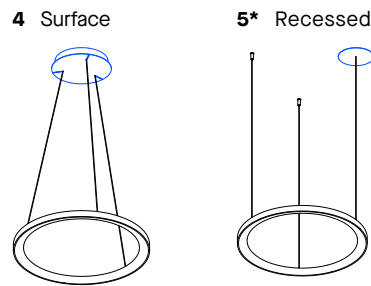

### 3 Medida de aro

#### Medida do aro

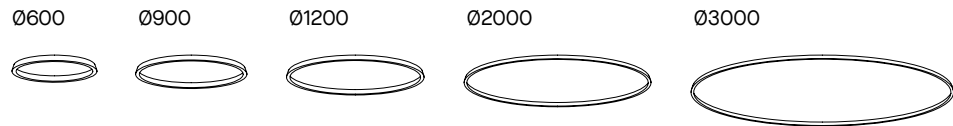

### 4 Temperatura de la luz

#### Temperatura da luz



### 5 Fuentes de alimentación

#### Fonte de alimentação



### 6 Acabados

#### Acabamentos



## Combinaciones estandar

### Combinações standard

### Individual horizontal

### Individual horizontal

Los W indicados en las combinaciones individuales horizontales hacen referencia a la dirección de la luz downward (S).  
Os W indicados nas combinações horizontais individuais referem-se à direção da luz downward (S).

#### A Ø600 mm

Min. 500  
Max. 3000

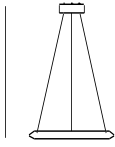

33 W  
1924-3674 lm

#### K Ø900 mm

Min. 700  
Max. 3000

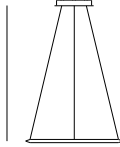

46 W  
2081-4159 lm

#### B Ø1200 mm

Min. 700  
Max. 3000

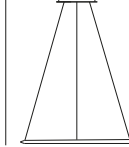

60 W  
3345-6116 lm

#### C Ø2000 mm

Min. 800  
Max. 5000

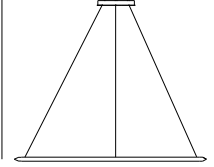

108 W  
5827-10522 lm

#### D Ø3000 mm

Min. 800  
Max. 5000

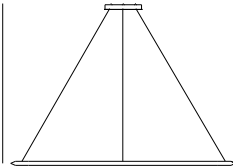

174 W  
8473-15758 lm

#### P Ø2000+2000 mm

Min. 800  
Max. 5000

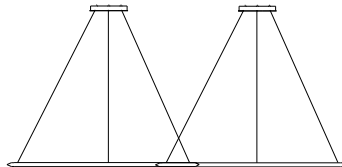

516 W  
11654-21044 lm

### Chandelier horizontal

### Chandelier horizontal

Los W indicados en las combinaciones chandeliers horizontales hacen referencia a la dirección de la luz outward (F).  
Os W indicados nas combinações de lustres horizontais referem-se à direção da luz outward (F).

#### M Ø1200+900 mm

Min. 1000  
Max. 3000  
  
Min. 1500  
Max. 3000

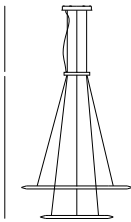

124 W  
5628-9108 lm

#### N Ø900+600 mm

Min. 1000  
Max. 3000  
  
Min. 1500  
Max. 3000

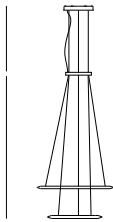

91 W  
4005-6666 lm

#### L Ø1200+900+600 mm

Min. 1000  
Max. 3000  
  
Min. 1500  
Max. 3000

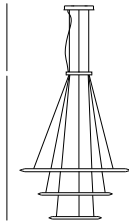

159 W  
7635-12782 lm

#### G Ø3000+2000+1200 mm

Min. 1000  
Max. 4000  
  
Min. 1500  
Max. 3000

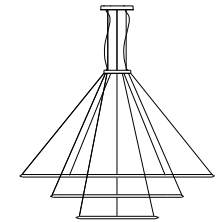

381 W  
14858-32396 lm

#### H Ø2000+1200+600 mm

Min. 1000  
Max. 3000  
  
Min. 1500  
Max. 3000

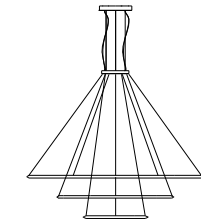

234 W  
11179-20312 lm

#### F Ø600+1200+2000+ 1200+600 mm

Min. 1000  
Max. 3000  
  
Min. 1500  
Max. 2500

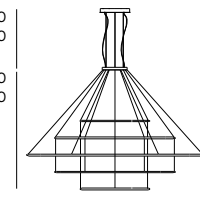

340 W  
16531-30102 lm

#### E Ø1200+2000+3000+ 2000+1200 mm

Min. 1000  
Max. 4000  
  
Min. 2000  
Max. 2500

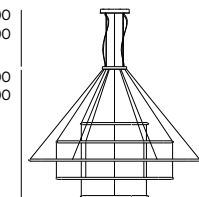

575 W  
26817-49034 lm

# Configura tu Circular Wall

## Configure a sua Circular Wall

NEW

<b>C</b>	<b>F</b> Dirección de la luz Direção da luz	<b>4</b> Instalación Instalação	<b>A</b> Combinaciones estandard Combinações standard	<b>-05</b>	<b>V9</b> Temperatura de la luz Temperatura da luz	<b>AZ</b>	<b>DU</b> Fuente de alimentación Fonte de alimentação	<b>05</b> Acabados Acabamentos
	<b>S</b> Downward <b>D</b> Inward <b>F</b> Outward <b>P</b> Outward	<b>4</b> Surface <b>6</b> Recessed	<b>A</b> Ø600 mm <b>K</b> Ø900 mm		<b>V9</b> 2700K <b>W9</b> 3000K		<b>DU</b> DALI	<b>05</b> Black <b>EF</b> Gold

### 1 Dirección de la luz

#### Direção da luz

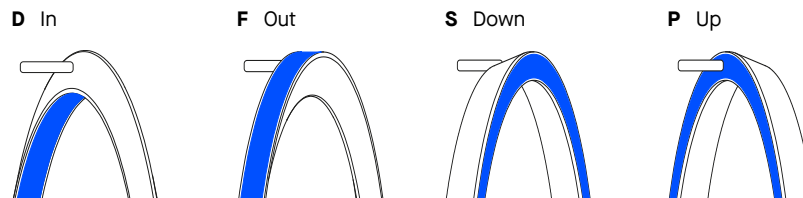

### 2 Instalación

#### Instalação

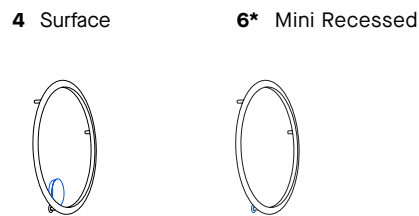

### 3 Medida de aro

#### Medida do aro

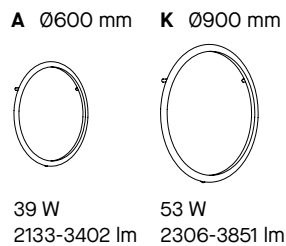

### 4 Temperatura de la luz

#### Temperatura da luz



### 5 Fuentes de alimentación

#### Fonte de alimentação

**DU** DALI  
100-240V

### 6 Acabados

#### Acabamentos

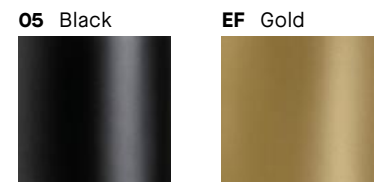

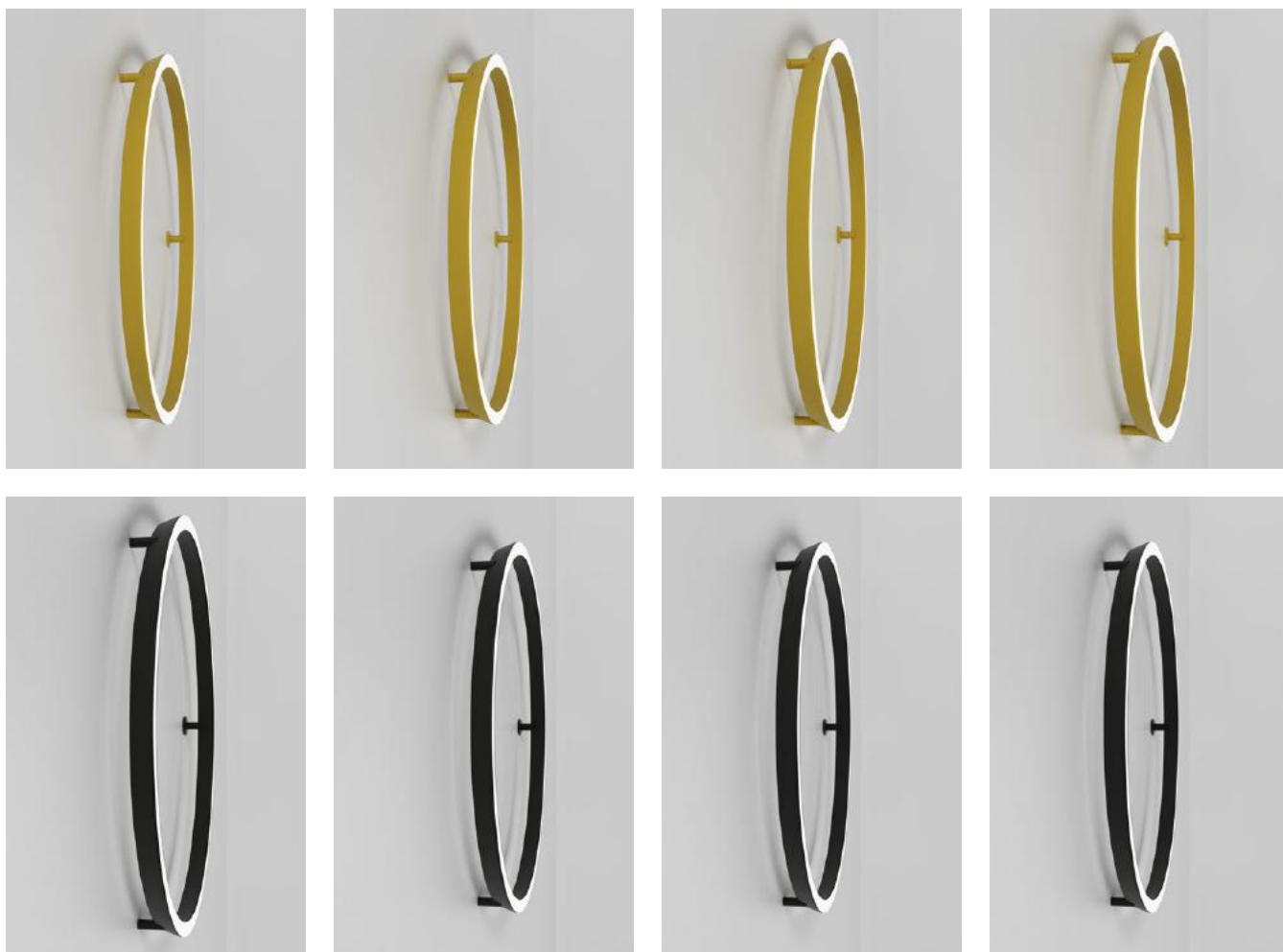

Con posibilidad de tres direcciones de luz: In, Out, Down y Up.  
Com possibilidade de quatro direções de luz: In, Out, Down e Up.

Instalación Surface y Mini Recessed  
Instalação Surface e Mini Recessed

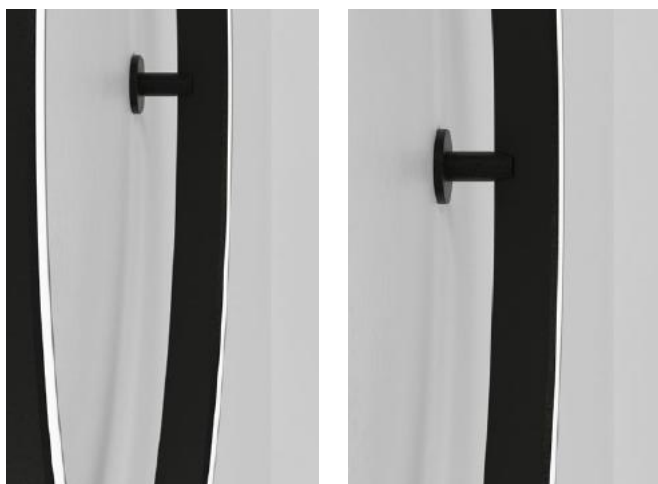

# Geometric



Performance Universe



## Geometría modular

Sin geometría no entendemos la arquitectura y viceversa. Geometric es una colección modular de máximos, con capacidad para adaptar la luz a cualquier espacio. Gracias a las combinaciones de sus componentes, se pueden crear figuras que pueden adaptarse a cada proyecto, pudiendo dirigir y modelar la dirección de la luz.

## Geometria modular

Sem geometria não entendemos a arquitetura e vice-versa. Geometric é uma coleção modular de máximos, com capacidade para adaptar a luz a qualquer espaço. Graças às combinações dos seus componentes, é possível criar figuras que podem ser adaptadas a cada projeto, podendo dirigir e moldar a direção da luz.



# Configura tu Geometric

## Configure a sua Geometric



Configurador para personalización disponible.  
Configurador para personalização disponível.

[geometric.ledsc4.com](http://geometric.ledsc4.com)

<b>T</b> Estructura Estrutura	<b>S</b> Dirección de la luz Direção da luz	<b>4</b> Instalación Instalação	<b>Z</b> Combinaciones estandard Combinações standard	<b>-00</b>	<b>X9</b> Temperatura de la luz Temperatura da luz	<b>AZ</b>	<b>RU</b> Fuente de alimentación Fonte de alimentação	<b>05</b> Acabados Acabamentos
<b>T</b> Triangle <b>Q</b> Square <b>R</b> Rectangle <b>O</b> Oval <b>L</b> Lineal	<b>S</b> Downward	<b>4</b> Surface <b>5</b> Recessed <b>6</b> Mini <b>7</b> Slim <b>8</b> Slim Recessed	<b>S</b> <b>W</b> <b>X</b> <b>Y</b> <b>Z</b>		<b>V9</b> 2700K <b>W9</b> 3000K <b>X9</b> 4000K		<b>OS</b> ON-OFF <b>DS</b> DALI <b>DU</b> DALI <b>RU</b> 1-10V	<b>05</b> Black <b>14</b> White <b>EF</b> Gold

### 1 Estructura Estrutura



### 2 Dirección de la luz Direção da luz

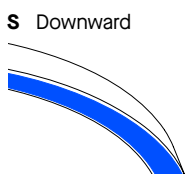

### 3 Instalación Instalação

\*Para esta instalación es necesario el acceso posterior.  
\*O acesso traseiro é necessário para esta instalação.

\*\* En combinaciones estandard solo disponibles para estructuras V, W y L y fuentes de alimentación OS y DS (para más opciones consultar en el configurador).

\*\* Em combinações standard apenas disponíveis para estruturas V, W e L e fontes de alimentação OS e DS (para mais opções, ver configurador).

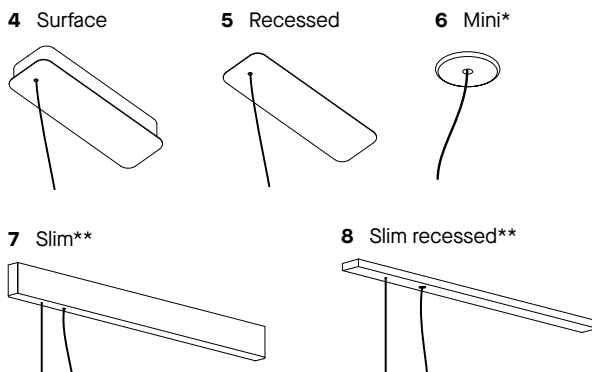

### 4 Temperatura de la luz Temperatura da luz



### 5 Fuentes de alimentación Fonte de alimentação

<b>OS</b> ON/OFF 220-240V	<b>DS</b> DALI 220-240V	<b>DU</b> DALI 100-240V	<b>RU</b> 1-10V 100-240V
------------------------------	----------------------------	----------------------------	-----------------------------

### 6 Acabados Acabamentos



**Combinaciones estandar**  
**Combinações standard**

**TRIANGLES**

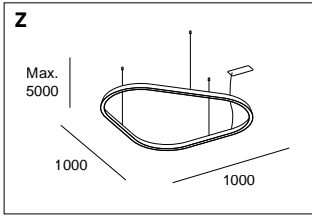

68 W  
3394-4416 lm

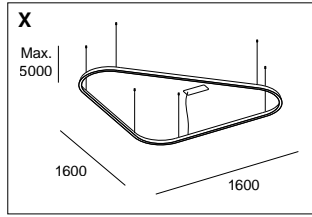

110 W  
5638-7336 lm

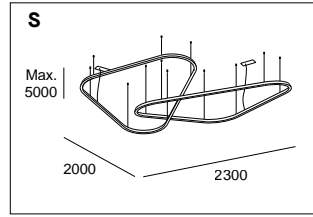

220 W  
11276-14672 lm

**LINEAL**

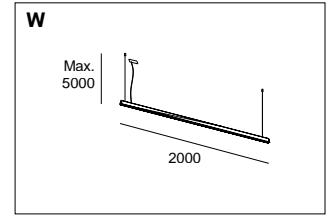

42 W  
2189-2803 lm

**SQUARES**

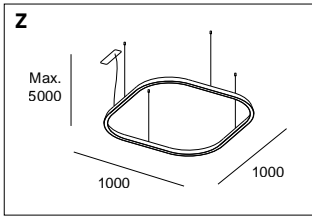

76 W  
3825-4978 lm

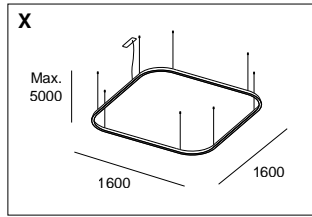

125 W  
6455-8399 lm

**RECTANGLES**

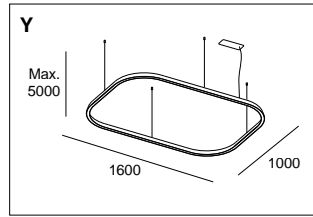

100 W  
5140-6688 lm

**OVAL**

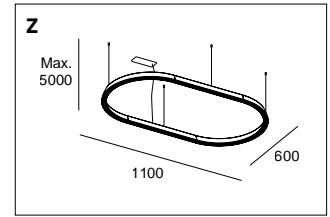

61 W  
3174-4065 lm



# Componentes Configurator

## Componentes Configurator



Para crear figuras libres que se adapten a tu proyecto  
 Para criar figuras livres que se adaptem ao seu projeto

### Rectas

#### Retas

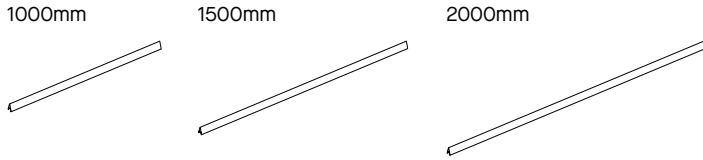

### Curvas

#### Corbas

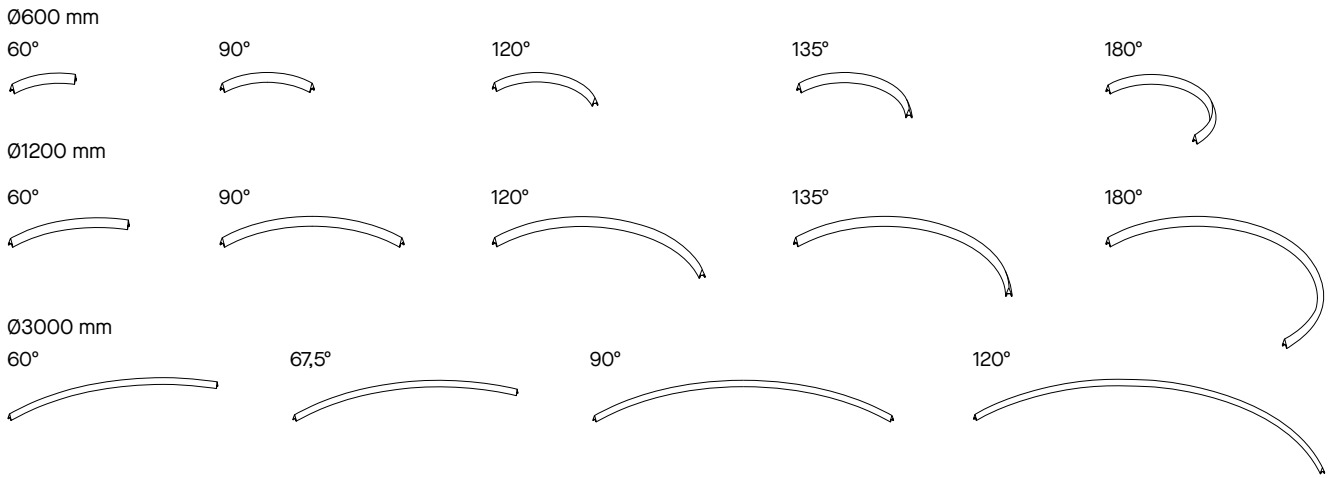

Cada perfil tiene opción:  
 Cada perfil tem opção de:

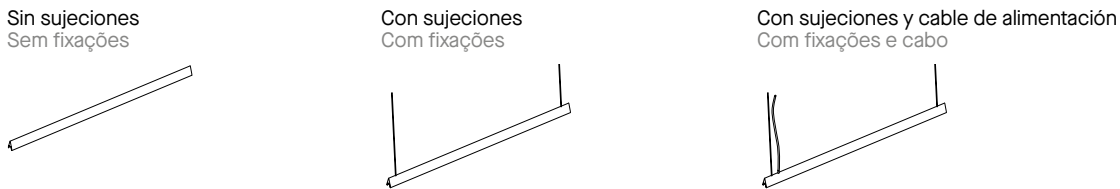

### Posibles combinaciones

#### Posibles combinaciones

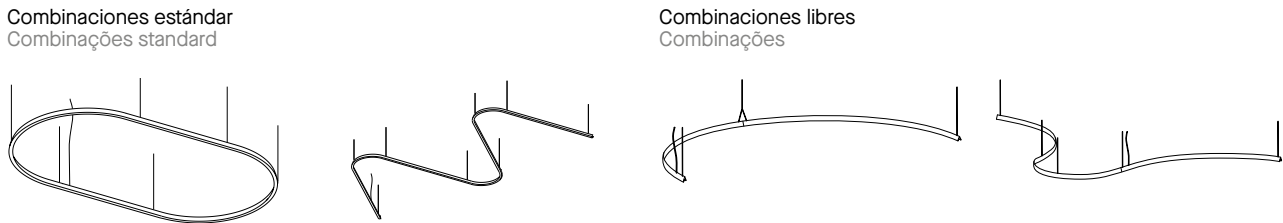

### Florón

#### Florão

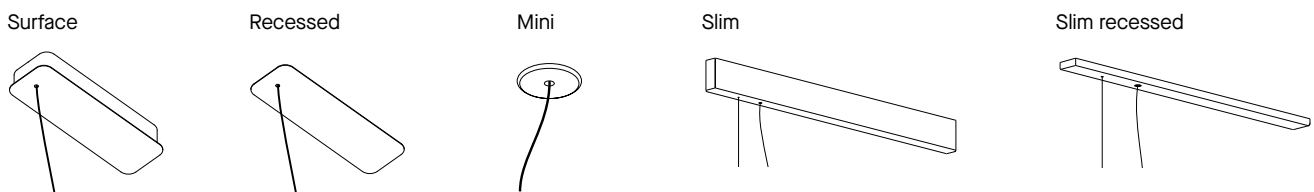





Múltiples combinaciones de estructuras, florones y acabados disponibles.

Múltiplas combinações de estruturas, florões e acabamentos disponíveis.



LS8W-00W9AZOS05



OS4Z-00W9AZOS14



TS4S-00W9AZOS14



QS5Z-00W9AZOS05



QS4X-00V9AZOU05



TS4X-00V9AZOU05

# Hop NEW



## Performance Universe



### **Chandelier contemporâneo modular que aporta dinamismo y ligereza visual.**

Su versatilidad compositiva permite crear múltiples configuraciones, adaptándose a cualquier tipo de ambiente. Los elementos pueden colocarse cerca del techo o suspendidos a diferentes alturas, creando volumen, ritmo y movimiento según el espacio.

Hop combina libertad compositiva con simplicidad estructural, funcionando a partir de un único punto de conexión eléctrica, lo que permite distribuir los elementos de manera flexible.

### **Chandelier contemporâneo modular que confere dinamismo e leveza visual.**

A sua versatilidade compositiva permite a criação de múltiplas configurações, adaptando-se a qualquer tipo de ambiente. Os elementos podem ser colocados junto ao teto ou suspensos a diferentes alturas, criando volume, ritmo e movimento de acordo com o espaço.

Hop combina liberdade de composição com simplicidade estrutural, funcionando a partir de um único ponto de ligação elétrica, o que permite a distribuição dos elementos de forma flexível.



# Configura tu Hop

## Configure a sua Hop

Configuración personalizable, pensada para integrarse con elegancia y originalidad a cualquier proyecto.  
Configuração personalizável, concebida para se integrar com elegância e originalidade em qualquer projeto.

### 1 Elige una conexión/florón

#### Escolher uma ligação/florão

QS



Florón techo pequeño  
Florão de teto pequeno

71-C254-05-05

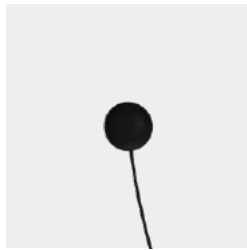

Florón pared pequeño  
Florão de parede pequeno

71-C253-05-05

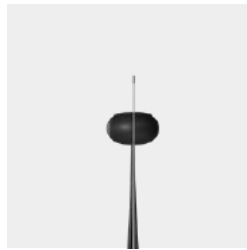

Florón 8 salidas de cable  
Florão com 8 saídas de cabo

71-C262-05-05



Connexión con regulador  
Ligação ao regulador

71-C265-05-05

### 2 Elige uno o más puntos de luz

#### Selecionar um ou mais pontos de luz

QS

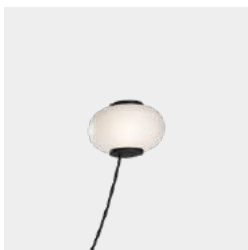

Hop techo  
Hop teto

71-C255-05-05



Hop colgante  
Hop suspensa

71-C256-05-05



Hop techo suspendida  
Hop teto suspensa

71-C255-05-05 +  
71-C259-05-05

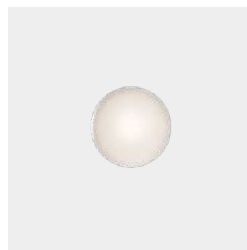

Hop applique  
Hop applique

71-C257-05-05

Las versiones de techo y applique permiten añadir uno o dos cables, ofreciendo mayor libertad compositiva.  
As versões de teto e applique permitem a adição de um ou dois fios, oferecendo uma maior liberdade de composição.

### 3 Elige el cableado

#### Escolher a cablagem

Cable disponible en varias longitudes, ajustable en obra para una adaptación total.  
Cabo disponível em vários comprimentos, ajustável em obra para uma adaptação total.

QS



1.6m  
71-C260-05-05



2.6m  
71-C261-05-05



10m  
71-C263-05-05



25m  
71-C264-05-05

Cable disponible en otros colores bajo consulta.  
Cabo disponível noutras cores, sob consulta.

### 4 Escoge tus accesorios necesarios

#### Escolher os acessórios necessários

QS

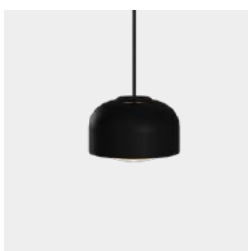

Pantalla metálica Hop  
Tela metálica Hop

71-C258-05-14

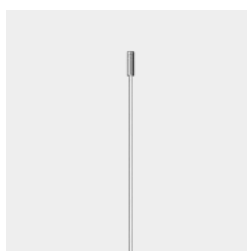

Kit suspensión HOP techo suspendida  
Kit de suspensão HOP teto falso

71-C259-05-05



Sus esferas de vidrio,  
cuidadosamente elaboradas,  
proporcionan una luz  
envolvente y controlada.

As esferas de vidro  
cuidadosamente trabalhadas  
proporcionam uma luz  
envolvente e controlada.



Hop reinventa el clásico  
chandelier con un enfoque  
contemporáneo.

Hop reinventa o clássico  
chandelier com uma abordagem  
contemporânea.

**Combinaciones estandar**  
**Combinações standard**



Aplique Hop 1 luz  
 Hop applique 1 luz  
**05-A109-05-37**

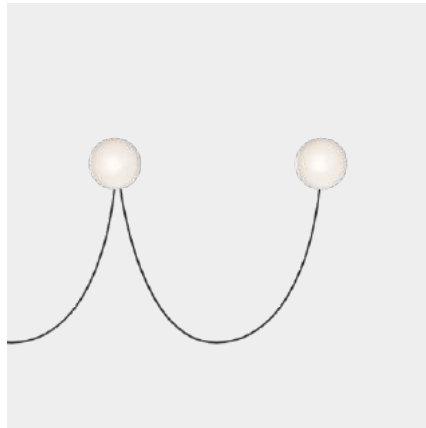

Aplique Hop 2 luces  
 Hop applique 2 luces  
**05-A110-05-37**



Colgante Hop 1 luz  
 Hop suspensa 1 luz  
**00-A372-05-37**

2700K  
 PHASE CUT

2700K  
 PHASE CUT

2700K  
 PHASE CUT



Colgante Hop 1 luz con pantalla  
 Hop suspensa 1 luz con tela  
**00-A373-05-37**



Colgante Hop 2 luces  
 Hop suspensa 2 luces  
**00-A374-05-37**



Colgante Hop 2 luces con pantalla  
 Hop suspensa 2 luces con tela  
**00-A375-05-37**

2700K  
 PHASE CUT

2700K  
 PHASE CUT

2700K  
 PHASE CUT



Colgante Hop 4 luces  
 Hop suspensa 4 luces  
**00-A376-05-37**

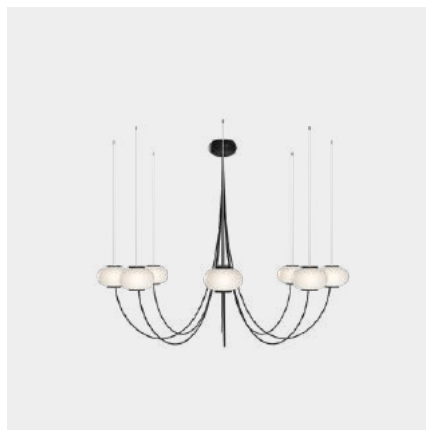

Colgante Hop 8 luces  
 Hop suspensa 8 luces  
**00-A377-05-37**



Colgante Hop 16 luces  
 Hop suspensa 16 luces  
**00-A378-05-37**

2700K  
 PHASE CUT

2700K  
 PHASE CUT

2700K  
 PHASE CUT

# Scarlett



## Performance Universe



Lágrimas de plástico sostenible de origen recuperado.  
Lágrimas de plástico sustentável de origem reciclada.

### Protagonismo de la luz

Scarlett es la actualización de los chandeliers clásicos. Esta nueva colección juega de manera magistral con el color de sus lágrimas y las geometrías esenciales creando elegantes proyecciones de sombras y tonalidades. Además, tiene unas características lumínicas muy funcionales para la iluminación de techos de multitud de ambientes y también permite graduar la temperatura de color según se desee. El diseño se ha llevado a cabo haciendo uso de materiales sostenibles como uno de sus principales puntos fuertes.

Esta colección también puede personalizarse jugando con el tamaño de sus piezas y los diferentes colores disponibles a través del configurador.

### Protagonismo da luz

Scarlett é a atualização dos chandeliers clássicos. Esta nova coleção combina de forma magistral com a cor das suas lágrimas e as geometrias essenciais, criando elegantes projeções de sombras e tons. Além disso, tem características lumínicas muito funcionais para iluminar tetos numa multiplicidade de ambientes e permite também regular a temperatura da cor conforme desejado. O design foi realizado com materiais sustentáveis como um dos seus principais pontos fortes.

Esta coleção também pode ser personalizada combinando com o tamanho das suas peças e com as diferentes cores disponíveis através do configurador.



# Configura tu Scarlett

## Configure a sua Scarlett



Configurador para personalización disponible.  
Configurador para personalização disponível.

[scarlett.ledsc4.com](http://scarlett.ledsc4.com)

<b>S</b>	<b>G</b>	<b>S</b>	<b>I</b>	<b>-A</b>	<b>A</b>	<b>A</b>
	Figura Figura	Instalación Instalação	Construcción Construção	LEVEL 1 Medidas figura Medida figura	LEVEL 2 Medidas figura Medida figura	LEVEL 3 Medidas figura Medida figura
	<b>C</b> Circular <b>Q</b> Square	<b>S</b> Surface <b>P</b> Pendant	<b>I</b> Individual <b>T</b> Tower <b>C</b> Chandelier	<b>A</b> 530mm <b>B</b> 730mm <b>C</b> 930mm <b>O</b> None	<b>A</b> 530mm <b>B</b> 730mm <b>C</b> 930mm <b>O</b> None	<b>A</b> 530mm <b>B</b> 730mm <b>C</b> 930mm <b>O</b> None

### 1 Figura Figura



### 2 Instalación Installation

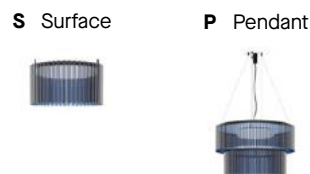

### 3 Construcción Construction

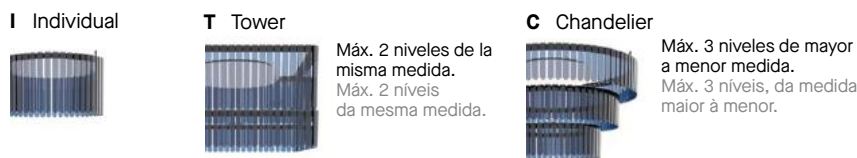

### 4 Medida figuras Medida figuras

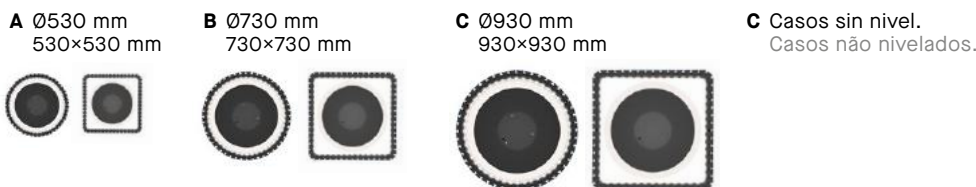

### 5 Medida lágrimas Medida lágrimas



### 6 Acabados Acabamentos

Los acabados pueden sufrir cambios en función de múltiples factores.  
Os acabamentos podem mudar em função de muitos fatores.

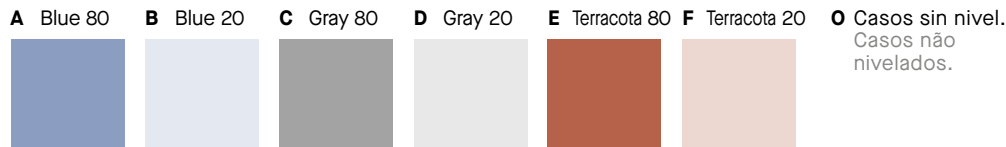

### 7 Fuente de alimentación Fonte de alimentação



### 8 Temperatura de la luz Temperatura da luz

La pieza contiene un switch CCT.  
A peça contém um interruptor CCT.

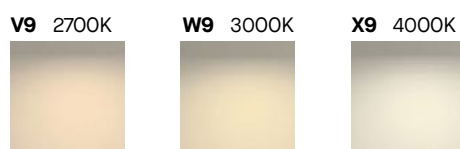

**-SA**

LEVEL 1  
Medida/Acabado lágrima  
Tamanho/Revestimento da lágrima

L 29cm    A D O  
S 17cm    B E  
O None    C F

**SA**

LEVEL 2  
Medida/Acabado lágrima  
Tamanho/Revestimento da lágrima

L 29cm    A D O  
S 17cm    B E  
O None    C F

**SA**

LEVEL 3  
Medida/Acabado lágrima  
Tamanho/Revestimento da lágrima

L 29cm    A D O  
S 17cm    B E  
O None    C F

**-DU**

Fuente de alimentación  
Fonte de alimentação

OS ON-OFF  
DU DALI

**V**

Temperatura de la luz  
Temperatura da luz

V 2700K  
W 3000K  
X 4000K

**Combinaciones estandar**  
**Combinações standard**

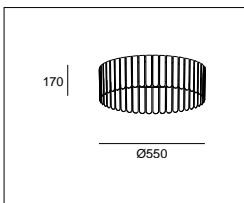

SCSI-A00-SC0000-OSV  
SCPI-A00-SC0000-OSV

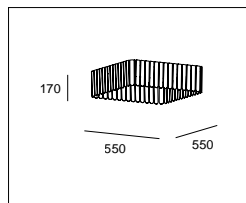

SGSI-A00-SF0000-OSV  
SQPI-A00-SF0000-OSV

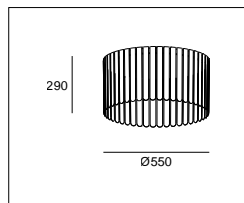

SCSI-A00-LD0000-OSV  
SCPI-A00-LD0000-OSV

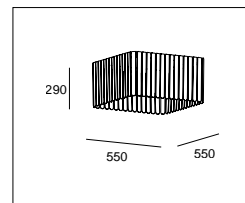

SGSI-A00-LA0000-OSV  
SQPI-A00-LA0000-OSV

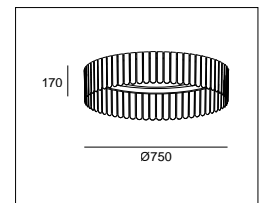

SCSI-B00-SE0000-OSV  
SCPI-B00-SE0000-OSV

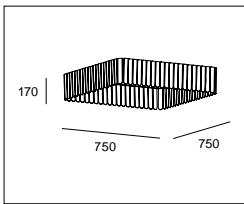

SQSI-B00-SB0000-OSV  
SQPI-B00-SB0000-OSV

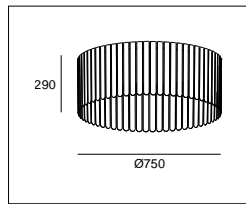

SCSI-B00-LF0000-OSV  
SCPI-B00-LF0000-OSV

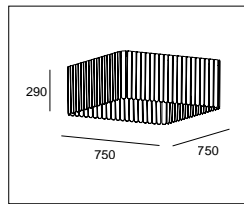

SQSI-B00-LE0000-OSV  
SQPI-B00-LE0000-OSV

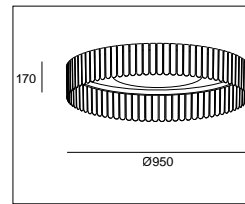

SCSI-C00-SA0000-OSV  
SCPI-C00-SA0000-OSV

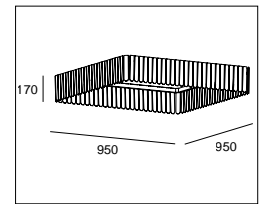

SQSI-C00-SD0000-OSV  
SQPI-C00-SD0000-OSV

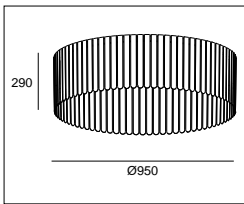

SCSI-C00-LB0000-OSV  
SCPI-C00-LB0000-OSV

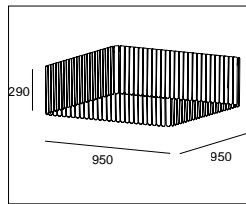

SQSI-C00-LC0000-OSV  
SQPI-C00-LC0000-OSV

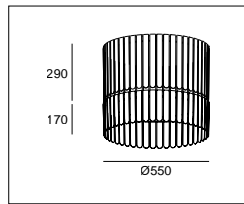

SCST-AA0-LCSD00-OSV  
SQPT-AA0-LCSD00-OSV

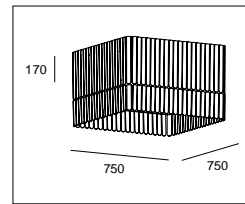

SQST-BB0-LASB00-OSV  
SQPT-BB0-LASB00-OSV

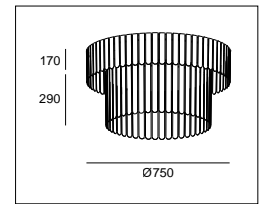

SCSC-BA0-SELFO0-OSV  
SCPC-BA0-SELFO0-OSV

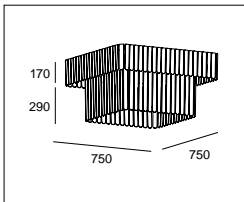

SQSC-BA0-SELFO0-OSV  
SQPC-BA0-SELFO0-OSV

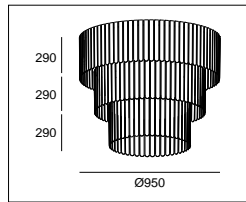

SCSC-CBA-LALALB-OSV  
SCPC-CBA-LALALB-OSV

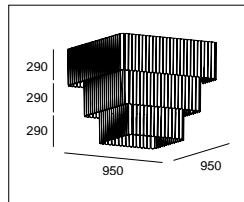

SQSC-CBA-LCLCLD-OSV  
SQPC-CBA-LCLCLD-OSV

**INFORMACIÓN COMÚN**  
**INFORMAÇÃO COMUM**

Surface structure 30mm  
Pendant structure Max.

5000mm  
3737-3907 lm  
55 W

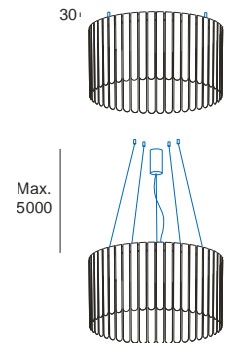



Distintas combinaciones y posibilidades de instalación.  
Diferentes combinações e possibilidades de instalação.



SQPT-BBO-LCSD00-OSV



SCPC-CBO-LFLE00-OSV

Los acabados y tonalidad mostrados pueden no ser completamente precisos debido a ligeras variaciones en la producción, factores de iluminación, fotográficas e impresión.

Os acabamentos e tonalidades apresentados podem não ser totalmente precisos, devido a ligeiras variações na produção, fatores de iluminação fotográfica e de impressão.

# Tubs Modular



Performance Universe



## Tridimensionalidad orgánica

Tubs es un sistema de luz orgánico, capaz de llenar el espacio con una fuerte presencia lumínica o bien de ocupar el vacío con un agradable efecto ambiental. Su dinamismo se basa en esa dualidad, la de poder jugar con la posibilidad de dirigir fácilmente su halo de luz con un efecto directo o trabajar con una luz de reflejo. En todos los casos, su estructura modular es capaz de configurar al gusto su forma gracias a un amplio número de conectores y la gran facilidad con que se unen.

## Tridimensionalidade orgânica

Tubs é um sistema de iluminação orgânico, capaz de preencher o espaço com uma forte presença lumínica ou ocupar o vazio com um agradável efeito ambiente. O seu dinamismo baseia-se nesta dualidade, a de poder jogar com a possibilidade de dirigir facilmente o seu feixe de luz com um efeito direto ou trabalhar com uma luz de reflexão. Em todos os casos, a sua estrutura modular é capaz de configurar a sua forma a gosto, graças a um grande número de conectores e à grande facilidade com que podem ser unidos.



# Configura tu Tubs Modular

## Configure a Tubs Modular

Configurador para personalización disponible.  
Configurador para personalização disponível.

[tubs.ledsc4.com](http://tubs.ledsc4.com)

### 1 Instalación

#### Installation

Ceiling pendant

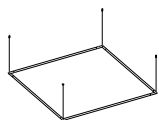

Ceiling/Wall surface

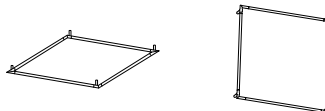

### 2 Florón

#### Florão

\*Para esta instalación es necesario el acceso posterior.  
\*O acesso traseiro é necessário para esta instalação.

Ceiling

Surface

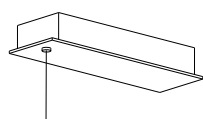

Recessed

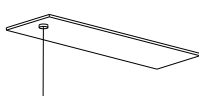

Recessed mini\*



Wall

Potentiometer

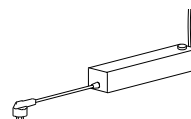

Recessed mini\*



### 3 Componentes

#### Componentes

Tracks



50 mm  
900 mm  
1495 mm

Track connectors



Between levels  
700 mm

Light Tubes



605 mm  
900 mm  
1200 mm  
1495 mm

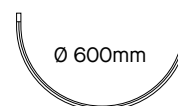

Light Tubes connectors



Initial/final



180°



90°



120°



135°



Triple



Cuadruple

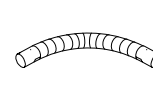

Flexo

Structure connectors



Wall attachment clip



Lights



Spot

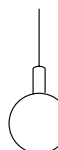

Sphere  
Opal / Transparent

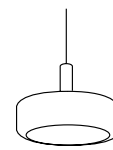

Disc  
Opal / transparent



Pendant with  
honeycomb

### 4 Temperatura de luz

#### Temperatura de luz

2700K



3000K



### 5 Fuente de alimentación

#### Fonte de alimentação

ON/OFF 105 W

DALI 105 W

ON/OFF 180 W

DALI 180 W

ON/OFF 320 W

DALI 320 W



Posibilidad de generar composiciones con distintos niveles de suspensión vertical.  
Possibilidade de gerar composições com diferentes níveis de suspensão vertical.





Sistema de montaje rápido y sencillo.  
Sistema de montagem rápido e fácil.



Tubs Modular cuenta con accesorios en diferentes acabados.  
Tubs Modular possui acessórios em diversos acabamentos.

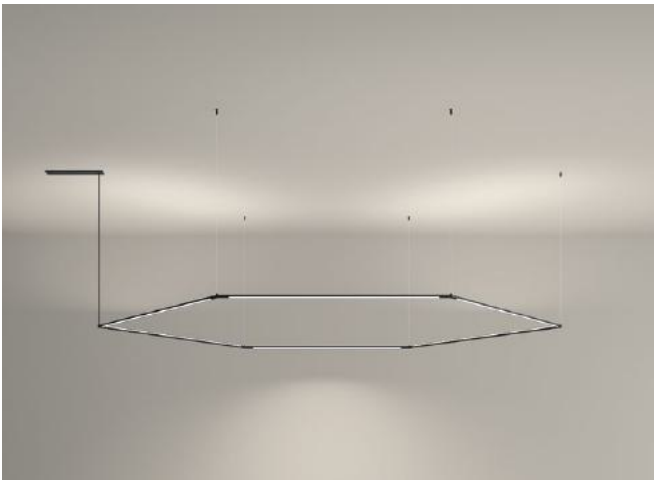

Instalación empotrada.  
Instalação encastrada.

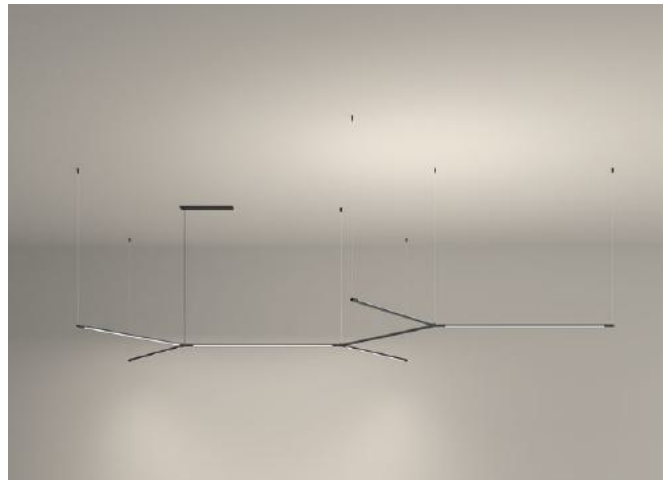

Instalación empotrada.  
Instalação encastrada.



Instalación en superficie.  
Instalação de superfície.



Instalación en superficie.  
Instalação de superfície.

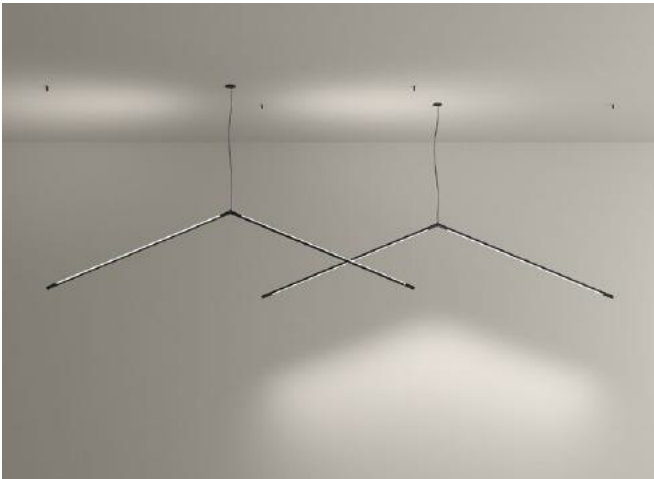

Instalación remota con florón mini.  
Instalação remota com mini florão.

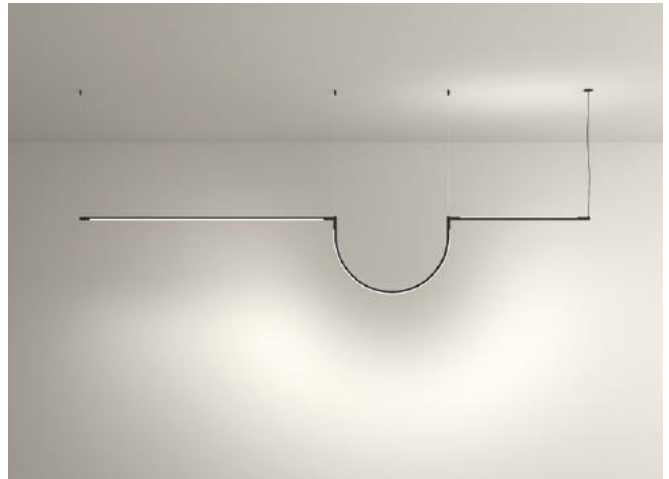

Instalación remota con florón mini.  
Instalação remota com mini florão.

Estructuras colgantes con posibilidad de instalación en superficie o suspensión y con distintas opciones de florón.

Estruturas suspensas com possibilidade de instalação na superfície ou suspensão e com diferentes opções de florão.

Estructuras para pared con distintas opciones de instalación.  
Estruturas para parede com diferentes opções de instalação.



Instalación remota con florón mini.  
Instalação remota com mini florão.



Instalación con caja exterior y enchufe.  
Instalação com caixa exterior e ficha.



Con los paneles de fieltro se pueden crear composiciones personalizables aportando características fonoabsorbentes a la instalación.  
 Com os painéis de fieltro, podem ser criadas composições personalizáveis, fornecendo características fonoabsorbentes à instalação.

GA-GA ● GB-GB ●

No incluidos  
 Não incluídos

	Finishing	Code
	GA ●	<b>71-8498-GA-GA</b>
	GB ●	<b>71-8498-GB-GB</b>
	01 ●	<b>71-8498-GP-01*</b>
	03 ●	<b>71-8498-GP-03*</b>
	05 ●	<b>71-8498-GP-05*</b>
	07 ●	<b>71-8498-GP-07*</b>
	12 ●	<b>71-8498-GP-12*</b>
	22 ●	<b>71-8498-GP-22*</b>
28 ●	<b>71-8498-GP-28*</b>	

	Finishing	Code
	GA ●	<b>71-8497-GA-GA</b>
	GB ●	<b>71-8497-GB-GB</b>
	01 ●	<b>71-8497-GP-01*</b>
	03 ●	<b>71-8497-GP-03*</b>
	05 ●	<b>71-8497-GP-05*</b>
	07 ●	<b>71-8497-GP-07*</b>
	12 ●	<b>71-8497-GP-12*</b>
	22 ●	<b>71-8497-GP-22*</b>
28 ●	<b>71-8497-GP-28*</b>	



Instalación con potenciómetro  
Instalação com potenciômetro

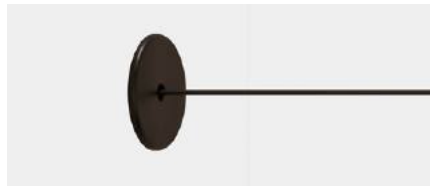

Instalación remota con florón mini empotrado  
Instalação remota com florão mini encastrada

## Tubs Modular Wall Fixture

### Tubs Modular Wall Fixture Lineal Simple

BODY MAT	DIF MAT		
AL	PMMA		360°

Negro Preto 05 ●  
Blanco opal Blanco opalino M1 ○

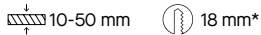
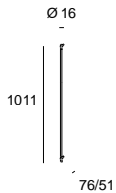

\*Solo para instalación remota.  
Somente para instalação remota.

LED | CRI 92 | W Total 13.1

		K	Real Lm	Structure	Difussor	Code
	PWM 100-240V	2700	1090	05 ●	M1 ○	<b>05-A035-05-M1</b>
	ON-OFF 100-240V	2700	1090	05 ●	M1 ○	<b>05-A036-05-M1</b>
	DALI 100-240V	2700	1090	05 ●	M1 ○	<b>05-A037-05-M1</b>
	PWM 100-240V	3000	1253	05 ●	M1 ○	<b>05-8249-05-M1</b>
	ON-OFF 100-240V	3000	1253	05 ●	M1 ○	<b>05-A015-05-M1 QS</b>
	DALI 100-240V	3000	1253	05 ●	M1 ○	<b>05-A022-05-M1</b>

### Tubs Modular Wall Fixture Lineal Double

BODY MAT	DIF MAT		
AL	PMMA		360°

Negro Preto 05 ●  
Blanco opal Blanco opalino M1 ○

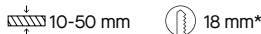
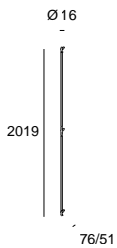

\*Solo para instalación remota.  
Somente para instalação remota.

LED | CRI 92 | W Total 26.2

		K	Real Lm	Structure	Difussor	Code
	PWM 100-240V	2700	2180	05 ●	M1 ○	<b>05-A038-05-M1</b>
	ON-OFF 100-240V	2700	2180	05 ●	M1 ○	<b>05-A039-05-M1 QS</b>
	DALI 100-240V	2700	2180	05 ●	M1 ○	<b>05-A040-05-M1</b>
	PWM 100-240V	3000	2506	05 ●	M1 ○	<b>05-8250-05-M1</b>
	ON-OFF 100-240V	3000	2506	05 ●	M1 ○	<b>05-A016-05-M1 QS</b>
	DALI 100-240V	3000	2506	05 ●	M1 ○	<b>05-A023-05-M1</b>

### Tubs Modular Wall Fixture Square

BODY MAT	DIF MAT		
AL	PMMA		360°

Negro Preto 05 ●  
Blanco opal Blanco opalino M1 ○

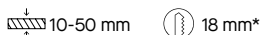
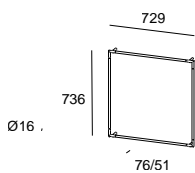



\*Solo para instalación remota.  
Somente para instalação remota.

LED | CRI 92 | W Total 35.2

		K	Real Lm	Structure	Difussor	Code
	PWM 100-240V	2700	2904	05 ●	M1 ○	<b>05-A029-05-M1</b>
	ON-OFF 100-240V	2700	2904	05 ●	M1 ○	<b>05-A030-05-M1 QS</b>
	DALI 100-240V	2700	2904	05 ●	M1 ○	<b>05-A031-05-M1</b>
	PWM 100-240V	3000	3340	05 ●	M1 ○	<b>05-8255-05-M1</b>
	ON-OFF 100-240V	3000	3340	05 ●	M1 ○	<b>05-A013-05-M1 QS</b>
	DALI 100-240V	3000	3340	05 ●	M1 ○	<b>05-A020-05-M1</b>

## Tubs Modular Wall Fixture Combination

BODY MAT	DIF MAT		
AL	PMMA	360°	360°



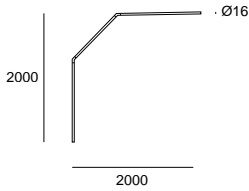



Negro Preto 05 ●  
Blanco opal Branco opalino M1 ○





10-50 mm 18 mm\*

\*Solo para instalación remota.  
Somente para instalação remota.

LED | CRI 92 | W Total 48.1

	K	Real Lm	Structure	Difussor	Code
 PWM 100-240V	2700	3996	05 ●	M1 ○	<b>05-A041-05-M1</b>
 ON-OFF 100-240V	2700	3996	05 ●	M1 ○	<b>05-A042-05-M1 QS</b>
 DALI 100-240V	2700	3996	05 ●	M1 ○	<b>05-A043-05-M1</b>
 PWM 100-240V	3000	4593	05 ●	M1 ○	<b>05-A017-05-M1</b>
 ON-OFF 100-240V	3000	4593	05 ●	M1 ○	<b>05-A018-05-M1 QS</b>
 DALI 100-240V	3000	4593	05 ●	M1 ○	<b>05-A019-05-M1</b>

## Tubs Modular Wall Fixture Molecular

BODY MAT	DIF MAT		
AL	PMMA	360°	360°



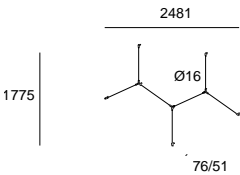



Negro Preto 05 ●  
Blanco opal Branco opalino M1 ○





10-50 mm 18 mm\*

\*Solo para instalación remota.  
Somente para instalação remota.

LED | CRI 92 | W Total 61.6

	K	Real Lm	Structure	Difussor	Code
 PWM 100-240V	2700	5082	05 ●	M1 ○	<b>05-A032-05-M1</b>
 ON-OFF 100-240V	2700	5082	05 ●	M1 ○	<b>05-A033-05-M1 QS</b>
 DALI 100-240V	2700	5082	05 ●	M1 ○	<b>05-A034-05-M1</b>
 PWM 100-240V	3000	5845	05 ●	M1 ○	<b>05-8279-05-M1</b>
 ON-OFF 100-240V	3000	5845	05 ●	M1 ○	<b>05-A014-05-M1 QS</b>
 DALI 100-240V	3000	5845	05 ●	M1 ○	<b>05-A021-05-M1</b>

## Tubs Modular Wall Fixture Reticle

BODY MAT	DIF MAT		
AL	PMMA	360°	360°



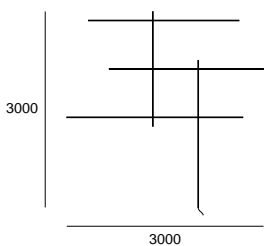

Negro Preto 05 ●  
Blanco opal Branco opalino M1 ○



10-50 mm 18 mm\*

\*Solo para instalación remota.  
Somente para instalação remota.

LED | CRI 92 | W Total 140.3

	K	Real Lm	Structure	Difussor	Code
 ON-OFF 100-240V	2700	11621	05 ●	M1 ○	<b>05-A044-05-M1 QS</b>
 DALI 100-240V	2700	11621	05 ●	M1 ○	<b>05-A045-05-M1</b>
 ON-OFF 100-240V	3000	13361	05 ●	M1 ○	<b>05-A024-05-M1 QS</b>
 DALI 100-240V	3000	13361	05 ●	M1 ○	<b>05-A025-05-M1</b>



Florón superficie  
Florão superfície



Florón empotrado  
Florão encastrado



Instalación remota con florón mini empotrado  
Instalação remota com florão mini encastrada

## Tubs Modular Pendant

### Tubs Modular Pendant Single 600mm

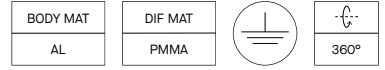

Negro Preto 05 ●  
Blanco opal Branco opalino M1 ○

LED | CRI 92 | W Total 8.8

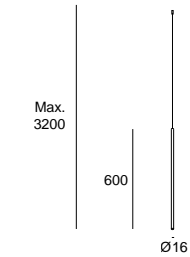

10-50 mm

87 × 244 mm (00-A176/00-A088)  
84 × 314 mm (00-A177/00-A089)

18 mm

		K	Real Lm	Structure	Difusor	Code
	ON-OFF 220-240V	2700	726	05 ●	M1 ○	<b>00-A176-05-M1</b> QS
	DALI 100-240V	2700	726	05 ●	M1 ○	<b>00-A177-05-M1</b>
	ON-OFF 100-240V	2700	726	05 ●	M1 ○	<b>00-A178-05-M1</b> QS
	DALI 100-240V	2700	726	05 ●	M1 ○	<b>00-A179-05-M1</b>
	ON-OFF 220-240V	3000	835	05 ●	M1 ○	<b>00-A088-05-M1</b> QS
	DALI 100-240V	3000	835	05 ●	M1 ○	<b>00-A089-05-M1</b>
	ON-OFF 100-240V	3000	835	05 ●	M1 ○	<b>00-A090-05-M1</b> QS
	DALI 100-240V	3000	835	05 ●	M1 ○	<b>00-A091-05-M1</b>

### Tubs Modular Pendant Single 900mm

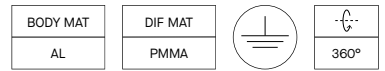

Negro Preto 05 ●  
Blanco opal Branco opalino M1 ○

LED | CRI 92 | W Total 13.1

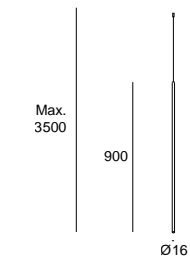

10-50 mm

87 × 244 mm (00-A180/00-A092)  
108 × 314 mm (00-A181/00-A093)

18 mm

		K	Real Lm	Structure	Difusor	Code
	ON-OFF 220-240V	2700	1090	05 ●	M1 ○	<b>00-A180-05-M1</b> QS
	DALI 100-240V	2700	1090	05 ●	M1 ○	<b>00-A181-05-M1</b>
	ON-OFF 100-240V	2700	1090	05 ●	M1 ○	<b>00-A182-05-M1</b> QS
	DALI 100-240V	2700	1090	05 ●	M1 ○	<b>00-A183-05-M1</b>
	ON-OFF 220-240V	3000	1253	05 ●	M1 ○	<b>00-A092-05-M1</b> QS
	DALI 100-240V	3000	1253	05 ●	M1 ○	<b>00-A093-05-M1</b>
	ON-OFF 100-240V	3000	1253	05 ●	M1 ○	<b>00-A094-05-M1</b> QS
	DALI 100-240V	3000	1253	05 ●	M1 ○	<b>00-A095-05-M1</b>

### Tubs Modular Pendant Lineal Double

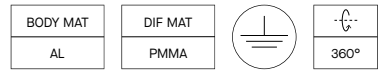

Negro Preto 05 ●  
Blanco opal Branco opalino M1 ○

LED | CRI 92 | W Total 17.6

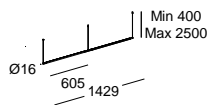

10-50 mm

84 × 314 mm (00-A134/00-8248)  
87 × 244 mm (00-A138/00-8292)

18 mm

		K	Real Lm	Structure	Difusor	Code
	ON-OFF 220-240V	2700	1452	05 ●	M1 ○	<b>00-A138-05-M1</b> QS
	DALI 100-240V	2700	1452	05 ●	M1 ○	<b>00-A134-05-M1</b>
	ON-OFF 100-240V	2700	1452	05 ●	M1 ○	<b>00-A139-05-M1</b> QS
	DALI 100-240V	2700	1452	05 ●	M1 ○	<b>00-A135-05-M1</b>
	ON-OFF 220-240V	3000	1670	05 ●	M1 ○	<b>00-8292-05-M1</b> QS
	DALI 100-240V	3000	1670	05 ●	M1 ○	<b>00-8248-05-M1</b>
	ON-OFF 100-240V	3000	1670	05 ●	M1 ○	<b>00-A060-05-M1</b> QS
	DALI 100-240V	3000	1670	05 ●	M1 ○	<b>00-A058-05-M1</b>

## Tubs Modular Pendant Rectangular Horizontal

BODY MAT	DIF MAT		
AL	PMMA		360°

LED | CRI 92 | W Total 61.4

Negro Preto 05 ●  
Blanco opal Branco opalino M1 ○

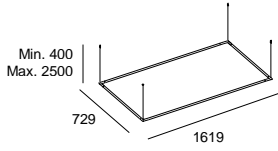

10-50 mm

84 × 314 mm (00-A128/00-8261)  
87 × 244 mm (00-A140/00-8296)

18 mm

		K	Real Lm	Structure	Difusor	Code
	ON-OFF 220-240V	2700	5084	05 ●	M1 ○	<b>00-A140-05-M1 QS</b>
	DALI 100-240V	2700	5084	05 ●	M1 ○	<b>00-A128-05-M1</b>
	ON-OFF 100-240V	2700	5084	05 ●	M1 ○	<b>00-A141-05-M1 QS</b>
	DALI 100-240V	2700	5084	05 ●	M1 ○	<b>00-A129-05-M1</b>
	ON-OFF 220-240V	3000	5846	05 ●	M1 ○	<b>00-8296-05-M1 QS</b>
	DALI 100-240V	3000	5846	05 ●	M1 ○	<b>00-8261-05-M1</b>
	ON-OFF 100-240V	3000	5846	05 ●	M1 ○	<b>00-A061-05-M1 QS</b>
	DALI 100-240V	3000	5846	05 ●	M1 ○	<b>00-A055-05-M1</b>

## Tubs Modular Pendant Rectangular Vertical

BODY MAT	DIF MAT		
AL	PMMA		360°

LED | CRI 92 | W Total 61.4

Negro Preto 05 ●  
Blanco opal Branco opalino M1 ○

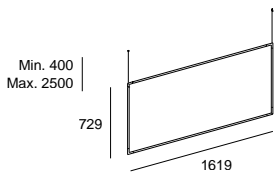

10-50 mm

84 × 314 mm (00-A126/00-8271)  
87 × 244 mm (00-A142/00-8299)

18 mm

		K	Real Lm	Structure	Difusor	Code
	ON-OFF 220-240V	2700	5084	05 ●	M1 ○	<b>00-A142-05-M1 QS</b>
	DALI 100-240V	2700	5084	05 ●	M1 ○	<b>00-A126-05-M1</b>
	ON-OFF 100-240V	2700	5084	05 ●	M1 ○	<b>00-A143-05-M1 QS</b>
	DALI 100-240V	2700	5084	05 ●	M1 ○	<b>00-A127-05-M1</b>
	ON-OFF 220-240V	3000	5846	05 ●	M1 ○	<b>00-8299-05-M1 QS</b>
	DALI 100-240V	3000	5846	05 ●	M1 ○	<b>00-8271-05-M1</b>
	ON-OFF 100-240V	3000	5846	05 ●	M1 ○	<b>00-A062-05-M1 QS</b>
	DALI 100-240V	3000	5846	05 ●	M1 ○	<b>00-A054-05-M1</b>

## Tubs Modular Pendant Double Arch

BODY MAT	DIF MAT		
AL	PMMA		360°

LED | CRI 92 | W Total 71.2

Negro Preto 05 ●  
Blanco opal Branco opalino M1 ○

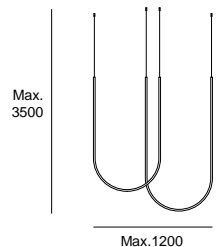

10-50 mm

87 × 244 mm (00-A154/00-A072)  
108 × 314 mm (00-A155/00-A073)

18 mm

		K	Real Lm	Structure	Difusor	Code
	ON-OFF 220-240V	2700	5906	05 ●	M1 ○	<b>00-A154-05-M1 QS</b>
	DALI 100-240V	2700	5906	05 ●	M1 ○	<b>00-A155-05-M1 QS</b>
	ON-OFF 100-240V	2700	5906	05 ●	M1 ○	<b>00-A156-05-M1 QS</b>
	DALI 100-240V	2700	5906	05 ●	M1 ○	<b>00-A157-05-M1 QS</b>
	ON-OFF 220-240V	3000	6792	05 ●	M1 ○	<b>00-A072-05-M1 QS</b>
	DALI 100-240V	3000	6792	05 ●	M1 ○	<b>00-A073-05-M1 QS</b>
	ON-OFF 100-240V	3000	6792	05 ●	M1 ○	<b>00-A074-05-M1 QS</b>
	DALI 100-240V	3000	6792	05 ●	M1 ○	<b>00-A075-05-M1 QS</b>

\*Limitación solo para instalación con florón Mini Recessed.  
\*Limitado apenas para instalação com florão Mini Recessed.

### Tubs Modular Pendant Triplex Arch Cross

BODY MAT	DIF MAT	
AL	PMMA	

Negro Preto 05 ●  
Blanco opal Branco opalino M1 ○

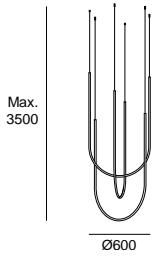

10-50 mm

87 × 244 mm (00-A158/00-A076)  
108 × 314 mm (00-A159/00-A077)

18 mm

LED | CRI 92 | W Total 119.7

	K	Real Lm	Structure	Difusor	Code
	ON-OFF 220-240V	2700	9951	05 ● M1 ○	<b>00-A158-05-M1</b> QS
	DALI 100-240V	2700	9951	05 ● M1 ○	<b>00-A159-05-M1</b> QS
	ON-OFF 100-240V	2700	9951	05 ● M1 ○	<b>00-A166-05-M1</b> QS
	DALI 100-240V	2700	9951	05 ● M1 ○	<b>00-A167-05-M1</b> QS
	ON-OFF 220-240V	3000	11442	05 ● M1 ○	<b>00-A076-05-M1</b> QS
	DALI 100-240V	3000	11442	05 ● M1 ○	<b>00-A077-05-M1</b> QS
	ON-OFF 100-240V	3000	11442	05 ● M1 ○	<b>00-A078-05-M1</b> QS
	DALI 100-240V	3000	11442	05 ● M1 ○	<b>00-A079-05-M1</b> QS

### Tubs Modular Pendant Lineal Single with Arch

BODY MAT	DIF MAT	
AL	PMMA	

Negro Preto 05 ●  
Blanco opal Branco opalino M1 ○

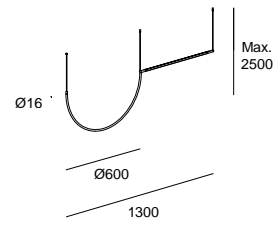

10-50 mm

87 × 244 mm (00-A146/00-A064)  
108 × 314 mm (00-A147/00-A065)

18 mm

LED | CRI 92 | W Total 26.8

	K	Real Lm	Structure	Difusor	Code
	ON-OFF 220-240V	2700	1863	05 ● M1 ○	<b>00-A146-05-M1</b> QS
	DALI 100-240V	2700	2227	05 ● M1 ○	<b>00-A147-05-M1</b>
	ON-OFF 100-240V	2700	1863	05 ● M1 ○	<b>00-A148-05-M1</b> QS
	DALI 100-240V	2700	2227	05 ● M1 ○	<b>00-A149-05-M1</b> QS
	ON-OFF 220-240V	3000	2561	05 ● M1 ○	<b>00-A064-05-M1</b> QS
	DALI 100-240V	3000	2561	05 ● M1 ○	<b>00-A065-05-M1</b> QS
	ON-OFF 100-240V	3000	2143	05 ● M1 ○	<b>00-A066-05-M1</b> QS
	DALI 100-240V	3000	2561	05 ● M1 ○	<b>00-A067-05-M1</b> QS

### Tubs Modular Pendant Lineal Double with Arch

BODY MAT	DIF MAT	
AL	PMMA	

Negro Preto 05 ●  
Blanco opal Branco opalino M1 ○

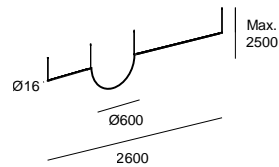

10-50 mm

87 × 244 mm (00-A150/00-A068)  
108 × 314 mm (00-A151/00-A069)

18 mm

LED | CRI 92 | W Total 40

	K	Real Lm	Structure	Difusor	Code
	ON-OFF 220-240V	2700	3316	05 ● M1 ○	<b>00-A150-05-M1</b> QS
	DALI 100-240V	2700	3316	05 ● M1 ○	<b>00-A151-05-M1</b> QS
	ON-OFF 100-240V	2700	3316	05 ● M1 ○	<b>00-A152-05-M1</b> QS
	DALI 100-240V	2700	3316	05 ● M1 ○	<b>00-A153-05-M1</b> QS
	ON-OFF 220-240V	3000	3813	05 ● M1 ○	<b>00-A068-05-M1</b> QS
	DALI 100-240V	3000	3813	05 ● M1 ○	<b>00-A069-05-M1</b> QS
	ON-OFF 100-240V	3000	3813	05 ● M1 ○	<b>00-A070-05-M1</b> QS
	DALI 100-240V	3000	3813	05 ● M1 ○	<b>00-A071-05-M1</b> QS

## Tubs Modular Pendant Lineal Triangular

BODY MAT	DIF MAT		
AL	PMMA		360°

Negro Preto 05 ●  
Blanco opal Branco opalino M1 ○

LED | CRI 92 | W Total 26.4

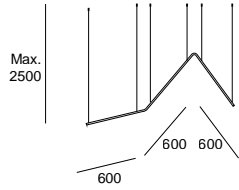

10-50 mm

87 × 244 mm (00-A168/00-A080)  
108 × 314 mm (00-A169/00-A081)

18 mm

		K	Real Lm	Structure	Difussor	Code
	ON-OFF 220-240V	2700	2178	05 ●	M1 ○	<b>00-A168-05-M1</b> QS
	DALI 100-240V	2700	2178	05 ●	M1 ○	<b>00-A169-05-M1</b>
	ON-OFF 100-240V	2700	2178	05 ●	M1 ○	<b>00-A170-05-M1</b> QS
	DALI 100-240V	2700	2178	05 ●	M1 ○	<b>00-A171-05-M1</b>
	ON-OFF 220-240V	3000	2505	05 ●	M1 ○	<b>00-A080-05-M1</b> QS
	DALI 100-240V	3000	2505	05 ●	M1 ○	<b>00-A081-05-M1</b>
	ON-OFF 100-240V	3000	2505	05 ●	M1 ○	<b>00-A082-05-M1</b> QS
	DALI 100-240V	3000	2505	05 ●	M1 ○	<b>00-A083-05-M1</b>

## Tubs Modular Pendant Double Triangular

BODY MAT	DIF MAT		
AL	PMMA		360°

Negro Preto 05 ●  
Blanco opal Branco opalino M1 ○

LED | CRI 92 | W Total 52.4

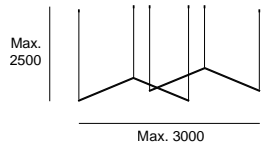

10-50 mm

87 × 244 mm (00-A172/00-A084)  
108 × 314 mm (00-A173/00-A085)

18 mm

		K	Real Lm	Structure	Difussor	Code
	ON-OFF 220-240V	2700	4360	05 ●	M1 ○	<b>00-A172-05-M1</b> QS
	DALI 100-240V	2700	4360	05 ●	M1 ○	<b>00-A173-05-M1</b>
	ON-OFF 100-240V	2700	4360	05 ●	M1 ○	<b>00-A174-05-M1</b> QS
	DALI 100-240V	2700	4360	05 ●	M1 ○	<b>00-A175-05-M1</b>
	ON-OFF 220-240V	3000	5012	05 ●	M1 ○	<b>00-A084-05-M1</b> QS
	DALI 100-240V	3000	5012	05 ●	M1 ○	<b>00-A085-05-M1</b>
	ON-OFF 100-240V	3000	5012	05 ●	M1 ○	<b>00-A086-05-M1</b> QS
	DALI 100-240V	3000	5012	05 ●	M1 ○	<b>00-A087-05-M1</b>

## Tubs Modular Pendant Hexagonal

BODY MAT	DIF MAT		
AL	PMMA		360°

Negro Preto 05 ●  
Blanco opal Branco opalino M1 ○

LED | CRI 92 | W Total 78.6

Min. 400  
Max. 2500

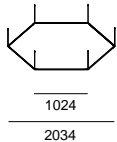

10-50 mm

92 × 304 mm

18 mm

		K	Real Lm	Structure	Difussor	Code
	DALI 100-240V	2700	6540	05 ●	M1 ○	<b>00-A130-05-M1</b>
	DALI 100-240V	3000	7518	05 ●	M1 ○	<b>00-8276-05-M1</b>
	DALI 100-240V	2700	6540	05 ●	M1 ○	<b>00-A131-05-M1</b>
	DALI 100-240V	3000	7518	05 ●	M1 ○	<b>00-A056-05-M1</b>

### Tubs Modular Pendant Molecular

BODY MAT	DIF MAT	
AL	PMMA	

Negro Preto 05 ●  
Blanco opal Branco opalino M1 ○

LED | CRI 92 | W Total 99.4

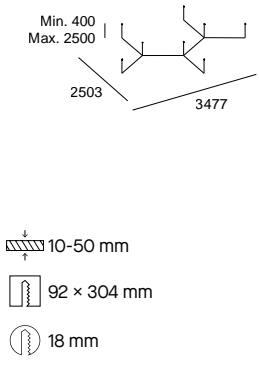

	K	Real Lm	Structure	Difussor	Code
DALI 100-240V	2700	5450	05 ●	M1 ○	<b>00-A132-05-M1</b>
DALI 100-240V	3000	58771	05 ●	M1 ○	<b>00-8280-05-M1</b>
DALI 100-240V	2700	5450	05 ●	M1 ○	<b>00-A133-05-M1</b>
DALI 100-240V	3000	58771	05 ●	M1 ○	<b>00-A057-05-M1</b>

### Tubs Modular Pendant Configuration Lineal x 5

BODY MAT	DIF MAT	
AL	PMMA	

Negro Preto 05 ●  
Blanco opal Branco opalino M1 ○

LED | CRI 92 | W Total 44

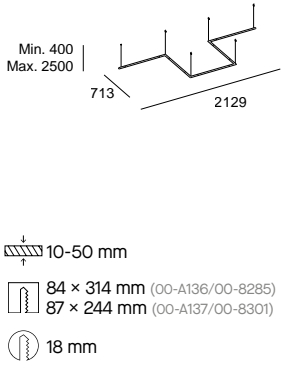

	K	Real Lm	Structure	Difussor	Code
ON-OFF 220-240V	2700	3630	05 ●	M1 ○	<b>00-A144-05-M1</b> QS
DALI 100-240V	2700	3630	05 ●	M1 ○	<b>00-A136-05-M1</b>
ON-OFF 100-240V	2700	3630	05 ●	M1 ○	<b>00-A145-05-M1</b> QS
DALI 100-240V	2700	3630	05 ●	M1 ○	<b>00-A137-05-M1</b>
ON-OFF 220-240V	3000	4175	05 ●	M1 ○	<b>00-8301-05-M1</b> QS
DALI 100-240V	3000	4175	05 ●	M1 ○	<b>00-8285-05-M1</b>
ON-OFF 100-240V	3000	4175	05 ●	M1 ○	<b>00-A063-05-M1</b> QS
DALI 100-240V	3000	4175	05 ●	M1 ○	<b>00-A059-05-M1</b>

### Tubs Modular Pendant Track with 4 Spotlights

BODY MAT	DIF MAT	
AL	PMMA	

Negro Preto 05 ●  
Blanco opal Branco opalino M1 ○

LED | CRI 92 | W Total 15

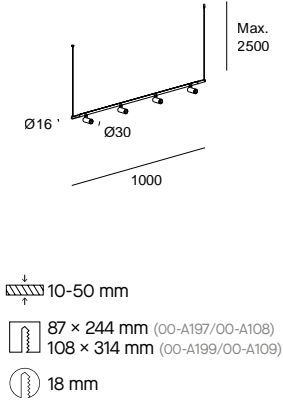

	K	Real Lm	Structure	Difussor	Code
ON-OFF 220-240V	2700	1152	05 ●	M1 ○	<b>00-A196-05-M1</b> QS
DALI 100-240V	2700	1152	05 ●	M1 ○	<b>00-A197-05-M1</b>
ON-OFF 100-240V	2700	1152	05 ●	M1 ○	<b>00-A198-05-M1</b> QS
DALI 100-240V	2700	1152	05 ●	M1 ○	<b>00-A199-05-M1</b>
ON-OFF 220-240V	3000	1204	05 ●	M1 ○	<b>00-A108-05-M1</b> QS
DALI 100-240V	3000	1204	05 ●	M1 ○	<b>00-A109-05-M1</b>
ON-OFF 100-240V	3000	1204	05 ●	M1 ○	<b>00-A110-05-M1</b> QS
DALI 100-240V	3000	1324	05 ●	M1 ○	<b>00-A111-05-M1</b>

## Tubs Modular Pendant Track with 3 Disc

BODY MAT	DIF MAT		
AL	PMMA		360°

Negro Preto 05 ●  
Blanco opal Branco opalino M1 ○

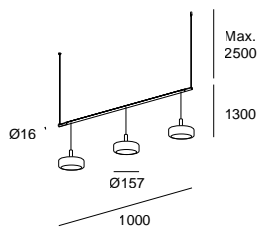

10-50 mm

87 × 244 mm (00-A200/00-A112)  
108 × 314 mm (00-A201/00-A113)

18 mm

### LED | CRI 92 | W Total 16

		K	Real Lm	Structure	Difussor	Code
	ON-OFF 220-240V	2700	183	05 ●	M1 ○	<b>00-A200-05-M1 QS</b>
	DALI 100-240V	2700	183	05 ●	M1 ○	<b>00-A201-05-M1</b>
	ON-OFF 100-240V	2700	183	05 ●	M1 ○	<b>00-A202-05-M1 QS</b>
	DALI 100-240V	2700	183	05 ●	M1 ○	<b>00-A203-05-M1</b>
	ON-OFF 220-240V	3000	210	05 ●	M1 ○	<b>00-A112-05-M1 QS</b>
	DALI 100-240V	3000	192	05 ●	M1 ○	<b>00-A113-05-M1</b>
	ON-OFF 100-240V	3000	210	05 ●	M1 ○	<b>00-A114-05-M1 QS</b>
	DALI 100-240V	3000	192	05 ●	M1 ○	<b>00-A115-05-M1</b>

## Tubs Modular Pendant Track with 5 Spheres

BODY MAT	DIF MAT		
AL	PMMA		360°

Negro Preto 05 ●  
Blanco opal Branco opalino M1 ○

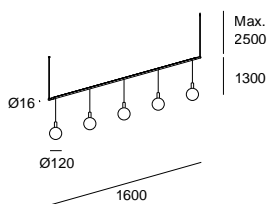

10-50 mm

87 × 244 mm (00-A204/00-A116)  
108 × 314 mm (00-A205/00-A117)

18 mm

### LED | CRI 92 | W Total 26.5

		K	Real Lm	Structure	Difussor	Code
	ON-OFF 220-240V	2700	305	05 ●	M1 ○	<b>00-A204-05-M1 QS</b>
	DALI 100-240V	2700	305	05 ●	M1 ○	<b>00-A205-05-M1</b>
	ON-OFF 100-240V	2700	305	05 ●	M1 ○	<b>00-A206-05-M1 QS</b>
	DALI 100-240V	2700	305	05 ●	M1 ○	<b>00-A207-05-M1</b>
	ON-OFF 220-240V	3000	350	05 ●	M1 ○	<b>00-A116-05-M1 QS</b>
	DALI 100-240V	3000	320	05 ●	M1 ○	<b>00-A117-05-M1</b>
	ON-OFF 100-240V	3000	350	05 ●	M1 ○	<b>00-A118-05-M1 QS</b>
	DALI 100-240V	3000	320	05 ●	M1 ○	<b>00-A119-05-M1</b>

## Tubs Modular Pendant Lineal with 3 Downlights

BODY MAT	DIF MAT		
AL	PMMA		360°

Negro Preto 05 ●  
Blanco opal Branco opalino M1 ○

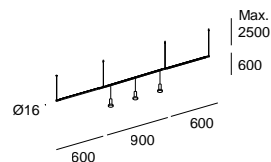

10-50 mm

87 × 244 mm (00-A192/00-A104)  
108 × 314 mm (00-A193/00-A105)

18 mm

### LED | CRI 92 | W Total 33.5

		K	Real Lm	Structure	Difussor	Code
	ON-OFF 220-240V	2700	1638	05 ●	M1 ○	<b>00-A192-05-M1 QS</b>
	DALI 100-240V	2700	1638	05 ●	M1 ○	<b>00-A193-05-M1</b>
	ON-OFF 100-240V	2700	1638	05 ●	M1 ○	<b>00-A194-05-M1 QS</b>
	DALI 100-240V	2700	1638	05 ●	M1 ○	<b>00-A195-05-M1</b>
	ON-OFF 220-240V	3000	1880	05 ●	M1 ○	<b>00-A104-05-M1 QS</b>
	DALI 100-240V	3000	1880	05 ●	M1 ○	<b>00-A105-05-M1</b>
	ON-OFF 100-240V	3000	1880	05 ●	M1 ○	<b>00-A106-05-M1 QS</b>
	DALI 100-240V	3000	1880	05 ●	M1 ○	<b>00-A107-05-M1</b>

### Tubs Modular Pendant Track with 2 Lineal

BODY MAT	DIF MAT	
AL	PMMA	

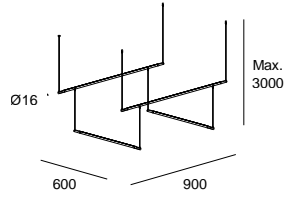

- 10-50 mm
- 87 x 244 mm (00-A184/00-A096)
- 108 x 314 mm (00-A185-00-A097)
- 18 mm

LED | CRI 92 | W Total 17.6

Negro Preto 05 ●  
Blanco opal Branco opalino M1 ○

		K	Real Lm	Structure	Difussor	Code
	ON-OFF 220-240V	2700	1452	05 ●	M1 ○	<b>00-A184-05-M1</b> <b>QS</b>
	DALI 100-240V	2700	1452	05 ●	M1 ○	<b>00-A185-05-M1</b>
	ON-OFF 100-240V	2700	1452	05 ●	M1 ○	<b>00-A186-05-M1</b> <b>QS</b>
	DALI 100-240V	2700	1452	05 ●	M1 ○	<b>00-A187-05-M1</b>
	ON-OFF 220-240V	3000	1670	05 ●	M1 ○	<b>00-A096-05-M1</b> <b>QS</b>
	DALI 100-240V	3000	1670	05 ●	M1 ○	<b>00-A097-05-M1</b>
	ON-OFF 100-240V	3000	1670	05 ●	M1 ○	<b>00-A098-05-M1</b> <b>QS</b>
	DALI 100-240V	3000	1670	05 ●	M1 ○	<b>00-A099-05-M1</b>

### Tubs Modular Pendant Track with 3 Lineal

BODY MAT	DIF MAT	
AL	PMMA	

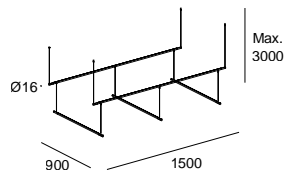

- 10-50 mm
- 87 x 244 mm (00-A188/00-A100)
- 108 x 314 mm (00-A189/00-A101)
- 18 mm

LED | CRI 92 | W Total 39.3

Negro Preto 05 ●  
Blanco opal Branco opalino M1 ○

		K	Real Lm	Structure	Difussor	Code
	ON-OFF 220-240V	2700	3270	05 ●	M1 ○	<b>00-A188-05-M1</b> <b>QS</b>
	DALI 100-240V	2700	3270	05 ●	M1 ○	<b>00-A189-05-M1</b>
	ON-OFF 100-240V	2700	3270	05 ●	M1 ○	<b>00-A190-05-M1</b> <b>QS</b>
	DALI 100-240V	2700	3270	05 ●	M1 ○	<b>00-A191-05-M1</b>
	ON-OFF 220-240V	3000	3759	05 ●	M1 ○	<b>00-A100-05-M1</b> <b>QS</b>
	DALI 100-240V	3000	3759	05 ●	M1 ○	<b>00-A101-05-M1</b>
	ON-OFF 100-240V	3000	3759	05 ●	M1 ○	<b>00-A102-05-M1</b> <b>QS</b>
	DALI 100-240V	3000	3759	05 ●	M1 ○	<b>00-A103-05-M1</b>

# Suspensión

## Suspensão



Voiles

082



Levels

086



llargi

092



Plat

098

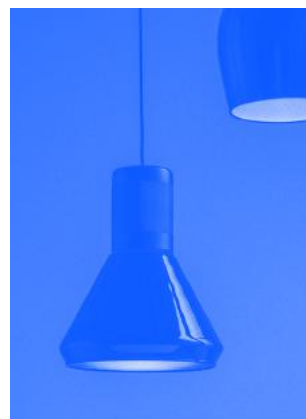

Iris

095



**Khoi**

**100**



**Glam**

**102**



**Gong**

**104**



**Veneto**

**120**



**Coco**

**112**

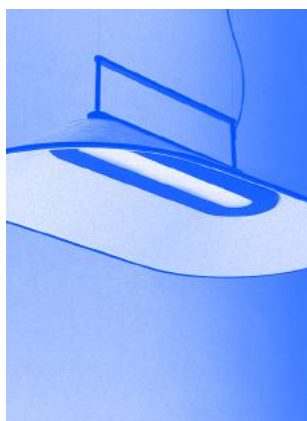

**Shoemaker**

**116**



Nimes

122

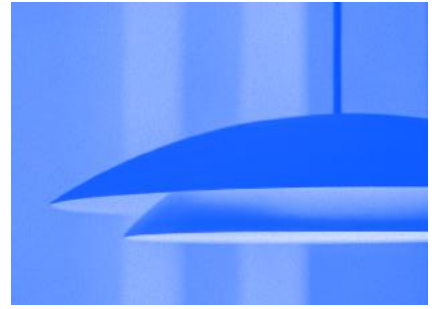

Noway

124



Keops

126



Attic

129

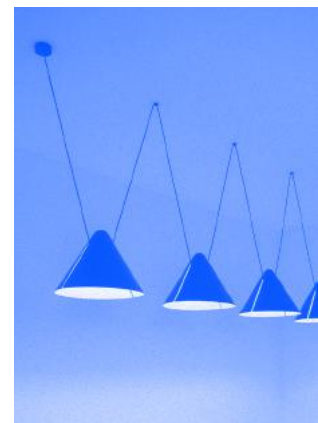

Super Attic

136

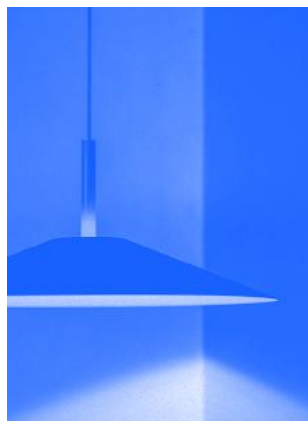

H

140



**Candle 145**



**Napa 143**



**Invisible 151**

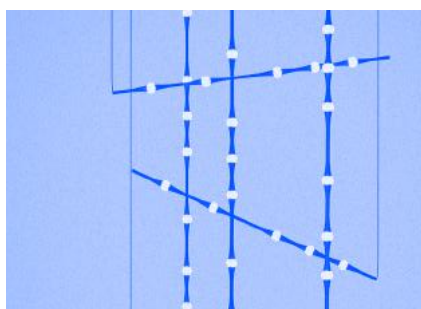

**Dew 156**



**Prolix 154**

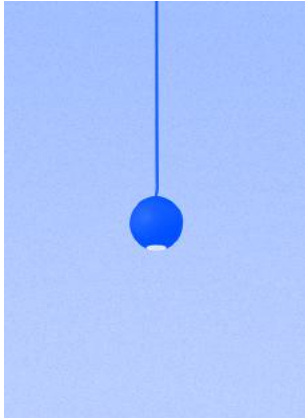

**Punto**

**162**



**Alive**

**159**

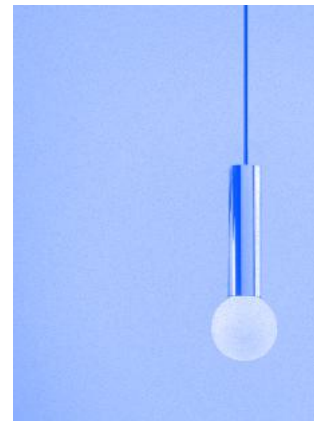

**Mist**

**164**



**Circ**

**165**



**Pipe**

**170**



Caprice

168



Stylus

172

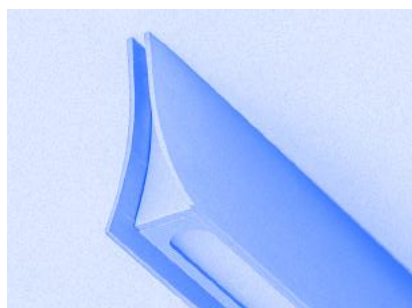

Bravo

174



Bol

177

# Voiles



Performance Universe



## Artesanal y contemporánea

Voiles es una pieza contemporánea realizada de forma artesanal siguiendo una técnica de elaboración milenaria con el papel japonés washi. La diseñadora Céline Wright se ha inspirado en sus travesías en barco, mientras contemplaba las velas que dirigen el viento en alta mar. Voiles cuenta con delicadas piezas superpuestas que crean dibujos y sombras gracias a esta técnica artesanal.

## Artesanal e contemporânea

Voiles é uma peça contemporânea realizada de forma artesanal utilizando uma técnica de elaboração milenar com o papel japonês washi. A designer Céline Wright inspirou-se nas suas viagens de barco enquanto contemplava as velas que dirigiam o vento no alto-mar. Voiles apresenta delicadas peças sobrepostas que criam padrões e sombras graças a esta técnica artesanal.



## Voiles Small Surface

BODY MAT	DIF MAT
ST	WASHI

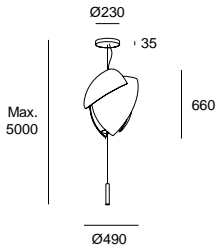

LED | CRI 92 | Real Lm 2357

Blanco Branco 14

Cromo Cromado 21

	K	W Total	Structure	Body	Code
1-10V 100-240V	2700	36	21 <input checked="" type="radio"/>	14 <input type="radio"/>	<b>00-7692-21-14</b>
PHASE CUT 220-240V	2700	37.8	21 <input checked="" type="radio"/>	14 <input type="radio"/>	<b>00-7691-21-14</b>
DALI 100-277V	2700	38.1	21 <input checked="" type="radio"/>	14 <input type="radio"/>	<b>00-7693-21-14</b>
1-10V 100-240V	3000	36	21 <input checked="" type="radio"/>	14 <input type="radio"/>	<b>00-6307-21-14</b>
PHASE CUT 220-240V	3000	37.8	21 <input checked="" type="radio"/>	14 <input type="radio"/>	<b>00-6306-21-14</b>
DALI 100-277V	3000	38.1	21 <input checked="" type="radio"/>	14 <input type="radio"/>	<b>00-6308-21-14</b>

## Voiles Small Recessed

BODY MAT	DIF MAT
ST	WASHI

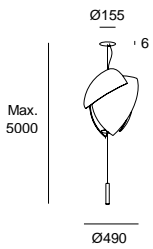

LED | CRI 92 | Real Lm 2357

Blanco Branco 14

Cromo Cromado 21

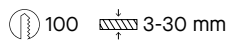

	K	W Total	Structure	Body	Code
1-10V 100-240V	2700	36	21 <input checked="" type="radio"/>	14 <input type="radio"/>	<b>00-7695-21-14</b>
PHASE CUT 220-240V	2700	37.8	21 <input checked="" type="radio"/>	14 <input type="radio"/>	<b>00-7694-21-14</b>
DALI 100-277V	2700	38.1	21 <input checked="" type="radio"/>	14 <input type="radio"/>	<b>00-7696-21-14</b>
1-10V 100-240V	3000	36	21 <input checked="" type="radio"/>	14 <input type="radio"/>	<b>00-6318-21-14</b>
PHASE CUT 220-240V	3000	37.8	21 <input checked="" type="radio"/>	14 <input type="radio"/>	<b>00-6317-21-14</b>
DALI 100-277V	3000	38.1	21 <input checked="" type="radio"/>	14 <input type="radio"/>	<b>00-6319-21-14</b>

## Voiles Big Surface

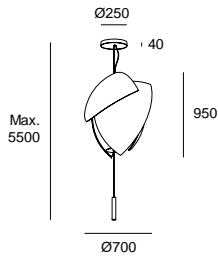
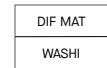

LED | CRI 92 | Real Lm 4032

Blanco Branco 14   
Cromo Cromado 21

	K	W Total	Structure	Body	Code
DALI 220-240V	2700	52.2	21 <input type="radio"/>	14 <input type="radio"/>	<b>00-7687-21-14</b>
1-10V 100-240V	2700	53.5	21 <input type="radio"/>	14 <input type="radio"/>	<b>00-7686-21-14</b>
PHASE CUT 220-240V	2700	56.6	21 <input type="radio"/>	14 <input type="radio"/>	<b>00-7685-21-14</b>
DALI 220-240V	3000	52.2	21 <input type="radio"/>	14 <input type="radio"/>	<b>00-6305-21-14</b>
1-10V 100-240V	3000	53.5	21 <input type="radio"/>	14 <input type="radio"/>	<b>00-6304-21-14</b>
PHASE CUT 220-240V	3000	56.6	21 <input type="radio"/>	14 <input type="radio"/>	<b>00-6303-21-14</b>

## Voiles Big Recessed

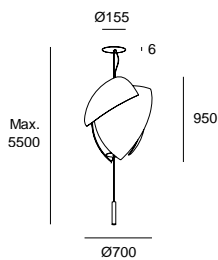
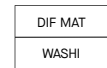

LED | CRI 92 | Real Lm 4032

Blanco Branco 14   
Cromo Cromado 21

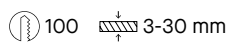

	K	W Total	Structure	Body	Code
DALI 220-240V	2700	52.2	21 <input type="radio"/>	14 <input type="radio"/>	<b>00-7690-21-14</b>
1-10V 100-240V	2700	53.5	21 <input type="radio"/>	14 <input type="radio"/>	<b>00-7689-21-14</b>
PHASE CUT 220-240V	2700	56.6	21 <input type="radio"/>	14 <input type="radio"/>	<b>00-7688-21-14</b>
DALI 220-240V	3000	52.2	21 <input type="radio"/>	14 <input type="radio"/>	<b>00-6316-21-14</b>
1-10V 100-240V	3000	53.5	21 <input type="radio"/>	14 <input type="radio"/>	<b>00-6315-21-14</b>
PHASE CUT 220-240V	3000	56.6	21 <input type="radio"/>	14 <input type="radio"/>	<b>00-6314-21-14</b>

## Voiles Pendant & Ceiling

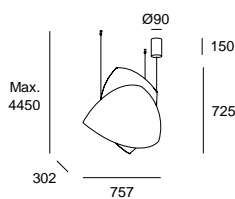
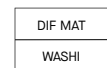

LED | K 2700 | CRI 92 | W Total 33.6 | Real Lm 1864

Blanco Branco 14   
Cromo Cromado 21

	Structure	Body	Code
0-10V / 1-10V / DALI2 110-240V	21 <input type="radio"/>	14 <input type="radio"/>	<b>15-7723-21-14</b>

# Levels



## Performance Universe



P. 212



P. 250



P. 328



### Una luz con gran carisma

Levels hace gala de un carácter camaleónico, en cualquiera de sus composiciones, no sólo por la finura de sus formas, sino también por la diversidad de sus temperaturas de color y su eficiencia lumínica. Con una amplia familia formada por versiones de colgante, plafón, sobremesa y pie de salón, presenta tres niveles de composición posibles con diferentes transparencias, que pueden utilizarse individualmente, de forma doble o triple creando nuevas adiciones de color y grados de transparencia.

### Uma luz com grande carisma

Levels faz gala de um caráter camaleônico, em qualquer uma das suas composições, não só pela delicadeza das suas formas, mas também pela diversidade das suas temperaturas de cor e a sua eficiência lumínica. Com uma ampla família formada por versões de suspensão, plafon, de mesa e candeeiro de pé, apresenta três níveis possíveis de composição com diferentes transparências que podem ser utilizados individualmente, de forma dupla ou tripla, criando novas adições de cor e graus de transparência.





El corazón de Levels reside en su difusor de vidrio soplado artesanalmente: una pieza única, con variaciones propias del proceso manual, cuya transparencia y textura convierten la luz en un gesto orgánico, elegante y casi escultórico.

O coração de Levels encontra-se no seu difusor de vidro soprado à mão: uma peça única, com variações próprias do processo manual, cuja transparência e textura transformam a luz num gesto orgânico, elegante e quase escultural.

Levels ofrece tres temperaturas de color —2700K, 3000K y 4000K— para adaptar la luz a cada ambiente.

Levels oferece três temperaturas de cor – 2700K, 3000K e 4000K – para adaptar a luz a cada ambiente.



2700K



3000K



4000K



Levels combina tres grados de transparencia, 30%, 50% y 70%.

Con tres acabados de vidrio, verde, fumé y ámbar, para modular la luz, el volumen y los matices cálidos que definen cada composición.

“Levels combina três graus de transparência, 30%, 50% e 70%.

Com três acabamentos em vidro, verde, fumé e âmbar, para modular a luz, o volume e as nuances quentes que definem cada composição.”



## Levels 1 Body Ø220mm

QS

BODY MAT
ST

DIF MAT
GLA



SWITCH CCT
2700-3000-4000

Negro Preto	05	●
Verde Verde	08	●
Fumé Fumado	12	●
Âmbar Âmbar	15	●

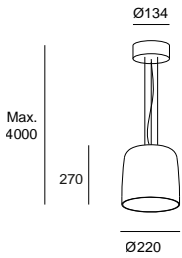

LED | K 2700-3000-4000 | CRI 92 | W Total 19 | Real Lm 1381 (3000K)

	Structure	Difussor	Code
PHASE CUT 220-240V	05 ●	08 ●	<b>00-A024-05-08</b>
	05 ●	12 ●	<b>00-A024-05-12</b>
	05 ●	15 ●	<b>00-A024-05-15</b>
DALI-2 110-277V	05 ●	08 ●	<b>00-A042-05-08</b>
	05 ●	12 ●	<b>00-A042-05-12</b>
	05 ●	15 ●	<b>00-A042-05-15</b>

## Levels 1 Body Ø320mm

QS

BODY MAT
ST

DIF MAT
GLA



SWITCH CCT
2700-3000-4000

Negro Preto	05	●
Verde Verde	08	●
Fumé Fumado	12	●
Âmbar Âmbar	15	●

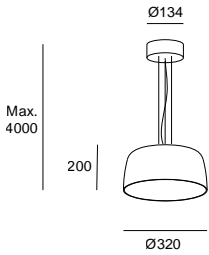

LED | K 2700-3000-4000 | CRI 92 | W Total 19 | Real Lm 1381 (3000K)

	Structure	Difussor	Code
PHASE CUT 220-240V	05 ●	08 ●	<b>00-A025-05-08</b>
	05 ●	12 ●	<b>00-A025-05-12</b>
	05 ●	15 ●	<b>00-A025-05-15</b>
DALI-2 110-277V	05 ●	08 ●	<b>00-A043-05-08</b>
	05 ●	12 ●	<b>00-A043-05-12</b>
	05 ●	15 ●	<b>00-A043-05-15</b>

## Levels 1 Body Ø420mm

QS

BODY MAT
ST

DIF MAT
GLA



SWITCH CCT
2700-3000-4000

Negro Preto	05	●
Verde Verde	08	●
Fumé Fumado	12	●
Âmbar Âmbar	15	●

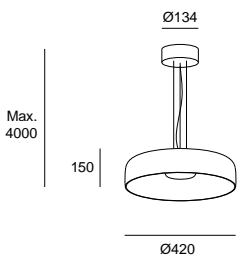

LED | K 2700-3000-4000 | CRI 92 | W Total 19 | Real Lm 1381 (3000K)

	Structure	Difussor	Code
PHASE CUT 220-240V	05 ●	08 ●	<b>00-A026-05-08</b>
	05 ●	12 ●	<b>00-A026-05-12</b>
	05 ●	15 ●	<b>00-A026-05-15</b>
DALI-2 110-277V	05 ●	08 ●	<b>00-A044-05-08</b>
	05 ●	12 ●	<b>00-A044-05-12</b>
	05 ●	15 ●	<b>00-A044-05-15</b>

\*Los acabados y tonalidad mostrados pueden no ser completamente precisos debido a ligeras variaciones en la producción, factores de iluminación, fotográficas e impresión.

\*Os acabamentos e tonalidades apresentados podem não ser totalmente precisos, devido a ligeiras variações na produção, fatores de iluminação fotográfica e de impressão.

## Levels 2 Bodies Ø320mm + Ø220mm

QS

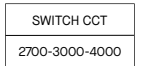
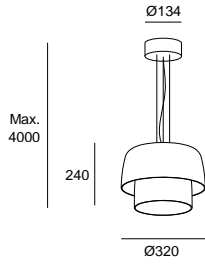

Negro Preto 05 ●  
 Verde Verde 08 ●  
 Fumé Fumado 12 ●  
 Âmbar Âmbar 15 ●

LED | K 2700-3000-4000 | CRI 92 | W Total 19 | Real Lm 1381 (3000K)

	Structure	Difussor	Code
PHASE CUT 220-240V	05 ●	08 ●	00-A027-05-08
	05 ●	12 ●	00-A027-05-12
	05 ●	15 ●	00-A027-05-15
DALI-2 110-277V	05 ●	08 ●	00-A045-05-08
	05 ●	12 ●	00-A045-05-12
	05 ●	15 ●	00-A045-05-15

## Levels 2 Bodies Ø420mm + Ø320mm

QS

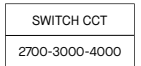
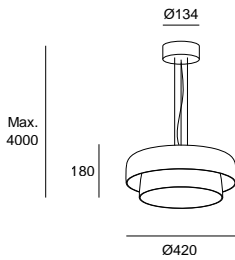

Negro Preto 05 ●  
 Verde Verde 08 ●  
 Fumé Fumado 12 ●  
 Âmbar Âmbar 15 ●

LED | K 2700-3000-4000 | CRI 92 | W Total 19 | Real Lm 1381 (3000K)

	Structure	Difussor	Code
PHASE CUT 220-240V	05 ●	08 ●	00-A028-05-08
	05 ●	12 ●	00-A028-05-12
	05 ●	15 ●	00-A028-05-15
DALI-2 110-277V	05 ●	08 ●	00-A046-05-08
	05 ●	12 ●	00-A046-05-12
	05 ●	15 ●	00-A046-05-15

## Levels 3 Bodies Ø420mm + Ø320mm + Ø220mm

QS

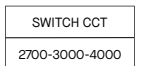
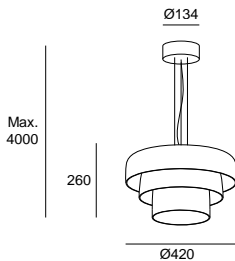

Negro Preto 05 ●  
 Verde Verde 08 ●  
 Fumé Fumado 12 ●  
 Âmbar Âmbar 15 ●

LED | K 2700-3000-4000 | CRI 92 | W Total 19 | Real Lm 1381 (3000K)

	Structure	Difussor	Code
PHASE CUT 220-240V	05 ●	08 ●	00-A041-05-08
	05 ●	12 ●	00-A041-05-12
	05 ●	15 ●	00-A041-05-15
DALI-2 110-277V	05 ●	08 ●	00-A047-05-08
	05 ●	12 ●	00-A047-05-12
	05 ●	15 ●	00-A047-05-15

# Ilargi



Performance Universe



P. 218



## Elegancia natural

Ilargi, creada por los diseñadores vascos Irtzoki y Lizaso, es una combinación perfecta de calidez y diseño funcional atemporal. Su cristal de vidrio soplado de manera artesanal permite regular una luz tamizada, que se combina con madera noble maciza. Su luz es suave y agradable, perfecta para uso residencial o para espacios públicos creando ambientes confortables y naturales.

## Elegância natural

Ilargi, criada pelos designers bascos Irtzoki e Lizaso, é uma combinação perfeita de calidez e design funcional intemporal. A sua campânula de vidro soprado de forma artesanal permite regular a luz filtrada, que combina com a madeira nobre maciça. A sua luz é suave e agradável, perfeita para uso residencial ou para espaços públicos criando ambientes confortáveis e naturais.

Acabados en madera maciza, natural y negro.  
Acabamentos em madeira maciça, natural e preto.



## Ilargi Ø240

BODY MAT  
ST.WOOD

DIF MAT  
GLA



Fresno oscuro Cinza escura 92 ●  
Fresno claro Cinza claro 93 ●  
Arenado Areado F9 ○

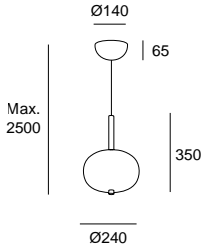

LED | K 2700 | CRI 92 | W Total 11.8 | Real Lm 641

	Structure	Difussor	Code
PHASE CUT 220-240V	92 ●	F9 ○	<b>00-6452-92-F9</b>
	93 ●	F9 ○	<b>00-6452-93-F9</b>
0-10V 120-277V	92 ●	F9 ○	<b>00-6010-92-F9</b>
	93 ●	F9 ○	<b>00-6010-93-F9</b>
DALI 220-240V	92 ●	F9 ○	<b>00-6454-92-F9</b>
	93 ●	F9 ○	<b>00-6454-93-F9</b>

Florón blanco  
Florão branco

## Ilargi Ø320

BODY MAT  
ST.WOOD

DIF MAT  
GLA



Fresno oscuro Cinza escura 92 ●  
Fresno claro Cinza claro 93 ●  
Arenado Areado F9 ○

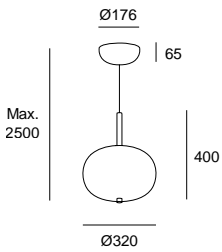

LED | K 2700 | CRI 92 | W Total 18.9 | Real Lm 1054

	Structure	Difussor	Code
PHASE CUT 220-240V	92 ●	F9 ○	<b>00-6455-92-F9</b>
	93 ●	F9 ○	<b>00-6455-93-F9</b>
1-10V 120-277V	92 ●	F9 ○	<b>00-6011-92-F9</b>
	93 ●	F9 ○	<b>00-6011-93-F9</b>
DALI 220-240V	92 ●	F9 ○	<b>00-6457-92-F9</b>
	93 ●	F9 ○	<b>00-6457-93-F9</b>

Florón blanco  
Florão branco

## Ilargi Ø395

BODY MAT  
ST.WOOD

DIF MAT  
GLA



Fresno oscuro Cinza escura 92 ●  
Fresno claro Cinza claro 93 ●  
Arenado Areado F9 ○

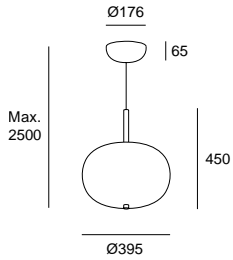

LED | K 2700 | CRI 92 | W Total 25.5 | Real Lm 1507

	Structure	Difussor	Code
PHASE CUT 220-240V	92 ●	F9 ○	<b>00-6458-92-F9</b>
	93 ●	F9 ○	<b>00-6458-93-F9</b>
1-10V 100-240V	92 ●	F9 ○	<b>00-6012-92-F9</b>
	93 ●	F9 ○	<b>00-6012-93-F9</b>
DALI/PUSH 220-240V	92 ●	F9 ○	<b>00-6460-92-F9</b>
	93 ●	F9 ○	<b>00-6460-93-F9</b>

Florón blanco  
Florão branco

## Ilargi 2 Bodies

BODY MAT  
ST.WOOD

DIF MAT  
GLA



Fresno oscuro Cinza escura 92 ●  
Fresno claro Cinza claro 93 ●  
Arenado Areado F9 ○

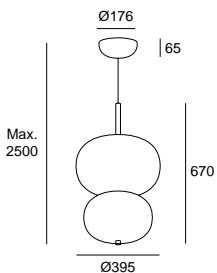

LED | K 2700 | CRI 92 | W Total 40.6 | Real Lm 1833

	Structure	Difussor	Code
PHASE CUT 220-240V	92 ●	F9 ○	<b>00-6461-92-F9</b>
	93 ●	F9 ○	<b>00-6461-93-F9</b>
1-10V 100-240V	92 ●	F9 ○	<b>00-6013-92-F9</b>
	93 ●	F9 ○	<b>00-6013-93-F9</b>
DALI 100-277V	92 ●	F9 ○	<b>00-6463-92-F9</b>
	93 ●	F9 ○	<b>00-6463-93-F9</b>

Florón blanco  
Florão branco

# Iris



## Performance Universe



Arquitectural y decorativa a la vez, Iris es una colección orgánica y viva, que dialoga activamente creando diferentes ambientes y mejorándolos con su presencia a través de la luz y la percepción visual de su estructura. Sus opciones de adaptación al espacio y composición son tan amplias que forman un círculo de creación en perfecta armonía.

Arquitetural e decorativa ao mesmo tempo, Iris é uma coleção orgânica e viva que dialoga ativamente, criando diferentes ambientes e valorizando-os com a sua presença através da luz e da percepção visual da sua estrutura. As suas opções de adaptação ao espaço e composição são tão amplas que formam um círculo de criação em perfeita harmonia.



Composición mediante configurador online  
Composição através de configurador online



Composición mediante configurador online  
Composição através de configurador online



Composición mediante configurador online  
Composição através de configurador online



Composición mediante configurador online  
Composição através de configurador online

\*Los acabados y tonalidad mostrados pueden no ser completamente precisos debido a ligeras variaciones en la producción, factores de iluminación, fotográficas e impresión.

\*Os acabamentos e tonalidades apresentados podem não ser totalmente precisos, devido a ligeiras variações na produção, fatores de iluminação fotográfica e de impressão.

# Configura tu Iris

## Configure a sua Iris



Configurador para personalización disponible.  
Configurador para personalização disponível.

[iris.ledsc4.com](http://iris.ledsc4.com)

AV14	-P6	V9	U	1	OS	60
Instalación Instalação	Potencia Potência	Temperatura de la luz Temperatura da luz	Pantalla Quebra-luz	Optics Ótica	Fuente de alimentación Fonte de alimentação	Acabados Acabamentos
AV14 AV15 AV16 AV26	P6 6.3 W 12 12.5 W 18 18.1 W	V9 2700K W9 3000K X9 4000K	U Hoop	1 15° 2 35° 3 50°	OS ON-OFF DS DALI-2	60 O2 L9 O8

### 1 Instalación Installation

AV16 Surface



AV26 IP23



AV14 Trim

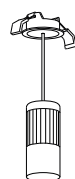

⌀ 57mm

AV15 Trimless

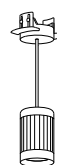

⌀ 57mm

### 2 Potencia Potência

P6 6.3 W    12 12.5 W    18 18.1 W

### 3 Temperatura de la luz Temperatura da luz

V9 2700K



W9 3000K



X9 4000K



### 4 Pantalla Quebra-luz

U Hoop



### 5 Optics Ótica

1 15°    2 35°    3 50°

### 6 Fuente de alimentación Fonte de alimentação

OU ON/OFF\*    DU DALI\*

### 7 Acabados Acabamentos

	60	L9	O2	O8	
Hoop					
Installation	●	●	○	●	○ White Branco ● Gray Cinza
Module	●	●	●	●	● Oro Ouro ● Negro Preto
Shade	●	●	●	●	

### Accesorios | Acessórios

71-5167-00-00  
Difusor elíptico (5u.)  
Difusor elíptico (5u.)



71-5658-00-00  
Difusor cuadrado (5u.)  
Difusor quadrado (5u.)



71-6099-00-00  
Difuminador de halo (5u.)  
Difusor opalino (5u.)



71-5166-60-00  
Panel de abeja (5u.)  
Painel de abelha (5u.)



71-7895-00-00  
Apantallador (5u.)  
Obturador assimétrico (5u.)



\*Para conocer el voltaje de operación de cada referencia, consulte su respectiva ficha técnica.

\*Para conhecer a voltagem de operação de cada referência, consulte sua respectiva ficha técnica.

# Plat



## Performance Universe



### Suave elegancia

Con una trabajada pero sencilla forma ovalada soplada en vidrio artesanalmente, Plat es una propuesta que destaca precisamente por la suavidad de su diseño. En tres tonalidades diferentes, puede instalarse de forma individual o en composición.

### Suavidade e elegância

Com uma trabalhada mas simples forma oval soprada de forma artesanal em vidro, Plat é uma proposta que se destaca precisamente pela suavidade do seu design. Em três tonalidades diferentes, pode ser instalada individualmente ou numa composição.



Tonalidad verde al 30%.  
Matiz verde a 30%.



Tonalidad fumé al 50%.  
Matiz fumé a 50%.



Tonalidad ámbar al 30%.  
Matiz ámbar a 30%.

## Plat Surface

QS

BODY MAT	DIF MAT		SWITCH CCT
ST	GLA		2700-3000-4000

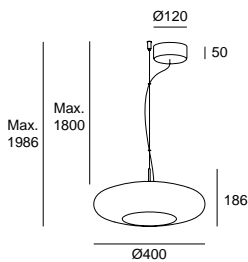

LED | K 2700-3000-4000 | CRI 92 | W Total 13 (3000K)

Negro Preto	05	
Verde Verde	08	
Fumé Fumado	12	
Ámbar Âmbar	15	

	Real Lm	Canopy	Body	Code
PHASE CUT 220-240V	805	05	08	<b>00-8403-05-08</b>
	762	05	12	<b>00-8403-05-12</b>
	743	05	15	<b>00-8403-05-15</b>

QS Quick Service | 2-6 días laborables (tiempo de transporte no incluido)  
Quick Service | 2-6 dias úteis (tempo de transporte não incluido)

## Plat Recessed

BODY MAT	DIF MAT		SWITCH CCT
ST	GLA		2700-3000-4000

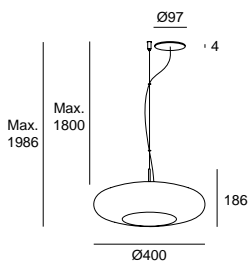

LED | K 2700-3000-4000 | CRI 92 | W Total 13 (3000K)

Negro Preto	05	
Verde Verde	08	
Fumé Fumado	12	
Ámbar Âmbar	15	

	Real Lm	Canopy	Body	Code
PHASE CUT 220-240V	805	05	08	<b>00-8405-05-08</b>
	762	05	12	<b>00-8405-05-12</b>
	743	05	15	<b>00-8405-05-15</b>
DALI-2 220-240V	805	05	08	<b>00-8406-05-08</b>
	762	05	12	<b>00-8406-05-12</b>
	743	05	15	<b>00-8406-05-15</b>

65 3-30 mm

\*Los acabados y tonalidad mostrados pueden no ser completamente precisos debido a ligeras variaciones en la producción, factores de iluminación, fotográficas e impresión.

\*Os acabamentos e tonalidades apresentados podem não ser totalmente precisos, devido a ligeiras variações na produção, fatores de iluminação fotográfica e de impressão.

# Khoi



Performance Universe





## Khoi Surface

QS

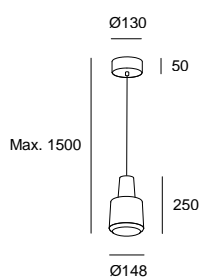

LED | K 3000 | CRI 80 | W Total 22.7 | Real Lm 907



ON-OFF 220-240V

Body Difussor Code

14  CS

37  12

BODY MAT	DIF MAT	
AL	GLA	

Blanco Branco	14	<input type="radio"/>
Gris cemento Cinzento cimento	CS	<input type="radio"/>
Transparente Transparente	37	<input type="radio"/>
Fumé Fumado	12	<input type="radio"/>

**00-A015-14-37**  
**00-A015-CS-12**

## Khoi Recessed

QS

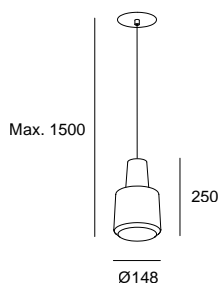

LED | K 3000 | CRI 80 | W Total 22.7 | Real Lm 907



ON-OFF 220-240V

Body Difussor Code

14  CS

37  12

BODY MAT	DIF MAT	
AL	GLA	

Blanco Branco	14	<input type="radio"/>
Gris cemento Cinzento cimento	CS	<input type="radio"/>
Transparente Transparente	37	<input type="radio"/>
Fumé Fumado	12	<input type="radio"/>

**00-A016-14-37**  
**00-A016-CS-12**

3-30 mm 65

\*Los acabados y tonalidad mostrados pueden no ser completamente precisos debido a ligeras variaciones en la producción, factores de iluminación, fotográficas e impresión.

\*Os acabamentos e tonalidades apresentados podem não ser totalmente precisos, devido a ligeiras variações na produção, fatores de iluminação fotográfica e de impressão.

# Glam



## Performance Universe



### Elegancia natural

Personalidad y elegancia son algunos de los atributos de Glam. Realizada en vidrio soplado, el resultado es una colección integradora que propicia un ambiente agradable, cálido y con carácter.

### Elegância natural

Personalidade e elegância são alguns dos atributos de Glam. Realizada em vidro soprado, o resultado é uma coleção integradora que cria um ambiente agradável, acolhedor e com caráter.

\*Los acabados y tonalidad mostrados pueden no ser completamente precisos debido a ligeras variaciones en la producción, factores de iluminación, fotográficas e impresión.

\*Os acabamentos e tonalidades apresentados podem não ser totalmente precisos, devido a ligeiras variações na produção, fatores de iluminação fotográfica e de impressão.

Disponibile en dos medidas.  
Disponível em duas medidas.

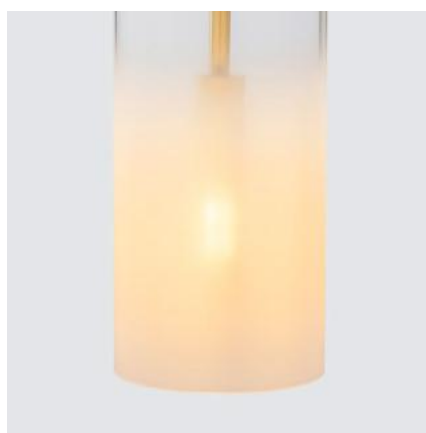
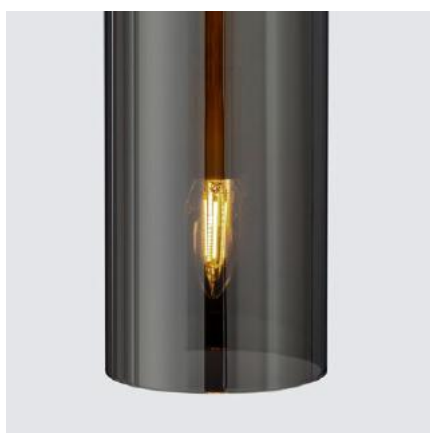

Vidrio soplado de forma artesanal.

Vidro soprado de forma artesanal.

### Glam 310mm

QS

BODY MAT	DIF MAT	
ST	GLA	

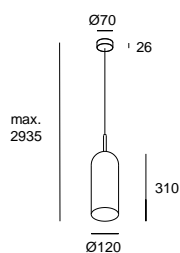

E14 | W Max. 9

- Blanco Branco 14
- Oro mate Ouro mate DN
- Fumé Fumado 12

Structure	Body	Code
DN	12	<b>00-8107-DN-12</b>
DN	14	<b>00-8107-DN-14</b>

### Glam 385mm

QS

BODY MAT	DIF MAT	
ST	GLA	

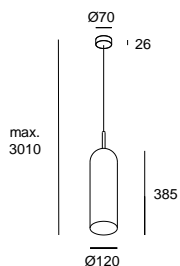

E14 | W Max. 9

- Blanco Branco 14
- Oro mate Ouro mate DN
- Fumé Fumado 12

Structure	Body	Code
DN	12	<b>00-8108-DN-12</b>
DN	14	<b>00-8108-DN-14</b>

# Gong



Performance Universe



P. 332



## Calidez y luz ambiental: pureza e innovación en el uso de materiales

Gong es una luminaria que sorprende, apropiándose de los espacios con una luz tamizada que se filtra de forma sugerente a través del tejido de su campana. Carisma y honestidad definen este diseño de Francesc Vilaró. Además de aportar una sensibilidad especial jugando con la vista y el tacto, el diseño de Gong está pensado para ofrecer un alto rendimiento lumínico en un cuerpo decorativo. Con tres acabados estándar y opciones personalizadas de tejido bajo pedido, Gong destaca por su carácter único, tanto si está encendida como apagada.

## Calor e luz ambiente: pureza e inovação na utilização dos materiais

Gong é uma luminária que surpreende, apropriando-se dos espaços com uma luz que é filtrada de forma sugestiva através do tecido da sua campânula. Carisma e honestidade definem este design Francesc Vilaró. Além de proporcionar uma sensibilidade especial jogando com a visão e o tato, o design de Gong destinase a oferecer um alto rendimento lumínico num corpo decorativo. Com três acabamentos standard e opções de tecido personalizadas sob pedido, Gong destaca-se pelo seu carácter único, quer esteja ligada ou desligada.





El alma de Gong reside en su tejido, un material artesanal y duradero, resistente a la abrasión e ignífugo.

A alma de Gong reside no seu tecido, um material artesanal, duradouro, resistente à abrasão e ignífugo.

Gong se presenta en tres acabados inspirados en la naturaleza —arena, terracota y carbón— con marco metálico a juego para una imagen homogénea y elegante. Además, ofrece tejido personalizado bajo pedido.

Gong está disponível em três acabamentos inspirados na natureza – areia, carvão e terracota – com uma estrutura metálica a condizer para uma imagem homogénea e elegante. Oferece também tecido personalizado mediante pedido.



Beige Arena  
Bege Areia



Terracota  
Terracota



Negro Carbón  
Preto Carvão

Posibilidad de modificar la temperatura de color mediante un switch CCT.

A temperatura da cor pode ser alterada através de um switch CCT.



2700K



3000K



4000K

Gong incorpora difusor opal y microprismático que garantiza un control lumínico y el máximo confort visual.

Gong incorpora um difusor opalino e microprismático que garante o controlo lumínico e o máximo conforto visual.

Opal  
OpalinoMicroprismático  
Microprismático



Gong incorpora dos nuevas medidas y ofrece ahora tres tamaños —Ø340, Ø600 y Ø1000 mm— disponibles en versión colgante o plafón.

Gong incorpora duas novas medidas e oferece agora três tamanhos – Ø340, Ø600 e Ø1000 mm – disponíveis nas versões de suspensão ou plafon.

## Gong Ø340 Microprisma

BODY MAT	DIF MAT
ST	PMMA



LED | CRI 92 | W Totals 15

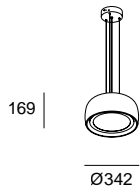

	K	Real Lm	Ring	Screen	Code
PHASE CUT 220-240V	2700	1019	FB	FA	<b>00-A350-FB-FA</b>
			W1	L1	<b>00-A350-W1-L1</b>
			60	EZ	<b>00-A350-60-EZ</b>
DALI-2 / PUSH 220-240V	2700	1019	FB	FA	<b>00-A351-FB-FA</b>
			W1	L1	<b>00-A351-W1-L1</b>
			60	EZ	<b>00-A351-60-EZ</b>
PHASE CUT 220-240V	3000	1061	FB	FA	<b>00-A352-FB-FA</b>
			W1	L1	<b>00-A352-W1-L1</b>
			60	EZ	<b>00-A352-60-EZ</b>
DALI-2 / PUSH 220-240V	3000	1061	FB	FA	<b>00-A353-FB-FA</b>
			W1	L1	<b>00-A353-W1-L1</b>
			60	EZ	<b>00-A353-60-EZ</b>
PHASE CUT 220-240V	4000	1089	FB	FA	<b>00-A354-FB-FA</b>
			W1	L1	<b>00-A354-W1-L1</b>
			60	EZ	<b>00-A354-60-EZ</b>
DALI-2 / PUSH 220-240V	4000	1089	FB	FA	<b>00-A355-FB-FA</b>
			W1	L1	<b>00-A355-W1-L1</b>
			60	EZ	<b>00-A355-60-EZ</b>

## Gong Ø340 Opal

BODY MAT	DIF MAT
ST	PMMA



LED | CRI 92 | W Totals 15

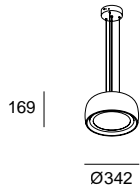

	K	Real Lm	Ring	Screen	Code
PHASE CUT 220-240V	2700	658	FB	FA	<b>00-A356-FB-FA</b>
			W1	L1	<b>00-A356-W1-L1</b>
			60	EZ	<b>00-A356-60-EZ</b>
DALI-2 / PUSH 220-240V	2700	658	FB	FA	<b>00-A357-FB-FA</b>
			W1	L1	<b>00-A357-W1-L1</b>
			60	EZ	<b>00-A357-60-EZ</b>
PHASE CUT 220-240V	3000	686	FB	FA	<b>00-A358-FB-FA</b>
			W1	L1	<b>00-A358-W1-L1</b>
			60	EZ	<b>00-A358-60-EZ</b>
DALI-2 / PUSH 220-240V	3000	686	FB	FA	<b>00-A359-FB-FA</b>
			W1	L1	<b>00-A359-W1-L1</b>
			60	EZ	<b>00-A359-60-EZ</b>
PHASE CUT 220-240V	4000	704	FB	FA	<b>00-A360-FB-FA</b>
			W1	L1	<b>00-A360-W1-L1</b>
			60	EZ	<b>00-A360-60-EZ</b>
DALI-2 / PUSH 220-240V	4000	704	FB	FA	<b>00-A361-FB-FA</b>
			W1	L1	<b>00-A361-W1-L1</b>
			60	EZ	<b>00-A361-60-EZ</b>

Los acabados y tonalidad mostrados pueden no ser completamente precisos debido a ligeras variaciones en la producción, factores de iluminación fotográficas e impresión.

Os acabamentos e tonalidades apresentados podem não ser totalmente precisos, devido a ligeiras variações na produção, fatores de iluminação fotográfica e de impressão.

Gris Seda Cinzento Seda	FB
Tejido Crema Tecido Creme	FA
Marrón Caoba Castanho Caoba	W1
Terracota jaspeado Terracota jaspeado	L1
Negro Preto	60
Tejido Negro Tecido Preto	EZ

## Gong Ø600 Microprisma

BODY MAT  
ST

DIF MAT  
PMMA



LED | CRI 92

231

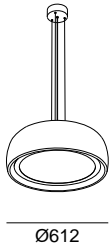

	K	W Total / Real Lm	Ring	Screen	Code
PHASE CUT 220-240V	2700	27.4W / 1688lm	FB	FA	<b>00-8902-FB-FA</b>
			W1	L1	<b>00-8902-W1-L1</b>
			60	EZ	<b>00-8902-60-EZ</b>
DALI-2 / PUSH 220-240V	2700	28W / 2074lm	FB	FA	<b>00-A366-FB-FA</b>
			W1	L1	<b>00-A366-W1-L1</b>
			60	EZ	<b>00-A366-60-EZ</b>
PHASE CUT 220-240V	3000	27.4W / 1688lm	FB	FA	<b>00-8933-FB-FA</b>
			W1	L1	<b>00-8933-W1-L1</b>
			60	EZ	<b>00-8933-60-EZ</b>
DALI-2 / PUSH 220-240V	3000	28W / 2150lm	FB	FA	<b>00-A367-FB-FA</b>
			W1	L1	<b>00-A367-W1-L1</b>
			60	EZ	<b>00-A367-60-EZ</b>
PHASE CUT 220-240V	4000	27.4W / 1688lm	FB	FA	<b>00-8953-FB-FA</b>
			W1	L1	<b>00-8953-W1-L1</b>
			60	EZ	<b>00-8953-60-EZ</b>
DALI-2 / PUSH 220-240V	4000	28W / 2202lm	FB	FA	<b>00-A368-FB-FA</b>
			W1	L1	<b>00-A368-W1-L1</b>
			60	EZ	<b>00-A368-60-EZ</b>

## Gong Ø600 Opal

BODY MAT  
ST

DIF MAT  
PMMA



LED | CRI 92

231

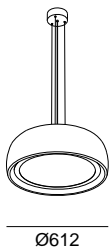

	K	W Total / Real Lm	Ring	Screen	Code
PHASE CUT 220-240V	2700	27.4W / 1275lm	FB	FA	<b>00-A294-FB-FA</b>
			W1	L1	<b>00-A294-W1-L1</b>
			60	EZ	<b>00-A294-60-EZ</b>
DALI-2 / PUSH 220-240V	2700	28W / 1572lm	FB	FA	<b>00-A369-FB-FA</b>
			W1	L1	<b>00-A369-W1-L1</b>
			60	EZ	<b>00-A369-60-EZ</b>
PHASE CUT 220-240V	3000	27.4W / 1275lm	FB	FA	<b>00-A295-FB-FA</b>
			W1	L1	<b>00-A295-W1-L1</b>
			60	EZ	<b>00-A295-60-EZ</b>
DALI-2 / PUSH 220-240V	3000	28W / 1624lm	FB	FA	<b>00-A370-FB-FA</b>
			W1	L1	<b>00-A370-W1-L1</b>
			60	EZ	<b>00-A370-60-EZ</b>
PHASE CUT 220-240V	4000	27.4W / 1275lm	FB	FA	<b>00-A296-FB-FA</b>
			W1	L1	<b>00-A296-W1-L1</b>
			60	EZ	<b>00-A296-60-EZ</b>
DALI-2 / PUSH 220-240V	4000	28W / 1669lm	FB	FA	<b>00-A371-FB-FA</b>
			W1	L1	<b>00-A371-W1-L1</b>
			60	EZ	<b>00-A371-60-EZ</b>

Los acabados y tonalidad mostrados pueden no ser completamente precisos debido a ligeras variaciones en la producción, factores de iluminación fotográficas e impresión.

Os acabamentos e tonalidades apresentados podem não ser totalmente precisos, devido a ligeiras variações na produção, fatores de iluminação fotográfica e de impressão.

Gris Seda Cinzento Seda FB

Tejido Crema Tecido Creme FA

Marrón Caoba Castanho Caoba W1

Terracota jaspeado Terracota jaspeado L1

Negro Preto 60

Tejido Negro Tecido Preto EZ

## Gong Ø1000 Microprisma

BODY MAT	DIF MAT
ST	PMMA

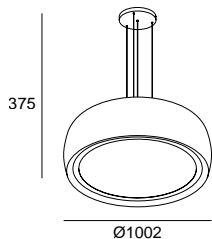

LED | CRI 92 | W Total 38.7

	K	Real Lm	Ring	Screen	Code
 PHASE CUT 220-240V	2700	3093	FB	FA	<b>00-A338-FB-FA</b> <b>QS</b> <b>00-A338-W1-L1</b> <b>QS</b> <b>00-A338-60-EZ</b> <b>QS</b>
			W1	L1	
			60	EZ	
DALI-2 / PUSH 220-240V	2700	3093	FB	FA	<b>00-A339-FB-FA</b> <b>00-A339-W1-L1</b> <b>00-A339-60-EZ</b>
			W1	L1	
			60	EZ	
PHASE CUT 220-240V	3000	3161	FB	FA	<b>00-A340-FB-FA</b> <b>QS</b> <b>00-A340-W1-L1</b> <b>QS</b> <b>00-A340-60-EZ</b> <b>QS</b>
			W1	L1	
			60	EZ	
DALI-2 / PUSH 220-240V	3000	3161	FB	FA	<b>00-A341-FB-FA</b> <b>00-A341-W1-L1</b> <b>00-A341-60-EZ</b>
			W1	L1	
			60	EZ	
PHASE CUT 220-240V	4000	3237	FB	FA	<b>00-A342-FB-FA</b> <b>QS</b> <b>00-A342-W1-L1</b> <b>QS</b> <b>00-A342-60-EZ</b> <b>QS</b>
			W1	L1	
			60	EZ	
DALI-2 / PUSH 220-240V	4000	3237	FB	FA	<b>00-A343-FB-FA</b> <b>00-A343-W1-L1</b> <b>00-A343-60-EZ</b>
			W1	L1	
			60	EZ	

## Gong Ø1000 Opal

BODY MAT	DIF MAT
ST	PMMA

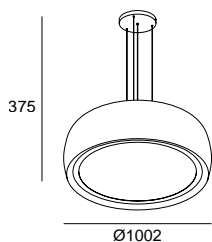

LED | CRI 92 | W Total 38.7

	K	Real Lm	Ring	Screen	Code
 PHASE CUT 220-240V	2700	2341	FB	FA	<b>00-A344-FB-FA</b> <b>QS</b> <b>00-A344-W1-L1</b> <b>QS</b> <b>00-A344-60-EZ</b> <b>QS</b>
			W1	L1	
			60	EZ	
DALI-2 / PUSH 220-240V	2700	2341	FB	FA	<b>00-A345-FB-FA</b> <b>00-A345-W1-L1</b> <b>00-A345-60-EZ</b>
			W1	L1	
			60	EZ	
PHASE CUT 220-240V	3000	2394	FB	FA	<b>00-A346-FB-FA</b> <b>QS</b> <b>00-A346-W1-L1</b> <b>QS</b> <b>00-A346-60-EZ</b> <b>QS</b>
			W1	L1	
			60	EZ	
DALI-2 / PUSH 220-240V	3000	2394	FB	FA	<b>00-A347-FB-FA</b> <b>00-A347-W1-L1</b> <b>00-A347-60-EZ</b>
			W1	L1	
			60	EZ	
PHASE CUT 220-240V	4000	2454	FB	FA	<b>00-A348-FB-FA</b> <b>QS</b> <b>00-A348-W1-L1</b> <b>QS</b> <b>00-A348-60-EZ</b> <b>QS</b>
			W1	L1	
			60	EZ	
DALI-2 / PUSH 220-240V	4000	2454	FB	FA	<b>00-A349-FB-FA</b> <b>00-A349-W1-L1</b> <b>00-A349-60-EZ</b>
			W1	L1	
			60	EZ	

Los acabados y tonalidad mostrados pueden no ser completamente precisos debido a ligeras variaciones en la producción, factores de iluminación fotográficas e impresión.

Os acabamentos e tonalidades apresentados podem não ser totalmente precisos, devido a ligeiras variações na produção, fatores de iluminação fotográfica e de impressão.

Gris Seda	Cinzeno Seda	FB		
Tejido Crema	Tecido Creme	FA		
Marrón Caoba	Castanho Caoba	W1		
Terracota jaspeado	Terracota jaspeado	L1		
	Negro Preto	60		
	Tejido Negro	Tecido Preto	EZ	

# COCO



Performance Universe



## La luminaria más grácil

Las esferas de luz difusa de Coco descansan en estructuras metálicas que crean una agradable combinación y proporcionan una luz ambiental adecuada para crear escenas relajantes.

## A luminária mais grácil

As esferas de luz difusa de Coco assentam em estruturas metálicas que criam uma combinação agradável e proporcionam uma luz ambiente adequada para criar cenas relaxantes.





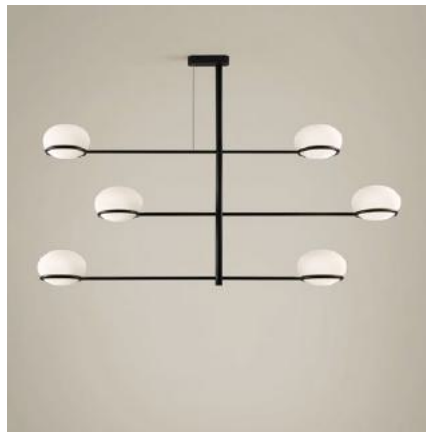

El chandelier permite elegir la posición de los brazos.

O chandelier permite escolher a posição dos braços.

### Coco Single

QS

BODY MAT	DIF MAT
ST,AL	PC

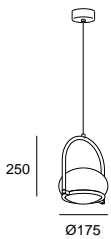

E14 | W Max. 9

Negro Preto 05 ●  
Oro pintado Ouro pintado ET ●  
Blanco opal Branco opalino M1 ○

Structure Difussor

Code

05 ● M1 ○  
ET ● M1 ○

00-7984-05-M1  
00-7984-ET-M1

### Coco Double

QS

BODY MAT	DIF MAT
ST,AL	PC

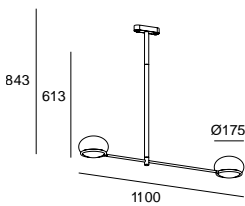

E14 | W 2 × Max. 9

Negro Preto 05 ●  
Blanco opal Branco opalino M1 ○

Structure Difussor

Code

05 ● M1 ○

00-9003-05-M1

### Coco Chandelier

QS

BODY MAT	DIF MAT
ST,AL	PC

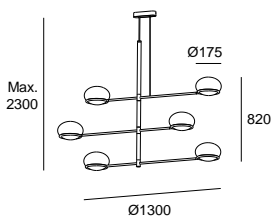

E14 | W 6 × Max. 9

Negro Preto 05 ●  
Blanco opal Branco opalino M1 ○

Structure Difussor

Code

05 ● M1 ○

00-7986-05-M1

# Shoemaker



Performance Universe



## Silenciosa calidez

Joel Karlsson reinterpreta con Shoemaker una forma clásica, dibujando con líneas rectas y puras una pieza muy técnica a la vez que decorativa. El acabado en fieltro reciclado del difusor en las dos opciones disponibles, es un factor determinante en la personalidad de la colección, que se presenta además con distintas temperaturas de color y otras ventajas de la iluminación inteligente.

## Silenciosa calidez

Joel Karlsson reinterpreta com Shoemaker uma forma clássica, criando com linhas retas e puras uma peça bastante técnica mas também decorativa. O acabamento em feltro reciclado do difusor nas duas opções disponíveis é um fator determinante na personalidade da coleção, que se apresenta também com diferentes temperaturas de cor e outras vantagens da iluminação inteligente.





### **Tecnología Tunable White (2700K – 6000K)**

Shoemaker integra tecnología Tunable White, que permite ajustar la temperatura de color entre 2700K y 6000K, adaptando la luz al ritmo biológico, al momento del día o al tipo de actividad. Desde tonos cálidos y acogedores hasta blancos fríos y energizantes, ofrece flexibilidad y bienestar en entornos profesionales, comerciales o residenciales.

### **Tecnologia Tunable White (2700 K - 6000 K)**

Shoemaker integra tecnologia Tunable White, que permite ajustar a temperatura da cor entre 2700 K e 6000 K, adaptando a luz ao ritmo biológico, à hora do dia ou ao tipo de atividade. Dos tons quentes e acolhedores aos brancos frios e energizantes, oferece flexibilidade e bem-estar em ambientes profissionais, comerciais ou residenciais.

## Shoemaker Ø669

BODY MAT	DIF MAT
ST,FELT	PMMA

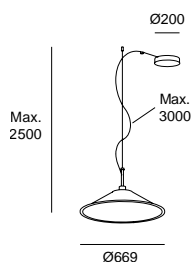

## LED | CRI 92

	K	W Total	Real Lm	Structure	Body	Code
0-10V 100-240V	2700	28.6	1494	05 ●	EK ●	<b>00-7728-05-EK</b>
				05 ●	EQ ●	<b>00-7728-05-EQ</b>
DALI-2 100-240V	2700	28.6	1494	05 ●	EK ●	<b>00-7731-05-EK</b>
				05 ●	EQ ●	<b>00-7731-05-EQ</b>
DALI DT8 220-240V (TW)	TW 2700-6500	22.2	1197	05 ●	EK ●	<b>00-7727-05-EK</b>
				05 ●	EQ ●	<b>00-7727-05-EQ</b>

Negro Preto 05 ●  
 Gris oscuro Cinza escuro EK ●  
 Gris antracita Cinza antracito EQ ●

## Shoemaker 1204mm

BODY MAT	DIF MAT
ST,FELT	PMMA

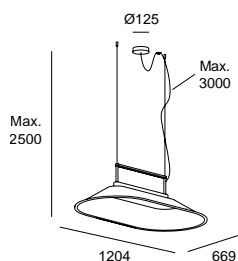

## LED | CRI 92

	K	W Total	Real Lm	Structure	Body	Code
0-10V 100-240V	2700	55	3631	05 ●	EK ●	<b>00-7730-05-EK</b>
				05 ●	EQ ●	<b>00-7730-05-EQ</b>
DALI-2 100-240V	2700	55	3631	05 ●	EK ●	<b>00-7732-05-EK</b>
				05 ●	EQ ●	<b>00-7732-05-EQ</b>
DALI DT8 220-240V (TW)	TW 2700-6500	53.9	4002	05 ●	EK ●	<b>00-7729-05-EK</b>
				05 ●	EQ ●	<b>00-7729-05-EQ</b>

Negro Preto 05 ●  
 Gris oscuro Cinza escuro EK ●  
 Gris antracita Cinza antracito EQ ●

80 0-20 mm

## Material técnico y sostenible

El panel está fabricado con material reciclado, fonoabsorbente y con propiedades ignífugas, lo que lo convierte en una solución ideal para espacios donde el confort acústico y la seguridad son prioritarios.

## Material técnico e sustentável

O painel é fabricado em material reciclado, fonoabsorvente e com propriedades ignífugas, o que o torna uma solução ideal para espaços onde o conforto acústico e a segurança são uma prioridade.



Acabado gris oscuro (EK)  
Acabamento cinzento-escuro (EK).



Acabado gris antracita (EQ)  
Acabamento cinzento antracite (EQ).

# Veneto



Performance Universe



P. 298



## Delicadeza atemporal

Veneto es una luminaria con un diseño clásico actual. Tanto la ligereza del difusor de metacrilato como el detalle en dorado de la pieza, le confieren una personalidad propia equilibrando su puesta en escena. Veneto ofrece una iluminación difusa y delicada, cálida e íntima, tanto en su versión individual como múltiple.

## Delicadeza intemporal

Veneto é uma luminária com um design clássico atual. Tanto a leveza do difusor de metacrilato como o detalhe dourado da peça conferem a esta uma personalidade própria, equilibrando a sua encenação. Veneto oferece uma iluminação difusa e delicada, quente e íntima, tanto na sua versão individual como múltipla.

Difusor de metacrilato.  
Difusor de metraquilato.



### Veneto Surfaced 1 Body

BODY MAT	DIF MAT	
ST.AL	PMMA	

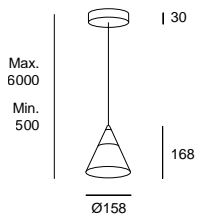

LED | K 2700 | CRI 80 | W Total 8.3 | Real Lm 452

Blanco Branco 14   
Latón pulido Latão polido DO

	Canopy	Body	Code
ON-OFF 220-240V	14 <input type="radio"/>	DO <input checked="" type="radio"/>	<b>00-A019-14-DO</b> <b>QS</b>
PHASE CUT 220-240V	14 <input type="radio"/>	DO <input checked="" type="radio"/>	<b>00-7589-14-DO</b>

Acabados The Colours bajo pedido mínimo de 15 unidades. Consultar precios en tarifa y plazos de entrega con equipo comercial.  
Acabamentos The Colours sujeitos a encomenda mínima de 15 unidades. Consultar preços e prazos de entrega com a nossa equipa comercial.

**Canopy:**  DL Oro Ouro **Body:**  DO Latón pulido Latão polido  
 60 Negro Preto  DO Latón pulido Latão polido

**QS** Quick Service | 2-6 días laborables (tiempo de transporte no incluido)  
Quick Service | 2-6 dias úteis (tempo de transporte não incluido)

### Veneto Recessed 1 Body

BODY MAT	DIF MAT	
ST.AL	PMMA	

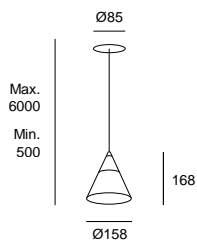

LED | K 2700 | CRI 80 | W Total 8.3 | Real Lm 452

Blanco Branco 14   
Latón pulido Latão polido DO

	Canopy	Body	Code
ON-OFF 220-240V	14 <input type="radio"/>	DO <input checked="" type="radio"/>	<b>00-A020-14-DO</b>
PHASE CUT 220-240V	14 <input type="radio"/>	DO <input checked="" type="radio"/>	<b>00-7591-14-DO</b>

65 0-30 mm

# Nimes



## Performance Universe



### Un clásico atemporal

Un clásico que nunca falla. Nimes es un óvalo opal sencillo y funcional.

### Um clássico intemporal

Um clássico que nunca falha. Nimes é um óvalo opal simples e funcional.

## Nimes

QS

BODY MAT	DIF MAT	
ST	GLA	

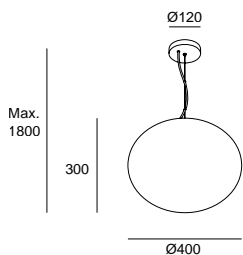

E27 | W Max. 15

Canopy      Difusor

14       F9

\*Bombilla no incluida.  
\*Lâmpada não incluida.

Blanco Branco 14   
Arenado Areado F9

Code

**00-9032-14-F9**



# Noway



## Performance Universe



P. 256



### Simplicidad y pureza

Noway combina a partes iguales simplicidad, pureza y autenticidad. La combinación de dos estructuras difusoras de distintos tamaños, en acabados negro mate y dorado, ofrecen una iluminación cálida y comfortable.

### Simplicidade e pureza

Noway combina simplicidade, pureza e autenticidade em partes iguais. A combinação de duas estruturas difusoras de tamanhos diferentes, em acabamentos preto mate e dourado, oferecem uma iluminação quente e confortável.

Cuenta con un switch para elegir la temperatura adecuada.  
Possui um switch para escolher a temperatura adequada.



La pantalla del nivel inferior siempre es en acabado negro.  
O quebra-luz do nível inferior sempre em acabamento preto.

## Noway Small

QS

BODY MAT	SWITCH CCT
ST	2700-3000-4000

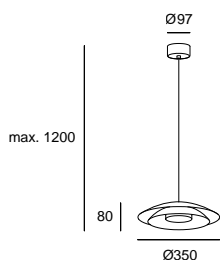

LED | K 2700-3000-4000 | CRI 92 | W Total 18.5 | Real Lm 618 (3000K)

Negro Preto 05 ●  
Oro mate Ouro mate DN ●



Upper Screen Lower Screen Code

PHASE CUT 220-240V

05 ●  
DN ●

05 ●  
05 ●

00-8392-05-05

00-8392-DN-05

## Noway Big

QS

BODY MAT	SWITCH CCT
ST	2700-3000-4000

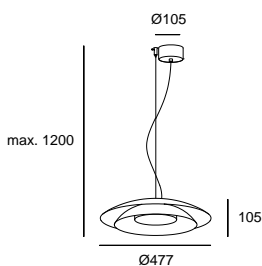

LED | K 2700-3000-4000 | CRI 92 | W Total 24.5 | Real Lm 813 (3000K)

Negro Preto 05 ●  
Oro mate Ouro mate DN ●



Upper Screen Lower Screen Code

PHASE CUT 220-240V

05 ●  
DN ●

05 ●  
05 ●

00-8395-05-05

00-8395-DN-05

Florón negro  
Florão preta

# Keops



## Essential Universe

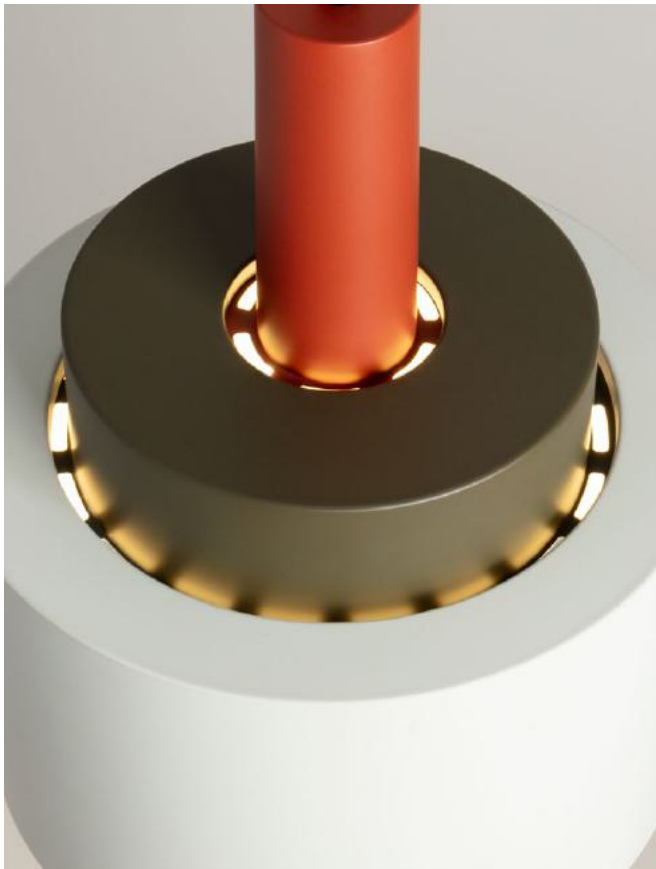

### Personalización y carácter

Keops es una colección de colgantes muy funcionales que usan bombilla. Este diseño tiene la clara intención de jugar con el color y sus diferentes medidas. Tiene unas geometrías sencillas y versátiles, donde destacan pequeños detalles como sus ranuras superiores que crean un juego de luz y sobras muy característico de este diseño. Además, es una luminaria que permite jugar de manera amplísima con el color de cada nivel ya que se puede personalizar cada uno con el RAL deseado.

### Personalização e caráter

Keops é uma coleção de suspensos muito funcionais que utilizam lâmpada. Este design tem a clara intenção de brincar com a cor e as suas diferentes medidas. Apresenta geometrias simples e versáteis, onde se destacam pequenos pormenores como as suas ranhuras superiores que criam um jogo de luz e sombra muito característico deste design. Para além disso, é uma luminária que permite combinar de forma ampla com a cor de cada nível, uma vez que cada um pode ser personalizado com o RAL desejado.

## Configura tu Keops Configure a sua Keops

Configurador para personalización disponible.  
Configurador para personalização disponível.

[keops.ledsc4.com](https://keops.ledsc4.com)



Acabados personalizables bajo petición mediante configurador.  
Acabamentos personalizáveis sob pedido através do configurador.



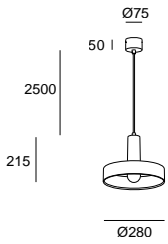
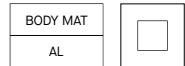

## Keops Individual

QS



E27 | W Max. 15

Blanco grisáceo Branco cinzento A1   
 Gris parduzco Castanho acinzentado A3   
 Rojo ladrillo Tijolo vermelho A4 

Canopy	Level 1	Level 2	Code
A1 	A1 	A1 	<b>00-9033-A1-A1</b>
A3 	A3 	A3 	<b>00-9033-A3-A1</b>
A4 	A4 	A4 	<b>00-9033-A4-A1</b>



\*Bombilla no incluida.  
 \*Lâmpada não incluida.

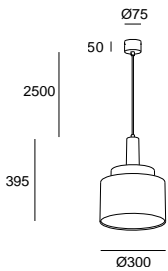
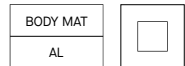

## Keops Triple Ø300

QS



E27 | W Max. 15

Blanco grisáceo Branco cinzento A1   
 Gris parduzco Castanho acinzentado A3   
 Rojo ladrillo Tijolo vermelho A4 

Canopy	Level 1	Level 2	Level 3	Code
A4 	A4 	A3 	A1 	<b>00-9035-CV-A1</b>



\*Bombilla no incluida.  
 \*Lâmpada não incluida.

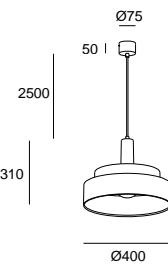
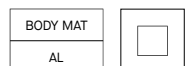

## Keops Triple Ø400

QS



E27 Globe Max. Ø120 mm | W Max. 15

Blanco grisáceo Branco cinzento A1   
 Gris parduzco Castanho acinzentado A3   
 Rojo ladrillo Tijolo vermelho A4 

Canopy	Level 1	Level 2	Level 3	Code
A3 	A3 	A1 	A4 	<b>00-9034-CV-A1</b>



\*Bombilla no incluida.  
 \*Lâmpada não incluida.

## Keops Triple Ø500

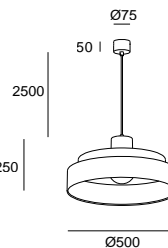
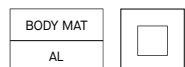
QS



E27 | W Max. 15

Blanco grisáceo Branco cinzento A1   
 Gris parduzco Castanho acinzentado A3   
 Rojo ladrillo Tijolo vermelho A4 

Canopy	Level 1	Level 2	Level 3	Code
A1 	A1 	A4 	A3 	<b>00-9036-CV-A1</b>

\*Bombilla no incluida.  
 \*Lâmpada não incluida.

# Attic



Performance Universe



P. 300



## Riqueza compositiva

Attic es un sistema de iluminación extremadamente funcional gracias a la gran facilidad de instalación y adición de luminarias. La luz de sus bombillas puede plantearse tanto para zonas de trabajo como para crear ambientes relajados. Además, el efecto lumínico que generan las aperturas laterales de la pantalla proporciona una integración total de la estructura del cableado en la composición final de la pieza. Con posibilidad de personalización del color de las pantallas y tres formas geométricas combinables entre ellas, Attic es una pieza modular en todos los sentidos.

## Riqueza compositiva

O Attic é um sistema de iluminação extremamente funcional graças à grande facilidade de instalação e de adição de luminárias. A luz das suas lâmpadas pode ser utilizada tanto para zonas de trabalho como para criar ambientes descontraídos. Além disso, o efeito lumínico gerado pelas aberturas laterais do abajur permite uma integração total da estrutura de cablagem na composição final da peça. Com a possibilidade de personalizar a cor dos abajures e três formas geométricas combináveis entre si, Attic é uma peça modular em todos os sentidos.



# Configura tu Attic

## Configure a sua Attic

Configurador para personalización disponible.  
Configurador para personalização disponível.

[attic.ledsc4.com](http://attic.ledsc4.com)



### 1 Instalación

#### Installation

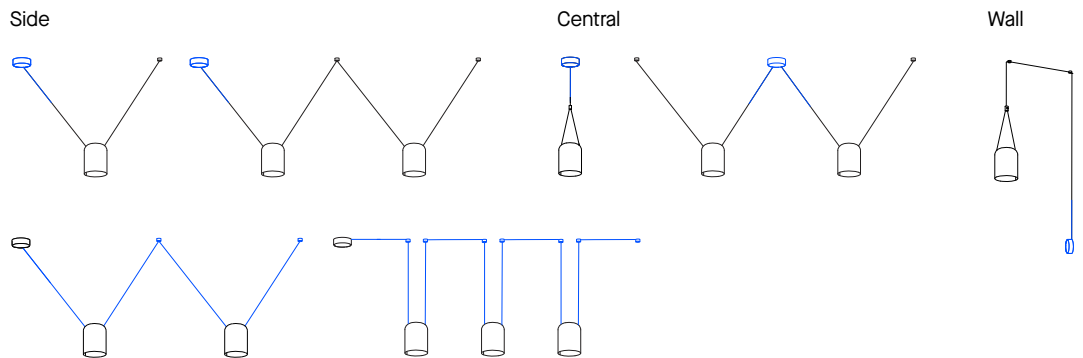

Con 2 opciones de instalación  
Con 2 opções de instalação

No hay opciones de instalación para el modelo individual con florón central.  
Não disponível para o modelo individual com roseta central.

### 2 Longitud de cable

#### Comprimento do cabo

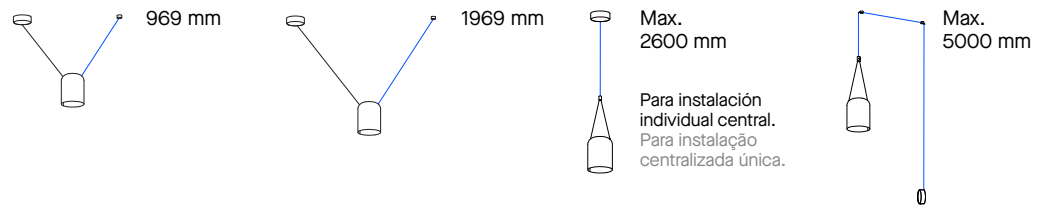

### 3 Pantalla

#### Quebra-luz



### 4 Combinaciones estandar

#### Combinações standard

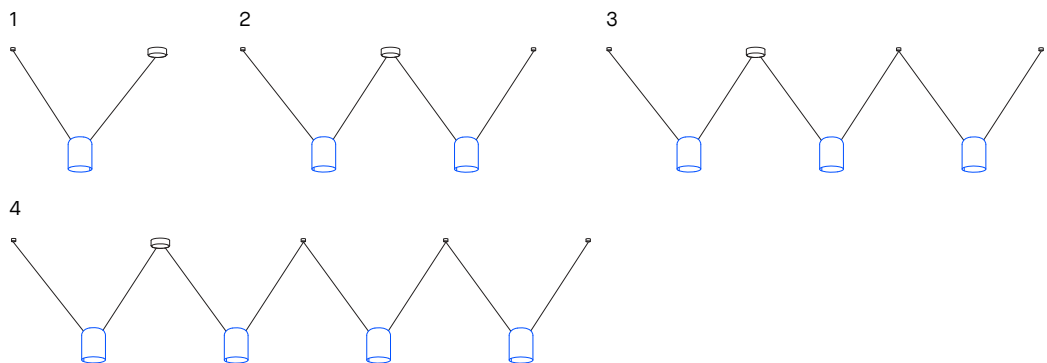

Más opciones a través del configurador.  
Mais opções através do configurador.

### 5 Acabados

#### Acabamentos



Múltiples colores personalizables bajo petición.  
Várias cores personalizáveis a pedido.



Los enganches al techo permiten las dos opciones de instalación.

Os suportes do teto permitem as duas opções de instalação.



## Attic Rectangular Shape

QS

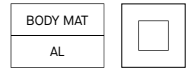

E27 | W Max. 15

 Blanco Branco 14   
 Negro Preto 05 

Structure	Exterior Screen	Code
05 <input checked="" type="radio"/> 05 <input checked="" type="radio"/>	05 <input checked="" type="radio"/> 14 <input type="radio"/>	<b>00-7388-05-05</b> <b>00-7388-05-14</b>
05 <input checked="" type="radio"/> 05 <input checked="" type="radio"/>	05 <input checked="" type="radio"/> 14 <input type="radio"/>	<b>00-7389-05-05</b> <b>00-7389-05-14</b>
05 <input checked="" type="radio"/> 05 <input checked="" type="radio"/>	05 <input checked="" type="radio"/> 14 <input type="radio"/>	<b>00-9007-05-05</b> <b>00-9007-05-14</b>

 \*Bombilla no incluida.  
 \*Lâmpada não incluida.
Attic Rectangular Shape V  
1200 mm

QS

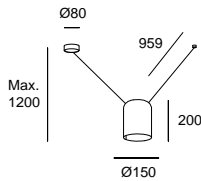
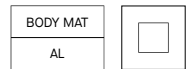

E27 | W Max. 15

 Blanco Branco 14   
 Negro Preto 05 

Structure	Exterior Screen	Code
05 <input checked="" type="radio"/> 05 <input checked="" type="radio"/>	05 <input checked="" type="radio"/> 14 <input type="radio"/>	<b>00-7392-05-05</b> <b>00-7392-05-14</b>
05 <input checked="" type="radio"/> 05 <input checked="" type="radio"/>	05 <input checked="" type="radio"/> 14 <input type="radio"/>	<b>00-7393-05-05</b> <b>00-7393-05-14</b>
05 <input checked="" type="radio"/> 05 <input checked="" type="radio"/>	05 <input checked="" type="radio"/> 14 <input type="radio"/>	<b>00-9042-05-05</b> <b>00-9042-05-14</b>

 \*Bombilla no incluida.  
 \*Lâmpada não incluida.
Attic Rectangular Shape V  
2200 mm

QS

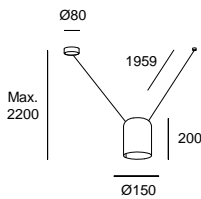
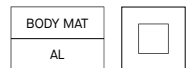

E27 | W Max. 15

 Blanco Branco 14   
 Negro Preto 05 

Structure	Exterior Screen	Code
05 <input checked="" type="radio"/> 05 <input checked="" type="radio"/>	05 <input checked="" type="radio"/> 14 <input type="radio"/>	<b>00-7390-05-05</b> <b>00-7390-05-14</b>
05 <input checked="" type="radio"/> 05 <input checked="" type="radio"/>	05 <input checked="" type="radio"/> 14 <input type="radio"/>	<b>00-7391-05-05</b> <b>00-7391-05-14</b>
05 <input checked="" type="radio"/> 05 <input checked="" type="radio"/>	05 <input checked="" type="radio"/> 14 <input type="radio"/>	<b>00-9043-05-05</b> <b>00-9043-05-14</b>

 \*Bombilla no incluida.  
 \*Lâmpada não incluida.

## Attic 2 bodies Rectangular Shape 1200mm Side

QS

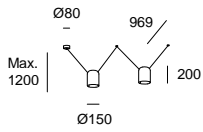
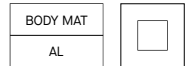

E27 | W 2 × Max. 15

Blanco Branco 14   
Negro Preto 05

Structure	Exterior Screen	Code
05 <input checked="" type="radio"/> 05 <input checked="" type="radio"/>	05 <input checked="" type="radio"/> 14 <input type="radio"/>	<b>00-7396-05-05</b> <b>00-7396-05-14</b>
05 <input checked="" type="radio"/> 05 <input checked="" type="radio"/>	05 <input checked="" type="radio"/> 14 <input type="radio"/>	<b>00-7397-05-05</b> <b>00-7397-05-14</b>
05 <input checked="" type="radio"/> 05 <input checked="" type="radio"/>	05 <input checked="" type="radio"/> 14 <input type="radio"/>	<b>00-9044-05-05</b> <b>00-9044-05-14</b>

\*Bombilla no incluída.  
\*Lâmpada não incluída.

## Attic 2 bodies Rectangular Shape 2200 mm Side

QS

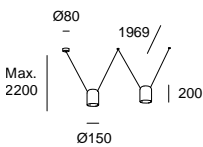
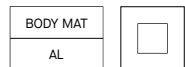

E27 | W 2 × Max. 15

Blanco Branco 14   
Negro Preto 05

Structure	Exterior Screen	Code
05 <input checked="" type="radio"/> 05 <input checked="" type="radio"/>	05 <input checked="" type="radio"/> 14 <input type="radio"/>	<b>00-7394-05-05</b> <b>00-7394-05-14</b>
05 <input checked="" type="radio"/> 05 <input checked="" type="radio"/>	05 <input checked="" type="radio"/> 14 <input type="radio"/>	<b>00-7395-05-05</b> <b>00-7395-05-14</b>
05 <input checked="" type="radio"/> 05 <input checked="" type="radio"/>	05 <input checked="" type="radio"/> 14 <input type="radio"/>	<b>00-9045-05-05</b> <b>00-9045-05-14</b>

\*Bombilla no incluída.  
\*Lâmpada não incluída.

## Attic 3 bodies Rectangular Shape 1200mm Side

QS

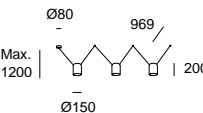
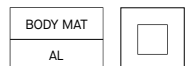

E27 | W 3 × Max. 15

Blanco Branco 14   
Negro Preto 05

Structure	Exterior Screen	Code
05 <input checked="" type="radio"/> 05 <input checked="" type="radio"/>	05 <input checked="" type="radio"/> 14 <input type="radio"/>	<b>00-7400-05-05</b> <b>00-7400-05-14</b>
05 <input checked="" type="radio"/> 05 <input checked="" type="radio"/>	05 <input checked="" type="radio"/> 14 <input type="radio"/>	<b>00-7401-05-05</b> <b>00-7401-05-14</b>
05 <input checked="" type="radio"/> 05 <input checked="" type="radio"/>	05 <input checked="" type="radio"/> 14 <input type="radio"/>	<b>00-9046-05-05</b> <b>00-9046-05-14</b>

\*Bombilla no incluída.  
\*Lâmpada não incluída.

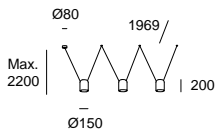
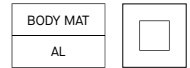

### Attic 3 bodies Rectangular Shape 2200mm Side

QS



E27 | W 3 × Max. 15

Blanco Branco 14 ○  
Negro Preto 05 ●

Structure	Exterior Screen	Code
 05 ● 05 ●	05 ● 14 ○	<b>00-7398-05-05</b> <b>00-7398-05-14</b>
 05 ● 05 ●	05 ● 14 ○	<b>00-7399-05-05</b> <b>00-7399-05-14</b>
 05 ● 05 ●	05 ● 14 ○	<b>00-9047-05-05</b> <b>00-9047-05-14</b>

\*Bombilla no incluída.  
\*Lâmpada não incluída.

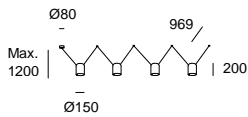
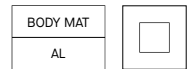

### Attic 4 bodies Rectangular Shape 1200mm Side

QS



E27 | W 4 × Max. 15

Blanco Branco 14 ○  
Negro Preto 05 ●

Structure	Exterior Screen	Code
 05 ● 05 ●	05 ● 14 ○	<b>00-7404-05-05</b> <b>00-7404-05-14</b>
 05 ● 05 ●	05 ● 14 ○	<b>00-7405-05-05</b> <b>00-7405-05-14</b>
 05 ● 05 ●	05 ● 14 ○	<b>00-9048-05-05</b> <b>00-9048-05-14</b>

\*Bombilla no incluída.  
\*Lâmpada não incluída.

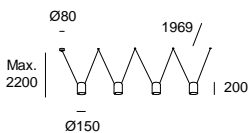
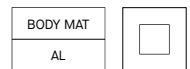

### Attic 4 bodies Rectangular Shape 2200mm Side

QS



E27 | W 4 × Max. 15

Blanco Branco 14 ○  
Negro Preto 05 ●

Structure	Exterior Screen	Code
 05 ● 05 ●	05 ● 14 ○	<b>00-7402-05-05</b> <b>00-7402-05-14</b>
 05 ● 05 ●	05 ● 14 ○	<b>00-7403-05-05</b> <b>00-7403-05-14</b>
 05 ● 05 ●	05 ● 14 ○	<b>00-9049-05-05</b> <b>00-9049-05-14</b>

\*Bombilla no incluída.  
\*Lâmpada não incluída.

# Super Attic



Performance Universe



P. 304



## Presencia contundente y armónica

La colección modular Attic se amplía con la llegada de la mayor de la familia: una pantalla cónica de gran tamaño que se adueña sin complejos del espacio dotándolo de presencia y gusto por los detalles. Puede personalizarse el color en cualquier RAL bajo petición.

## Presença forte e harmoniosa

A coleção modular Attic é ampliada com a chegada do maior da família: um quebra-luz cônico de grande dimensão que toma conta do espaço sem complexos, dotando-o de presença e gosto pelos detalhes. A cor pode ser personalizada em qualquer RAL, sob pedido.

# Configura tu Attic Configure a sua Attic

Configurador para personalización disponible.  
Configurador para personalização disponível.

[attic.ledsc4.com](http://attic.ledsc4.com)



## 1 Instalación Installation

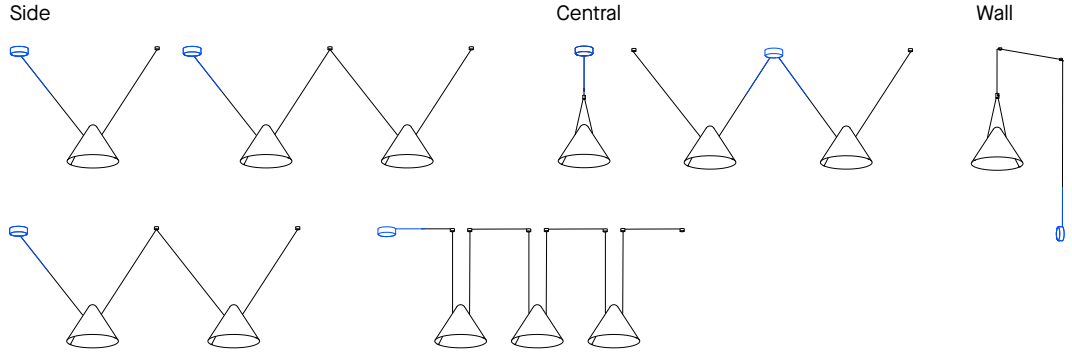

Con 2 opciones de instalación  
Con 2 opções de instalação

No hay opciones de instalación para el modelo individual con florón central.  
Não disponível para o modelo individual com roseta central.

## 2 Longitud de cable Comprimento do cabo

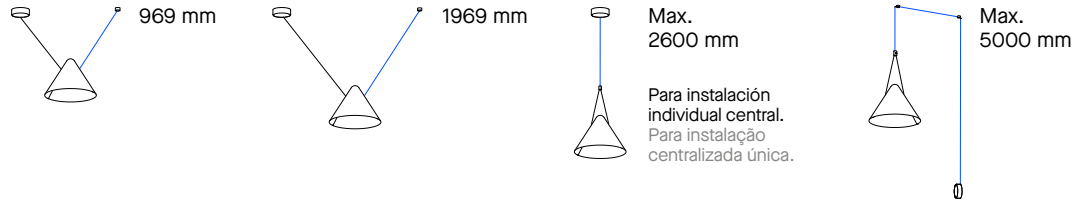

Max. 2600 mm  
Para instalación individual central.  
Para instalação centralizada única.

## 3 Combinaciones estandar Combinações standard

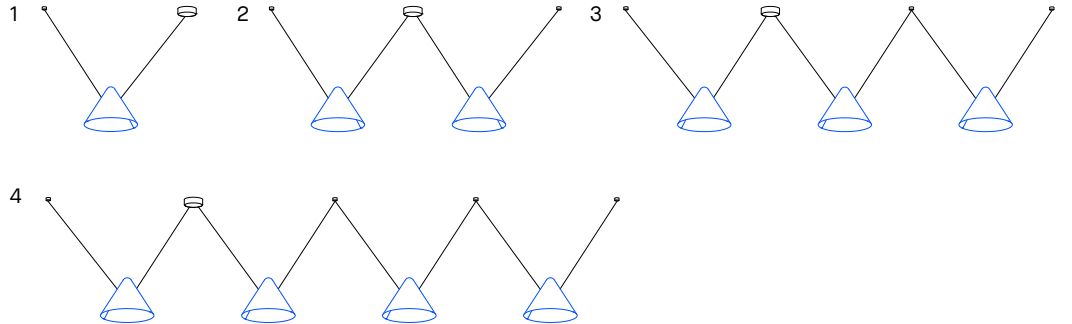

Más opciones a través del configurador.  
Mais opções através do configurador.

## 4 Acabados Acabamentos

05 Black

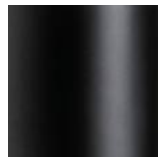

Múltiples colores personalizables bajo petición.  
Várias cores personalizáveis a pedido.

## Super Attic

QS

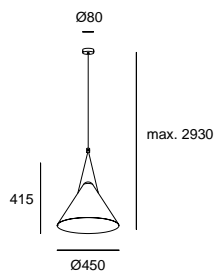
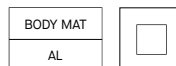

E27 | W Max. 15

Negro Preto 05 ●

Structure Exterior Screen

Code

05 ●

05 ●

00-8348-05-05

\*Bombilla no incluída.  
\*Lâmpada não incluída.

## Super Attic Shape V 1250mm

QS

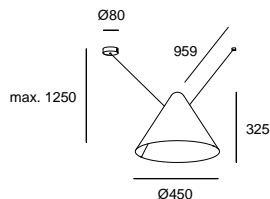
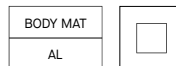

E27 | W Max. 15

Negro Preto 05 ●

Structure Exterior Screen

Code

05 ●

05 ●

00-8365-05-05

\*Bombilla no incluída.  
\*Lâmpada não incluída.

## Super Attic Shape V 2250mm

QS

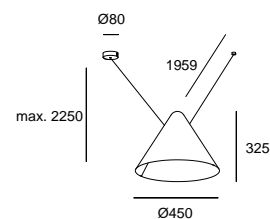
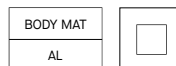

E27 | W Max. 15

Negro Preto 05 ●

Structure Exterior Screen

Code

05 ●

05 ●

00-8364-05-05

\*Bombilla no incluída.  
\*Lâmpada não incluída.

## Super Attic 2 bodies 1250mm Side

QS

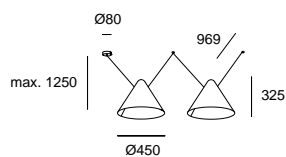
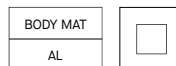

E27 | W 2 × Max. 15

Negro Preto 05 ●

Structure Exterior Screen

Code

05 ●

05 ●

00-8373-05-05

\*Bombilla no incluída.  
\*Lâmpada não incluída.

## Super Attic 2 bodies 2250mm Side

QS

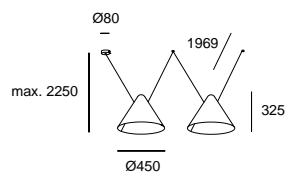
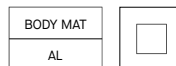

E27 | W 2 × Max. 15

Negro Preto 05 ●

Structure Exterior Screen

Code

05 ●

05 ●

00-8369-05-05

\*Bombilla no incluída.  
\*Lâmpada não incluída.

### Super Attic 3 bodies 1250mm Side

QS

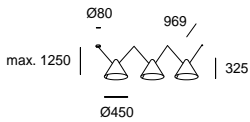

E27 | W 3 × Max. 15

BODY MAT  
AL



Negro Preto 05 ●

Structure Exterior Screen

Code

05 ● 05 ●

00-8381-05-05

\*Bombilla no incluída.  
\*Lâmpada não incluída.

### Super Attic 3 bodies 2250mm Side

QS

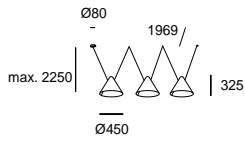

E27 | W 3 × Max. 15

BODY MAT  
AL



Negro Preto 05 ●

Structure Exterior Screen

Code

05 ● 05 ●

00-8377-05-05

\*Bombilla no incluída.  
\*Lâmpada não incluída.

### Super Attic 4 Bodies 1250mm Side

QS

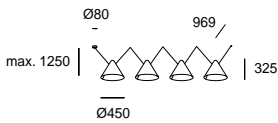

E27 | W 4 × Max. 15

BODY MAT  
AL



Negro Preto 05 ●

Structure

Code

05 ●

00-8389-05-05

\*Bombilla no incluída.  
\*Lâmpada não incluída.

### Super Attic 4 Bodies 2250mm Side

QS

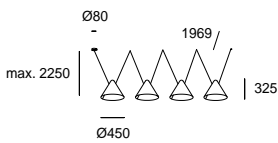

E27 | W 4 × Max. 15

BODY MAT  
AL



Negro Preto 05 ●

Structure

Code

05 ●

00-8385-05-05

\*Bombilla no incluída.  
\*Lâmpada não incluída.

H



## Performance Universe



P. 216



P. 258



P. 306

**Distinción natural**

De líneas simples y puras, H es una reinterpretación de la clásica pantalla donde el valor añadido es la confortabilidad de su luz. Ofrece tanto una luz funcional para trabajo, como al mismo tiempo, crea un delicado halo adicional gracias a la forma abierta y levemente hundida de la tija superior, creando un agradable juego de luces y sombras.

**Distinção natural**

De linhas simples e puras, H é uma reinterpretação do abajur clássico onde a mais-valia é o conforto da sua luz. Oferece tanto uma luz de trabalho funcional como cria uma auréola adicional delicada graças à forma aberta e ligeiramente afundada do espigão superior, criando um agradável jogo de luz e sombra.





Detalle del sutil efecto de luz superior.  
Pormenor do subtil efeito de luz superior.

## H Pendant Surface

BODY MAT	DIF MAT	□
ST	ACR	

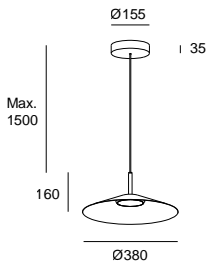

LED | K 2700 | CRI 90 | W Total 277 | Real Lm 1328

Negro Preto 05 ●  
Oro mate Ouro mate DN ●

	Structure	Code
 ON-OFF 220-240V	05 ●	<b>00-7742-05-05</b> QS
	DN ●	<b>00-7742-DN-DN</b> QS
DALI-2 220-240V	05 ●	<b>00-9050-05-05</b>
	DN ●	<b>00-9050-DN-DN</b>

## H Pendant Recessed

BODY MAT	DIF MAT	□
ST	ACR	

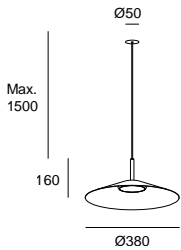

LED | K 2700 | CRI 90 | W Total 277 | Real Lm 1328

Negro Preto 05 ●  
Oro mate Ouro mate DN ●

	Body	Code
 ON-OFF 220-240V	05 ●	<b>00-9052-05-05</b>
	DN ●	<b>00-9052-DN-DN</b>
DALI-2 220-240V	05 ●	<b>00-9053-05-05</b>
	DN ●	<b>00-9053-DN-DN</b>

Florón negro  
Florão preta

# Napa



Essential Universe



## Diseño versátil

Napa es una pieza atemporal, neutra y de líneas suaves. El punto de luz que se insinúa en el vértice superior le confiere una elegancia particular. Sola o en composición, Napa proporciona una iluminación práctica y funcional capaz de armonizar cualquier espacio.

## Design versátil

Napa é uma peça intemporal, neutra e de linhas suaves. O ponto de luz que se insinua no vértice superior confere-lhe uma elegância particular. Sozinha ou em composição, Napa proporciona uma iluminação prática e funcional capaz de harmonizar qualquer espaço.

Distintas combinaciones de acabados para la pantalla y sus detalles.

Diferentes combinações de acabamentos para o quebra-luz e os seus detalhes.



05-05



05-DN



Florón negro  
Florão preta

### Napa Small

QS

BODY MAT  
ST

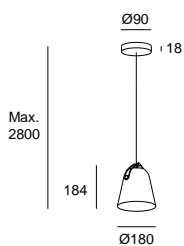

E27 | W Max. 15

Negro Preto 05 ●  
Oro mate Ouro mate DN ●

Body

Button

Code

05 ●  
05 ●

05 ●  
DN ●

00-7992-05-05  
00-7992-05-DN

\*Bombilla no incluida.  
\*Lâmpada não incluída.

### Napa Big

QS

BODY MAT  
ST

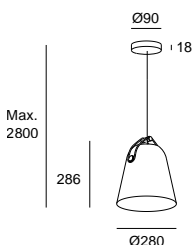

E27 | W Max. 15

Negro Preto 05 ●  
Oro mate Ouro mate DN ●

Body

Button

Code

05 ●  
05 ●

05 ●  
DN ●

00-7993-05-05  
00-7993-05-DN

\*Bombilla no incluida.  
\*Lâmpada não incluída.

# Candle



Performance Universe



## Reinterpretación de un clásico

Esta delicada luminaria es la reinterpretación contemporánea de la clásica vela. La luz está trabajada respetando la esencia de esta inspiración, ofreciendo calidez y armonía. Desde la simplicidad de la pieza inicial hasta la complejidad compositiva del chandelier, Candle se ha transformado en una colección viva que cambia sustancialmente con la incorporación de sus dos accesorios, el disco y esfera. Formas esenciales que mantienen la delicadeza inicial de la colección.

## Reinterpretação de um clássico

Esta delicada luminária é a reinterpretação contemporânea de uma clássica vela. A luz é trabalhada respeitando a essência desta inspiração, oferecendo calidez e harmonia. Da simplicidade da peça inicial à complexidade compositiva do chandelier, Candle transformou-se numa coleção viva que muda substancialmente com a incorporação dos seus dois acessórios, o disco e a esfera. Formas essenciais que mantêm a delicadeza inicial da coleção.



## Candle 1 Body Surface

QS

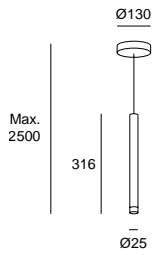

LED | K 2700 | CRI 90 | W Total 4.1 | Real Lm 154



ON-OFF 100-240V

Body

Code

27 ●  
60 ●00-6017-27-27  
00-6017-60-60

BODY MAT
ST,AL

DIF MAT
PMMA

Negro Preto 60 ●  
Latonado Latão 27 ●Florón negro  
Florão preta

## Candle 1 Body Recessed

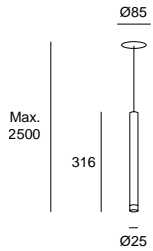

LED | K 2700 | CRI 90 | W Total 4.1 | Real Lm 154



ON-OFF 100-240V

Body

Code

27 ●  
60 ●00-6018-27-27  
00-6018-60-60

BODY MAT
ST,AL

DIF MAT
PMMA

Negro Preto 60 ●  
Latonado Latão 27 ●

 65 3-30 mm  
Florón blanco  
Florão branco

## Candle XXS 1 Body Surface

QS

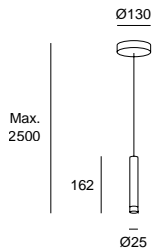

LED | K 2700 | CRI 90 | W Total 4.1 | Real Lm 154



ON-OFF 100-240V

Body

Code

27 ●  
60 ●00-8527-27-27  
00-8527-60-60

BODY MAT
ST,AL

DIF MAT
PMMA

Negro Preto 60 ●  
Latonado Latão 27 ●Florón negro  
Florão preta

## Candle XXS 1 Body Recessed

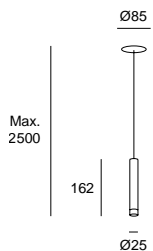

LED | K 2700 | CRI 90 | W Total 4.1 | Real Lm 154



ON-OFF 100-240V

Body

Code

27 ●  
60 ●00-8528-27-27  
00-8528-60-60

BODY MAT
ST,AL

DIF MAT
PMMA

Negro Preto 60 ●  
Latonado Latão 27 ●

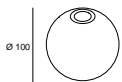
 65 3-30 mm  
Florón blanco  
Florão branco
No incluido  
Não incluidoDisco de aluminio (1 unidad)  
Disco de aluminio (1 unidade)

71-6022-60-60

Disco de aluminio (1 unidad)  
Disco de aluminio (1 unidade)

71-6022-27-27

Accesorio Candle difusor vidrio matizado (1 unidad)  
Acessório Candle difusor vidro matizado (1 unidade)

71-8318-F9-F9

## Candle 3 Bodies

QS

BODY MAT	DIF MAT
ST,AL	PMMA

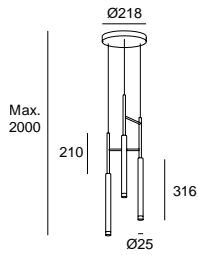

LED | K 2700 | CRI 90 | W Total 11.5 | Real Lm 461

Negro Preto 60 ●  
Latonado Latão 27 ●

	Body	Code
PHASE CUT 220-240V	27 ●	00-6021-27-27
	60 ●	00-6021-60-60

Florón negro  
Florão preta

## Candle 5 Bodies Chandelier

BODY MAT	DIF MAT
ST,AL	PMMA

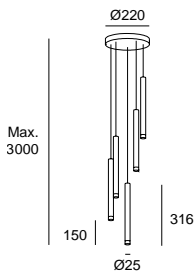

LED | K 2700 | CRI 90 | W Total 16.8 | Real Lm 844

Negro Preto 60 ●  
Latonado Latão 27 ●

	Canopy	Body	Code
DALI-2 100-240V	60 ●	27 ●	00-8317-60-27
	60 ●	60 ●	00-8317-60-60

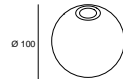

No incluido / Não incluído

Accesorio Candle difusor vidrio matizado (1 unidad)  
Acessório Candle difusor vidro matizado (1 unidade)

71-8318-F9-F9

## Candle XXS 5 Bodies Chandelier

BODY MAT	DIF MAT
ST,AL	PMMA

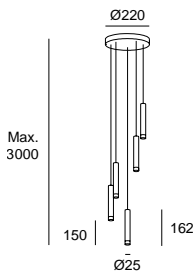

LED | K 2700 | CRI 90 | W Total 16.8 | Real Lm 844

Negro Preto 60 ●  
Latonado Latão 27 ●

	Canopy	Body	Code
DALI-2 100-240V	60 ●	27 ●	00-8537-60-27
	60 ●	60 ●	00-8537-60-60

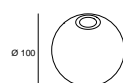

No incluido / Não incluído

Accesorio Candle difusor vidrio matizado (1 unidad)  
Acessório Candle difusor vidro matizado (1 unidade)

71-8318-F9-F9

## Candle 18 Bodies

BODY MAT
ST,AL

DIF MAT
PMMA

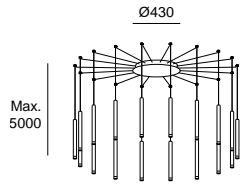

LED | K 2700 | CRI 90 | W Total 60.2 | Real Lm 2765

Blanco Branco 14   
 Negro Preto 60   
 Latonado Latão 27

	Canopy	Body	Code
0-10V 100-277V	14 <input type="radio"/>	27 <input type="radio"/>	<b>00-6666-14-27</b>
	14 <input type="radio"/>	60 <input type="radio"/>	<b>00-6666-14-60</b>
DALI 100-277V	14 <input type="radio"/>	27 <input type="radio"/>	<b>00-6667-14-27</b>
	14 <input type="radio"/>	60 <input type="radio"/>	<b>00-6667-14-60</b>

## Candle XXS 18 Bodies

BODY MAT
ST,AL

DIF MAT
PMMA

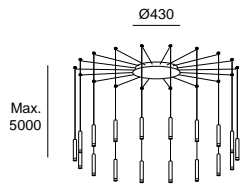

LED | K 2700 | CRI 90 | W Total 60.2 | Real Lm 2765

Blanco Branco 14   
 Negro Preto 60   
 Latonado Latão 27

	Canopy	Body	Code
0-10V 100-277V	14 <input type="radio"/>	27 <input type="radio"/>	<b>00-8533-14-27</b>
	14 <input type="radio"/>	60 <input type="radio"/>	<b>00-8533-14-60</b>
DALI 100-277V	14 <input type="radio"/>	27 <input type="radio"/>	<b>00-8534-14-27</b>
	14 <input type="radio"/>	60 <input type="radio"/>	<b>00-8534-14-60</b>

## Candle 30 Bodies

BODY MAT
ST,AL

DIF MAT
PMMA

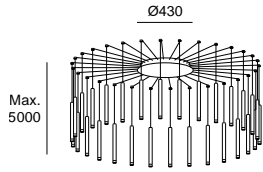

LED | K 2700 | CRI 90 | W Total 109.4 | Real Lm 4608

Blanco Branco 14

Negro Preto 60

Latonado Latão 27

	Canopy	Body	Code
O-10V 100-277V	14 <input type="radio"/>	27 <input type="radio"/>	<b>00-6668-14-27</b>
	14 <input type="radio"/>	60 <input type="radio"/>	<b>00-6668-14-60</b>
DALI 100-277V	14 <input type="radio"/>	27 <input type="radio"/>	<b>00-6669-14-27</b>
	14 <input type="radio"/>	60 <input type="radio"/>	<b>00-6669-14-60</b>

## Candle XXS 30 Bodies

BODY MAT
ST,AL

DIF MAT
PMMA

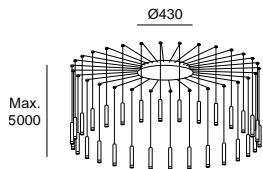

LED | K 2700 | CRI 90 | W Total 109.4 | Real Lm 4608

Blanco Branco 14

Negro Preto 60

Latonado Latão 27

	Canopy	Body	Code
O-10V 100-277V	14 <input type="radio"/>	27 <input type="radio"/>	<b>00-8535-14-27</b>
	14 <input type="radio"/>	60 <input type="radio"/>	<b>00-8535-14-60</b>
DALI 100-277V	14 <input type="radio"/>	27 <input type="radio"/>	<b>00-8536-14-27</b>
	14 <input type="radio"/>	60 <input type="radio"/>	<b>00-8536-14-60</b>

# Invisible



## Performance Universe

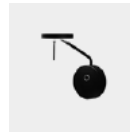

P. 184



P. 226



P. 262

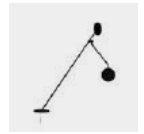

P. 292



### Movimiento en equilibrio

Francesc Vilaró se inspiró en los móviles del escultor Alexander Calder para diseñar la colección Invisible, buscando el equilibrio entre las líneas que forman la estructura y el círculo que las une haciendo de contrapeso. En esta composición de balances, la luz puede dirigirse a cualquier punto, proyectando una luz de acento de forma muy honesta, con una gran libertad de movimientos en todas sus versiones. Invisible es una pieza icónica que ha recibido el premio German Design Award.



### Movimento em equilíbrio

Francesc Vilaró inspirou-se nos móveis do escultor Alexander Calder para criar a coleção Invisible, procurando um equilíbrio entre as linhas que formam a estrutura e o círculo que as une como contrapeso. Nesta composição de equilíbrios, a luz pode ser dirigida para qualquer ponto, projetando uma luz de realce de uma forma muito honesta, com uma grande liberdade de movimentos em todas as suas versões. Invisible é uma peça icónica que recebeu o German Design Award.



## Invisible Single Fixed

QS

BODY MAT	DIF MAT		
ST.AL	PMMA		

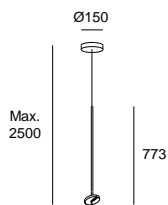

LED | CRI 90 | W Total 12.2

Negro Preto 05 ●

	K	Real Lm	Structure	Code
PHASE CUT 220-240V	2700	551	05 ●	<b>00-7382-05-05</b>
	3000	568	05 ●	<b>00-5693-05-05</b>

## Invisible Single Adjustable

QS

BODY MAT	DIF MAT			
ST.AL	PMMA			

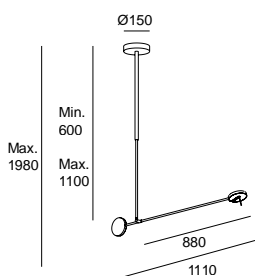



LED | CRI 90 | W Total 10.5

Negro Preto 05 ●

	K	Real Lm	Structure	Code
PHASE CUT 220-240V	2700	534	05 ●	<b>00-7383-05-05</b>
	3000	550	05 ●	<b>00-5694-05-05</b>

## Invisible 3 Bodies

BODY MAT	DIF MAT		
ST.AL	PMMA		

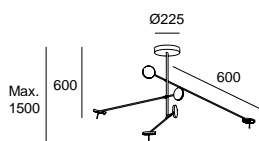

LED | CRI 90 | W Total 28.5

Negro Preto 05 ●

	K	Real Lm	Structure	Code
ON-OFF 100-240V	2700	1602	05 ●	<b>00-7384-05-05</b> QS
ON-OFF 100-240V	3000	1650	05 ●	<b>00-5695-05-05</b>
PHASE CUT 220-240V	2700	1602	05 ●	<b>00-7385-05-05</b> QS
PHASE CUT 220-240V	3000	1650	05 ●	<b>00-5696-05-05</b> QS

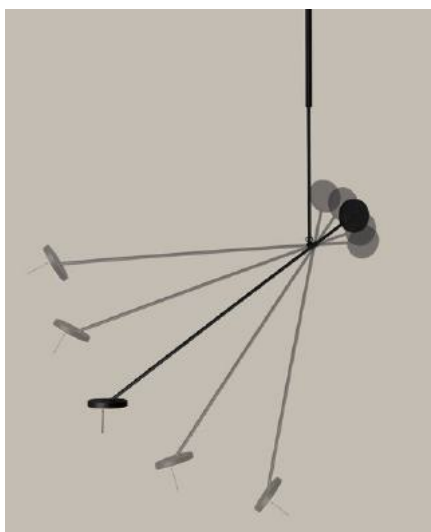

La rotación del cabezal permite dirigir la luz.  
A rotação do cabeçal permite dirigir a luz.

# Prolix



## Performance Universe



P. 294



P. 350



### Estilo y elegancia

Contemporaneidad, estilo y control del ángulo luz son los pilares sobre los que se sustenta esta propuesta de Nahrang. Prolix, no sólo presume de su silueta facetada, sino que cuenta con una gran ventaja técnica gracias a una óptica avanzada que posibilita graduar el ángulo de luz para conseguir el efecto de iluminación deseado.

### Estilo e elegância

Contemporaneidade, estilo e controlo do ângulo de luz são os pilares sobre os quais esta proposta de Nathrang se baseia. Prolix não só ostenta a sua silhueta facetada, como também uma grande vantagem técnica graças a uma óptica avançada que permite ajustar o ângulo de luz para obter o efeito de iluminação desejado.



Óptica regulable para aumentar el ángulo de luz. (Zoom 15°-50°)  
Ótica regulável para aumentar o ângulo da luz. (Zoom 15°-50°)



Llave para ajustar la óptica de forma manual.  
Chave para ajustar a ótica manualmente.

## Prolix Surface

QS

BODY MAT	DIF MAT
AL	PMMA

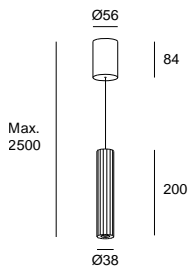

LED | K 2700 | CRI 90 | W Total 10.4 | Real Lm 320

Negro Preto 05 ●  
Oro mate Ouro mate DN ●

	Canopy	Body	Code
PHASE CUT 220-240V	05 ● DN ●	05 ● DN ●	00-8513-05-05 00-8513-DN-DN

QS Quick Service | 2-6 días laborables (tiempo de transporte no incluido)  
Quick Service | 2-6 dias úteis (tempo de transporte não incluído)

## Prolix Recessed

BODY MAT	DIF MAT
AL	PMMA

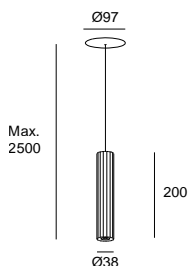

LED | K 2700 | CRI 90 | W Total 10.4 | Real Lm 320

Negro Preto 05 ●  
Oro mate Ouro mate DN ●

	Body	Code
PHASE CUT 220-240V	05 ● DN ●	00-8514-05-05 00-8514-DN-DN

65 3-30 mm

Florón blanco  
Florão branco

# Dew



## Performance Universe



### La belleza de lo efímero

Dew es una composición orgánica que explora la luz y la belleza efímera, inspirándose en las gotas del rocío una mañana de primavera. Con una configuración lineal formada por una línea de puntos ovalados conectados por piezas de aluminio a distancias variables, esta colección es una colección decorativa con un fuerte carácter técnico. Dew se presenta con variaciones tanto verticales como horizontales, lo que hace posible cualquier combinación y ángulo.

### A beleza do efêmero

Dew é uma composição orgânica que explora a luz e a beleza efêmera, inspirada nas gotas de orvalho numa manhã de primavera. Com uma configuração linear formada por uma linha de pontos ovais ligados por peças de alumínio a distâncias variáveis, esta coleção é uma coleção decorativa com um forte carácter técnico. Dew apresenta-se com variações tanto verticais como horizontais, tornando possível qualquer combinação e ângulo.

Compatible con instalaciones que precisen de grandes alturas.  
Compatível com instalações que exijam grandes alturas.









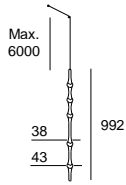

## Dew 992mm

BODY MAT	DIF MAT
AL	PC

LED | K 2700 | CRI 90 | W Total 13 | Real Lm 782

Negro Preto 05 ●  
Blanco opal Branco opalino M1 ○



	Structure	Difusor	Code
 Ø160  DALI 220-240V	05 ●	M1 ○	<b>00-8304-05-M1</b> QS
 Ø97  0-10V 220-240V	05 ●	M1 ○	<b>00-8305-05-M1</b>
 Ø50  PUSH 220-240V	05 ●	M1 ○	<b>00-8656-05-M1</b>
 Ø50  PUSH 220-240V	05 ●	M1 ○	<b>00-8658-05-M1</b>







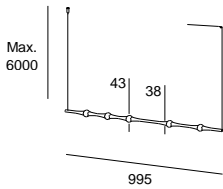

## Dew 995mm

BODY MAT	DIF MAT
AL	PC

LED | K 2700 | CRI 90 | W Total 13 | Real Lm 782

Negro Preto 05 ●  
Blanco opal Branco opalino M1 ○



	Structure	Difusor	Code
 Ø160  DALI 220-240V	05 ●	M1 ○	<b>00-8302-05-M1</b> QS
 Ø97  0-10V 220-240V	05 ●	M1 ○	<b>00-8303-05-M1</b>
 Ø50  PUSH 220-240V	05 ●	M1 ○	<b>00-8646-05-M1</b>
 Ø50  PUSH 220-240V	05 ●	M1 ○	<b>00-8648-05-M1</b>







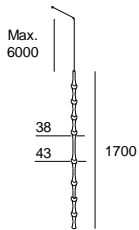

## Dew 1700mm

BODY MAT	DIF MAT
AL	PC

LED | K 2700 | CRI 90 | W Total 21.1 | Real Lm 1383

Negro Preto 05 ●  
Blanco opal Branco opalino M1 ○



	Structure	Difusor	Code
 Ø160  DALI 220-240V	05 ●	M1 ○	<b>00-8306-05-M1</b> QS
 Ø97  0-10V 220-240V	05 ●	M1 ○	<b>00-8307-05-M1</b>
 Ø50  PUSH 220-240V	05 ●	M1 ○	<b>00-8667-05-M1</b>
 Ø50  PUSH 220-240V	05 ●	M1 ○	<b>00-8669-05-M1</b>

Florón en superficie  
Florão de superfície

Florón empotrado  
Florão encastrado

Florón empotrado mini  
Florão encastrado mini



# Alive



Performance Universe



## Transición del vacío hacia el punto de luz

Alive representa la mínima expresión para llegar al punto de luz de forma silenciosa. Con una progresión armónica, su diseño responde a una transición del vacío hacia la luz. Esta reducción cambia cuando la composición se realiza con el difusor de cristal matizado que se opaliza progresivamente, pasando de una luz de acento a una luz ambiental muy agradable.

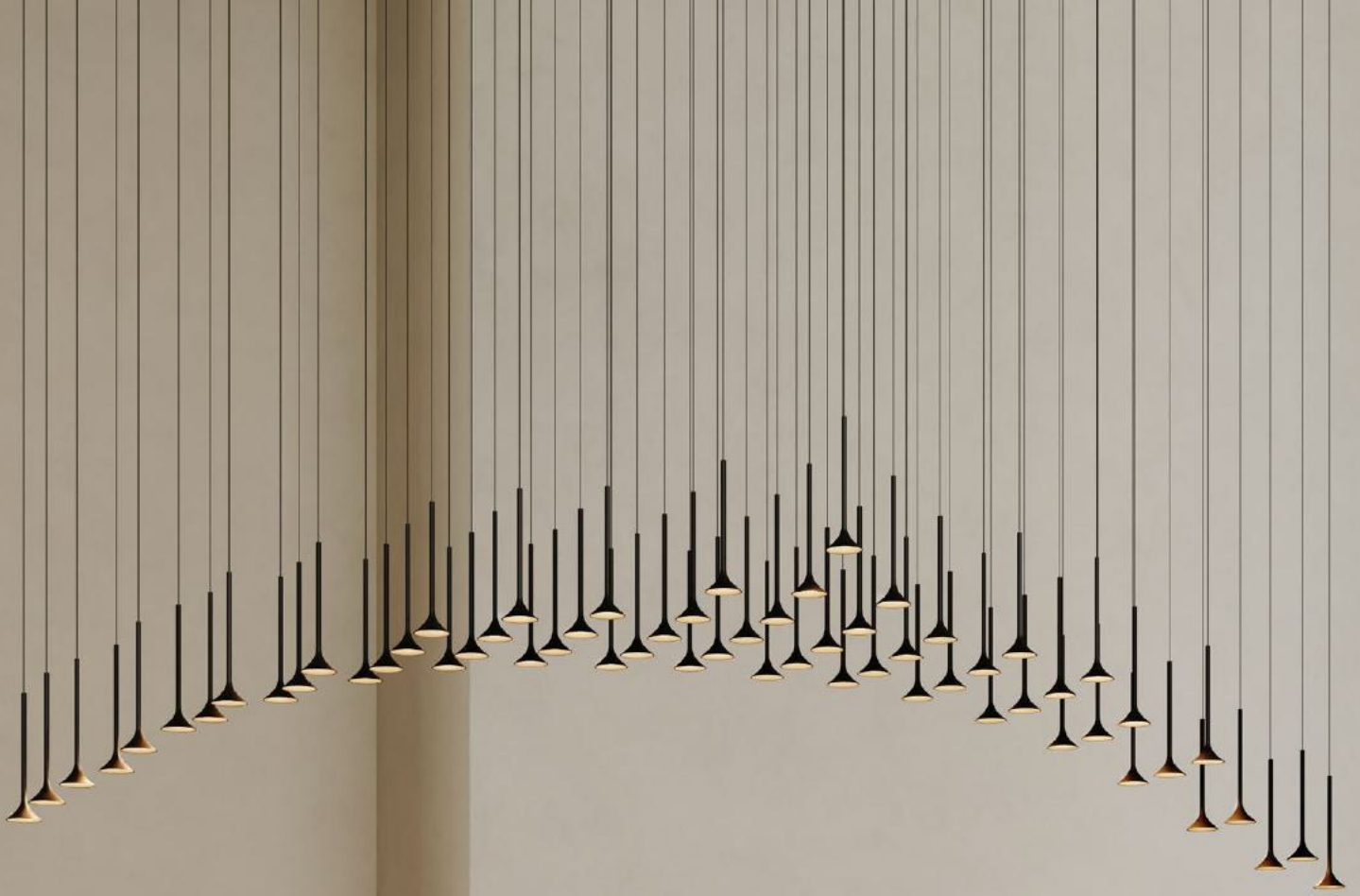

## Transição do vazio para o ponto de luz

Alive representa a expressão mínima para atingir o ponto de luz de forma silenciosa. Com uma progressão harmónica, o seu design responde a uma transição do vazio para a luz. Esta redução muda quando a composição é feita com o difusor em vidro matizado que se torna progressivamente opaco, passando de uma luz de realce para uma luz ambiente muito agradável.



## Alive Single

QS

BODY MAT	DIF MAT		
ST,AL	PMMA		

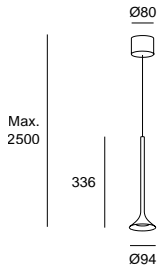

LED | K 2700 | CRI 80 | W Total 8.5 | Real Lm 492

Negro Preto 05 ●



ON-OFF 100-240V

Structure



Code

05 ●

00-6670-05-05

## Alive Single with glass difusor

QS

BODY MAT	DIF MAT		
ST,AL	PMMA, GLA		

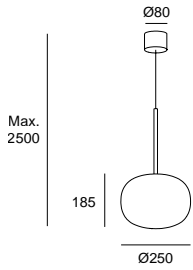

LED | K 2700 | CRI 80 | W Total 8.5 | Real Lm 454

Negro Preto 05 ●  
Cristal arenado Vidro fosco F1 ○

ON-OFF 100-277V

Structure

Difusor

Code

05 ●

F1 ○

00-6671-05-F1



Opción con difusor oval de cristal matizado soplado artesanalmente.  
Opção com difusor oval de vidro matizado soprado artesanalmente.

# Punto



Essential Universe



## Gran personalidad en un mínimo punto de luz

Punto es una colección de colgantes que concentra una gran personalidad en un mínimo punto de luz. La versión simple se integra en el espacio de forma discreta y suave; la opción múltiple, en cambio, puede componerse de una forma mucho más compleja, siempre conservando su alto valor estético.

## Grande personalidade num mínimo ponto de luz

Punto é uma coleção de suspensos que concentra uma grande personalidade num mínimo ponto de luz. A versão simples integra-se no espaço de forma discreta e suave; a opção múltipla, por outro lado, pode ser composta de uma forma muito mais complexa, conservando sempre o seu alto valor estético.



### Punto Single Surface

QS

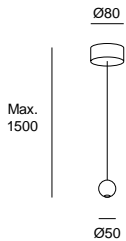

LED | K 3000 | CRI 90 | W Total 6.5 | Real Lm 329

Negro Preto 05 ●



Structure

Code

ON-OFF 220-240V

05 ●

00-A232-05-05

### Punto Single Recessed

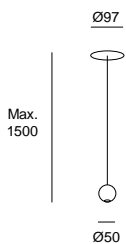
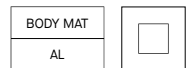

LED | K 3000 | CRI 90 | Real Lm 329

Negro Preto 05 ●



W Total

Structure

Code

PHASE CUT / PUSH 220-240V

6.5

05 ●

00-7900-05-05

DALI-2 / PUSH 100-240V

8.2

05 ●

00-7901-05-05

ON-OFF 100-277V

6.5

05 ●

00-7899-05-05

65  3-30 mm

Floron blanco  
Florao branco

### Punto Multiple Surface

QS

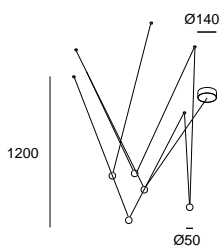

LED | K 3000 | CRI 90 | W Total 24.3 | Real Lm 625

Negro Preto 05 ●



Structure

Code

ON-OFF 220-240V

05 ●

00-A337-05-05

# Mist



## Essential Universe



P. 368



### Un clásico contemporáneo

Con sencillez y acierto Mist representa la renovación de un clásico.

### Um clássico contemporâneo

Com simplicidade e acerto Mist representa a renovação de um clássico.

#### Mist Pendant

BODY MAT	DIF MAT		IP
ST	GLA		44

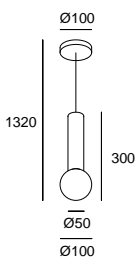

E14 Max. L 97 mm - Ø 35 mm | W Max. 9

**Structure**      **Difusor**

- |      |      |
|------|------|
| 05 ● | F9 ○ |
| 21 ● | F9 ○ |

**Code**

**00-8337-05-F9**  
**00-8337-21-F9**

- |                |    |   |
|----------------|----|---|
| Negro Preto    | 05 | ● |
| Cromo Cromado  | 21 | ● |
| Arenado Areado | F9 | ○ |

# Circ



## Performance Universe



### La elegancia de las formas neutras

Inspirándose en las tradicionales carpas de circo, el diseñador Josep Patsí crea una luminaria circular con distintas medidas y composiciones que se adapta a los espacios con la elegancia de una forma neutra, sin elementos añadidos.

### A elegância das formas neutras

Inspirada nas tradicionais tendas de circo, o designer Josep Patsí criou uma luminária circular com diferentes tamanhos e composições que se adapta a espaços com a elegância de uma forma neutra, sem elementos adicionados.



Modelos individuales o múltiples.  
Modelos individuais ou múltiplos.

### Circ Ø600

BODY MAT	DIF MAT	
ST,AL	PMMA	

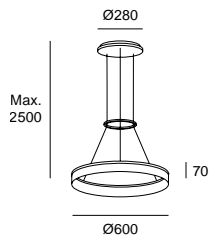

LED | K 3000 | CRI 80 | W Total 31 | Real Lm 1577

Blanco Branco BW   
Anodizado Anodizado M3

	Canopy	Structure	Code
ON-OFF 100-240V	BW <input type="radio"/>	M3 <input checked="" type="radio"/>	<b>00-0001-BW-M3</b>
1-10V 100-240V	BW <input type="radio"/>	M3 <input checked="" type="radio"/>	<b>00-0641-BW-M3</b>

### Circ Ø800

BODY MAT	DIF MAT	
ST,AL	PMMA	

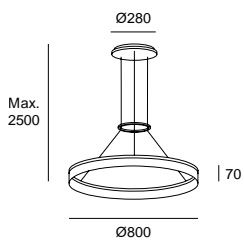

LED | K 3000 | CRI 80 | W Total 45.1 | Real Lm 2086

Blanco Branco BW   
Anodizado Anodizado M3

	Canopy	Structure	Code
ON-OFF 100-240V	BW <input type="radio"/>	M3 <input checked="" type="radio"/>	<b>00-0002-BW-M3</b>
1-10V 100-240V	BW <input type="radio"/>	M3 <input checked="" type="radio"/>	<b>00-0642-BW-M3</b>

## Circ Ø1000

BODY MAT	DIF MAT
ST,AL	PMMA

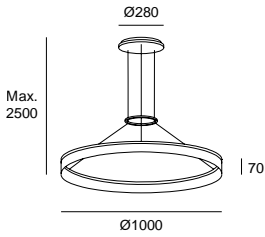

LED | K 3000 | CRI 80 | W Total 49.3 | Real Lm 3473

 Blanco Branco BW   
 Anodizado Anodizado M3 

	Canopy	Structure	Code
ON-OFF 100-240V	BW <input type="radio"/>	M3 <input checked="" type="radio"/>	<b>00-3642-BW-M3</b>
1-10V 100-240V	BW <input type="radio"/>	M3 <input checked="" type="radio"/>	<b>00-3646-BW-M3</b>

## Circ Ø600 + Ø800

BODY MAT	DIF MAT
ST,AL	PMMA

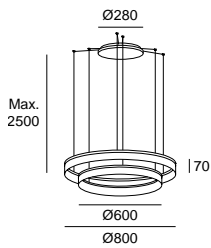

LED | K 3000 | CRI 80 | W Total 58 | Real Lm 3799

 Blanco Branco BW   
 Anodizado Anodizado M3 

	Canopy	Structure	Code
ON-OFF 100-240V	BW <input type="radio"/>	M3 <input checked="" type="radio"/>	<b>00-3647-BW-M3</b>

## Circ Ø800 + Ø1000

BODY MAT	DIF MAT
ST,AL	PMMA

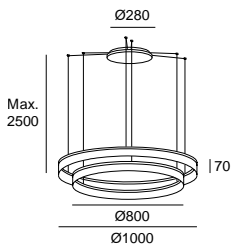

LED | K 3000 | CRI 80 | W Total 72 | Real Lm 6171

 Blanco Branco BW   
 Anodizado Anodizado M3 

	Canopy	Structure	Code
ON-OFF 100-240V	BW <input type="radio"/>	M3 <input checked="" type="radio"/>	<b>00-3648-BW-M3</b>

## Circ Ø600 + Ø800 + Ø1000

BODY MAT	DIF MAT
ST,AL	PMMA

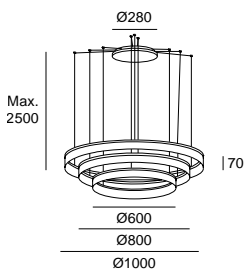

LED | K 3000 | CRI 80 | W Total 94 | Real Lm 7136

 Blanco Branco BW   
 Anodizado Anodizado M3 

	Canopy	Structure	Code
ON-OFF 100-240V	BW <input type="radio"/>	M3 <input checked="" type="radio"/>	<b>00-3649-BW-M3</b>

# Caprice



Performance Universe



P. 344



## Exigencia lumínica

Caprice ofrece diversidad de funciones avanzadas en un producto decorativo que se adapta a ambientes con grandes exigencias lumínicas.

## Exigência lumínica

Caprice oferece diversidade de funções avançadas num produto decorativo que se adapta a ambientes com grandes exigências lumínicas.

Cuenta con un switch integrado.  
Possui um switch integrado.

## Caprice Ø240mm

BODY MAT	DIF MAT		SWITCH CCT
ST	ACR		2700-3000-4000

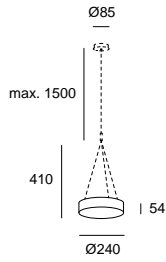

LED | K SW 2700-3000-4000 | CRI 90 | W Total 14.1 | Real Lm 896

Blanco Branco 14   
 Negro Preto 60   
 Blanco opal Branco opalino M1

	Body	Difussor	Code
PHASE CUT 220-240V	14 <input type="radio"/> 60 <input checked="" type="radio"/>	M1 <input type="radio"/> M1 <input type="radio"/>	<b>15-6196-14-M1</b> <b>15-6196-60-M1</b>

Acabados The Colours bajo pedido mínimo de 15 unidades. Consultar precios en tarifa y plazos de entrega con equipo comercial.  
 Acabamentos The Colours sujeitos a encomenda mínima de 15 unidades. Consultar preços e prazos de entrega com a nossa equipa comercial.

Body:  DL Oro Ouro Difussor:  M1 Blanco opal Branco opalino

## Caprice Ø330mm

BODY MAT	DIF MAT		SWITCH CCT
ST	ACR		2700-3000-4000

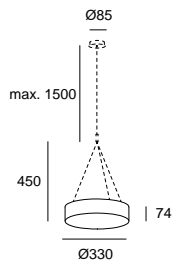

LED | K SW 2700-3000-4000 | CRI 90 | W Total 20 | Real Lm 1258

Blanco Branco 14   
 Negro Preto 60   
 Blanco opal Branco opalino M1

	Body	Difussor	Code
PHASE CUT 220-240V	14 <input type="radio"/> 60 <input checked="" type="radio"/>	M1 <input type="radio"/> M1 <input type="radio"/>	<b>15-6197-14-M1</b> <b>15-6197-60-M1</b>

Acabados The Colours bajo pedido mínimo de 15 unidades. Consultar precios en tarifa y plazos de entrega con equipo comercial.  
 Acabamentos The Colours sujeitos a encomenda mínima de 15 unidades. Consultar preços e prazos de entrega com a nossa equipa comercial.

Body:  DL Oro Ouro Difussor:  M1 Blanco opal Branco opalino

## Caprice Ø520mm

BODY MAT	DIF MAT		SWITCH CCT
ST	ACR		2700-3000-4000

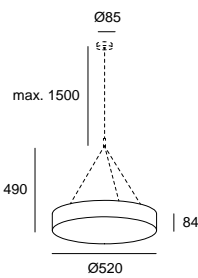

LED | K SW 2700-3000-4000 | CRI 90 | W Total 39.6 | Real Lm 3072

Blanco Branco 14   
 Negro Preto 60   
 Blanco opal Branco opalino M1

	Body	Difussor	Code
PHASE CUT 220-240V	14 <input type="radio"/> 60 <input checked="" type="radio"/>	M1 <input type="radio"/> M1 <input type="radio"/>	<b>15-6433-14-M1</b> <b>15-6433-60-M1</b>

Acabados The Colours bajo pedido mínimo de 15 unidades. Consultar precios en tarifa y plazos de entrega con equipo comercial.  
 Acabamentos The Colours sujeitos a encomenda mínima de 15 unidades. Consultar preços e prazos de entrega com a nossa equipa comercial.

Body:  DL Oro Ouro Difussor:  M1 Blanco opal Branco opalino

No incluidos y requeridos  
 Não incluído e requeridos

Kit suspensión blanco  
 Kit suspensão branco

71-6196-14-14

\*Consulte condiciones y plazos de entrega a nuestro equipo comercial.

\*Consultar a nossa equipa comercial para informações sobre as condições e os prazos de entrega.

# Pipe



Essential Universe



P. 196



P. 354



## Funcionalidad

Pipe es sinónimo de practicidad e integración. Un diseño funcional que permite cierta personalización para que su instalación siempre sea un acierto.

## Funcionalidade

Pipe é sinónimo de praticidade e integração. Um design funcional que permite uma certa personalização para que a sua instalação seja sempre um acerto.

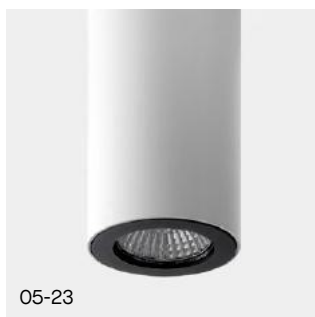

05-23



14-05



14-14



05-05

Combinaciones standard.  
Combinações padrão.

Posibilidad de otras combinaciones mediante aros no incluidos.  
Possibilidade de outras combinações por aros não incluídos.

## Pipe 300mm

QS

BODY MAT  
ST,AL

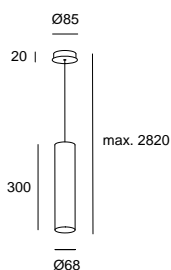

GU10 | W Max. 8

Blanco Branco 14 ○  
Negro Preto 05 ●  
Oro Ouro 23 ●

Structure	Ring	Code
05 ●	23 ●	00-5456-05-23
14 ○	05 ●	00-5456-14-05

\*Bombilla no incluída.  
\*Lâmpada não incluída.

### No incluido / Não incluído

Accesorio para empotrar el florón blanco 71-5456-14-14  
Acessório para encastrar o florão branco

Acc. comunes no incluídos  
Ac. comuns não incluídos

Aro blanco 71-0073-14-14  
Aro branco  
Aro negro 71-0073-05-05  
Aro preto

# Stylus



Essential Universe



P. 198



P. 355



## Sencillez y funcionalidad

Stylus es un diseño altamente funcional y versátil gracias a sus medidas y acabados.

## Simplicidade e funcionalidade

Stylus é um design altamente funcional e versátil graças às suas medidas e acabamentos.

## Stylus Surfaced 600mm

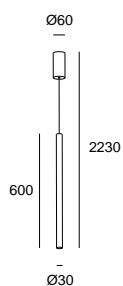

BODY MAT	DIF MAT	
AL	PC	

Blanco Branco 14

Negro Preto 05

Oro mate Ouro mate DN

LED | K 3000 | CRI 90 | W Total 9.7 | Real Lm 412

	Canopy	Body	Code
ON-OFF 220-240V	05 14 DN	05 14 DN	<b>00-A017-05-05</b> <b>00-A017-14-14</b> <b>00-A017-DN-DN</b>

## Stylus Recessed 600mm

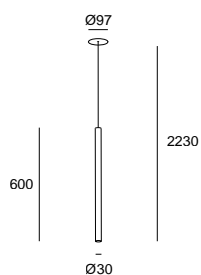

BODY MAT	DIF MAT	
AL	PC	

Blanco Branco 14

Negro Preto 05

Oro mate Ouro mate DN

LED | K 3000 | CRI 90 | W Total 9.7 | Real Lm 412

	Body	Code
ON-OFF 220-240V	05 14 DN	<b>00-A018-05-05</b> <b>00-A018-14-14</b> <b>00-A018-DN-DN</b>

3-30 mm 65

# Bravo



Performance Universe

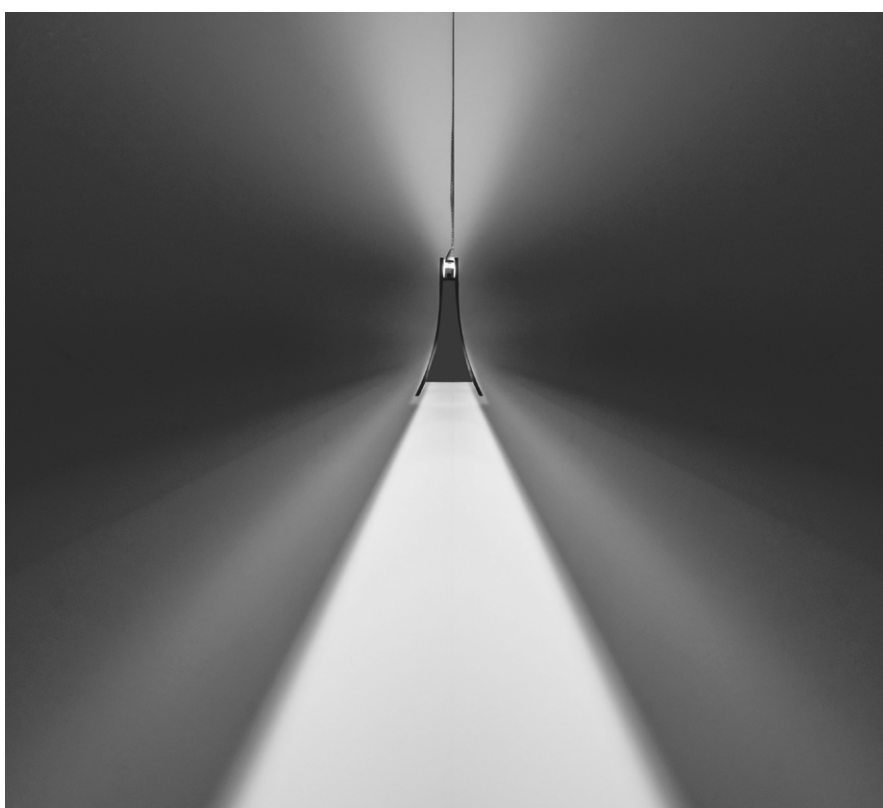





Iluminación Up&Down  
Iluminação Up&Down

Bravo

BODY MAT	DIF MAT
AL	ACR

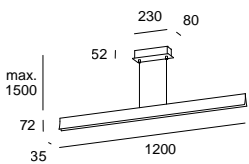

LED | K 3000 | CRI 80 | Real Lm 3075

Oro Ouro F5   
Blanco opal Branco opalino M1

	W Total	Structure	Difussor	Code
ON-OFF 110-240V	40.7	F5 <input checked="" type="radio"/>	M1 <input type="radio"/>	<b>00-4925-F5-M1</b> <b>QS</b>
PHASE CUT 220-240V	42.2	F5 <input checked="" type="radio"/>	M1 <input type="radio"/>	<b>00-4926-F5-M1</b>

# Bol



## Performance Universe



P. 348



### Bol Ø450mm

BODY MAT	DIF MAT	
ST	ACR,TEX	

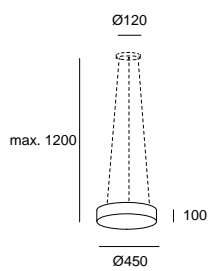

LED | K 3000 | CRI 80 | W Total 23 | Real Lm 1064

Arena Areia BY   
Blanco opal Branco opalino M1

	Body	Difussor	Code
ON-OFF 100-240V	BY <input checked="" type="radio"/>	M1 <input type="radio"/>	<b>15-4922-BY-M1</b>

### Bol Ø750mm

BODY MAT	DIF MAT	
ST	ACR,TEX	

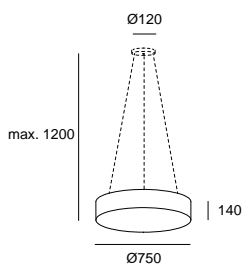

LED | K 3000 | CRI 80 | W Total 33 | Real Lm 1646

Arena Areia BY   
Blanco opal Branco opalino M1

	Body	Difussor	Code
ON-OFF 100-240V	BY <input checked="" type="radio"/>	M1 <input type="radio"/>	<b>15-A052-BY-M1</b>

No incluidos y requeridos  
Não incluído e requeridos

Kit suspensión  
Kit suspensão

71-4695-81-81

# Lectura

## Leitura



Invisible

184



Perlina

182



Chic

186



E-lamp

188

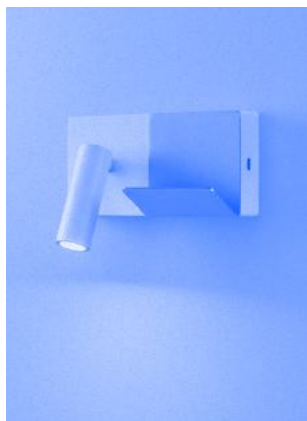

**E-lamp Mini 190**



**Hall Slim 191**

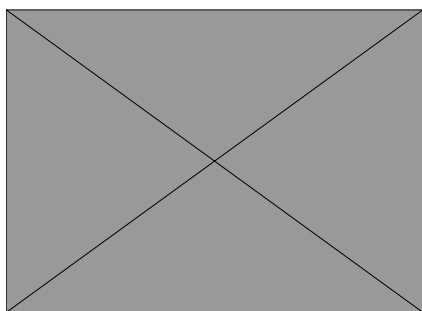

**Gamma 192**

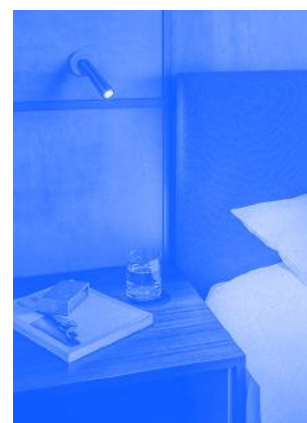

**Gamma Mini 193**



**Gamma Extend 194**



**Radar**

**195**



**Simply**

**197**

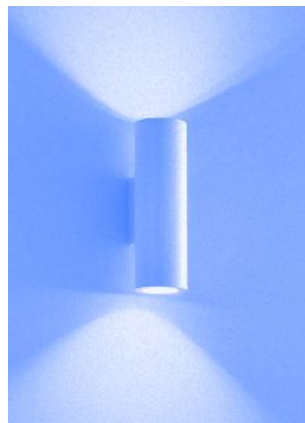

**Pipe**

**196**



**Stylus**

**198**



**Bed**

**199**



Link

200



Tip

201



Clip

202



Metrica

204

# Perlina



## Performance Universe



P. 220



P. 254



P. 276



P. 358



### Joya natural

Perlina se inspira en una joya natural para ofrecer una perla iluminada que juega con la esencia de la circunferencia, redonda y perfecta, dando sentido al minimalismo de lo básico. Cuando está encendida, su efecto de luz tamizada transmite un sentimiento de calma llenando el espacio con naturalidad y acomodándose a él gracias a la posibilidad de regulación manual mediante dimmer.

### Joia natural

Perlina inspira-se numa joia natural para oferecer uma pérola iluminada que brinca com a essência da circunferência, redonda e perfeita, dando sentido ao minimalismo do básico. Quando acesa, o seu efeito de luz filtrada transmite uma sensação de calma, preenchendo naturalmente o espaço e adaptando-se a ele graças à possibilidade de regulação manual através de dimmer.



**Perlina USB**

QS

BODY MAT	DIF MAT		SWITCH CCT	
AISI304	GLA		2700-3000-4000	DIM

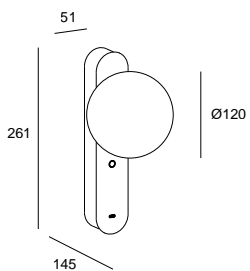

**LED | K 2700-3000-4000 | CRI 90 | W Total 8.8 | Real Lm 391 (3000K)**

Negro Preto 60 ●  
Oro mate Ouro mate DN ●



**Structure Code**

TOUCH DIMMING 220-240V

60 ● **05-A078-60-60**  
DN ● **05-A078-DN-DN**

QS Quick Service | 2-6 días laborables (tiempo de transporte no incluido)  
Quick Service | 2-6 dias úteis (tempo de transporte não incluido)

# Invisible



## Performance Universe



P. 151



P. 226



P. 262

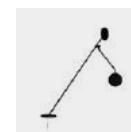

P. 292



### Movimiento en equilibrio

Francesc Vilaró se ha inspirado en los móviles del escultor Alexander Calder para diseñar la colección, buscando el equilibrio entre las líneas que forman la estructura y su contrapeso. En esta composición de balances, la luz puede dirigirse a cualquier punto, proyectando una luz de acento de forma muy honesta, con una gran libertad de movimientos.

### Movimento em equilíbrio

Francesc Vilaró inspirou-se nos móveis do escultor Alexander Calder para criar a coleção, procurando um equilíbrio entre as linhas que formam a estrutura e o seu contrapeso. Nesta composição de equilíbrios, a luz pode ser dirigida para qualquer ponto, projetando uma luz de realce de uma forma muito honesta, com uma grande liberdade de movimentos.



La rotación del cabezal permite dirigir la luz.

A rotação da cabeça permite dirigir a luz.

### Invisible Reader Small

QS

BODY MAT	DIF MAT					
ST,AL	PMMA		180°	0° - 90°		DIM

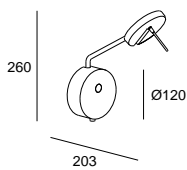

LED | CRI 90 | W Total 10,5

Negro Preto 05 ●

	K	Real Lm	Structure	Code
TOUCH DIMMING	2700	534	05 ●	<b>05-7382-05-05</b>
100-240V	3000	550	05 ●	<b>05-7380-05-05</b>

### Invisible Reader Large

QS

BODY MAT	DIF MAT					
ST,AL	PMMA		180°	0° - 90°		DIM

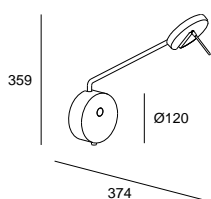

LED | CRI 90 | W Total 10,5

Negro Preto 05 ●

	K	Real Lm	Structure	Code
TOUCH DIMMING	2700	534	05 ●	<b>05-7383-05-05</b>
100-240V	3000	550	05 ●	<b>05-7381-05-05</b>

# Chic



## Performance Universe



### Calidad en la mínima expresión

Aplique de lectura de tamaño muy compacto con un elevado componente técnico. Gracias a su desarrollo y al confort visual obtenido, Chic cumple su funcionalidad sin renunciar al diseño y al factor decorativo.

### Qualidade na mínima expressão

Aplique de leitura em tamanho muito compacto com uma elevada componente técnica. Graças ao seu desenvolvimento e ao conforto visual obtido, Chic cumpre a sua funcionalidade sem renunciar ao design e ao fator decorativo.



Incluye panel de abeja para mayor confort visual.

Inclui um painel de abelha para maior conforto visual.

**Chic**

BODY MAT	DIF MAT					
AL	PMMA		360°	90°		DIM

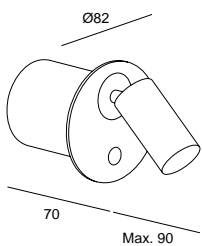

**LED | K 2700 | CRI 90 | W Total 3.9 | Real Lm 200**

- Blanco Branco 14 ○
- Negro Preto 05 ●
- Oro mate Ouro mate DN ●



TOUCH DIMMING 100-240V

Structure	Code
05 ●	<b>05-8509-05-05</b>
14 ○	<b>05-8509-14-14</b>
DN ●	<b>05-8509-DN-DN</b>

60 10 mm

# E-lamp



Performance Universe



P. 190



## Multifuncional

E-lamp es una colección de diseño racional y simple, basado en formas geométricas básicas. Esta familia multifuncional de luminarias busca la armonía e integración en el espacio. Centrada en el teléfono móvil, incluye USB en todas sus versiones y tecnología Wireless Charging en la opción sobremesa.

## Multifuncional

E-lamp é uma coleção de design racional e simples, baseada em formas geométricas básicas. Esta família no espaço. Centrada no telemóvel, inclui USB em todas as suas versões e tecnologia Wireless Charging na opção de mesa.



Opción de botones dorados en los dos acabados.  
Opção de botões dourados em ambos os acabamentos.

Carga de aparatos electrónicos mediante USB.

Carrega dispositivos eletrônicos via USB.

## E-lamp

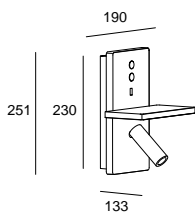
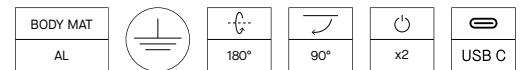

**LED+LED | K 2700 | CRI 80 | W Total 12.3 | Real Lm 469**



ON-OFF 220-240V

**Structure Button Code**

05 ●	05 ●	<b>05-7606-05-05</b> QS
05 ●	DO ●	<b>05-7606-05-DO</b>
14 ○	14 ○	<b>05-7606-14-14</b> QS
14 ○	DO ●	<b>05-7606-14-DO</b>

Blanco Branco 14 ○

Negro Preto 05 ●

Latón pulido Latão polido DO ●

# E-lamp Mini



## Performance Universe



P. 188



Posibilidad de instalación vertical u horizontal.  
Possibilidade de instalação vertical e horizontal.



Carga de aparatos electrónicos mediante USB.  
Carrega dispositivos eletrónicos via USB.

## E-lamp Mini

QS

BODY MAT					
AL		180	90°		USB C

Blanco Branco	14		Oro mate Ouro mate	DN	
Negro Preto	05		Blanco brillante Branco brilhante	EU	
Níquel satinado Níquel acetinado	81		Negro brillante Preto brilhante	EV	

LED | K 2700 | CRI 90 | W Total 3.2 | Real Lm 137

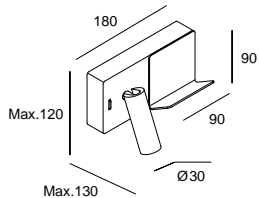

Structure	Body	Code
05	81	<b>05-8329-05-81</b>
05	DN	<b>05-8329-05-DN</b>
05	EV	<b>05-8329-05-EV</b>
14	81	<b>05-8329-14-81</b>
14	DN	<b>05-8329-14-DN</b>
14	EU	<b>05-8329-14-EU</b>

ON-OFF 100-240V



QS Quick Service | 2-6 días laborables (tiempo de transporte no incluido)  
Quick Service | 2-6 dias úteis (tempo de transporte não incluído)

# Hall Slim



Performance Universe



## Elegancia discreta

Hall Slim es una colección con un perfil compacto y rectilíneo que se presenta con distintos acabados que permiten integrar una luz de lectura orientable de manera discreta.

## Elegância discreta

Hall Slim é uma coleção com um perfil compacto e retilíneo que se apresenta em diferentes acabamentos que permitem integrar uma luz de leitura orientável de forma discreta.



## Hall Reader

QS

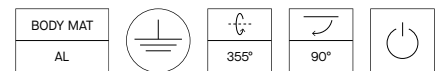

Blanco Branco 14 ○  
 Negro Preto 05 ●  
 Oro mate Ouro mate DN ●

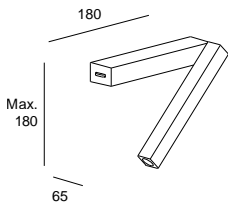

LED | K 2700 | CRI 90 | W Total 3.5 | Real Lm 150



ON-OFF 100-240V

Structure

Code

05 ●	<b>05-8510-05-05</b>
14 ○	<b>05-8510-14-14</b>
DN ●	<b>05-8510-DN-DN</b>



QS Quick Service | 2-6 días laborables (tiempo de transporte no incluido)  
 Quick Service | 2-6 dias úteis (tempo de transporte não incluído)

# Gamma



## Performance Universe



P. 194



P. 228



P. 264



Posibilidad de instalación empotrado o superficie.  
Possibilidade de instalação encastrada ou superfície.

### Gamma Round

QS

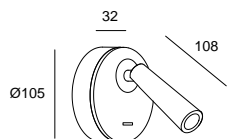
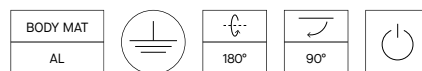

LED | K 2700 | CRI 90 | W Total 3.5 | Real Lm 137



Structure Code

Blanco Branco 14 ○  
Negro Preto 05 ●  
Níquel satinado Níquel acetinado 81 ●  
Oro mate Ouro mate DN ●

ON-OFF 100-277V

05 ● **05-6421-05-05**  
14 ○ **05-6421-14-14**  
81 ● **05-6421-81-81**  
DN ● **05-6421-DN-DN**

96 3-35 mm

### Gamma Square

QS

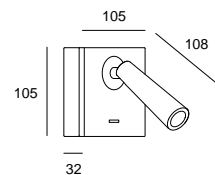
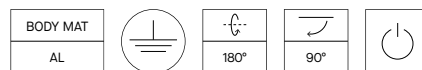

LED | K 2700 | CRI 90 | W Total 3.5 | Real Lm 137



Structure Code

Blanco Branco 14 ○  
Negro Preto 05 ●  
Níquel satinado Níquel acetinado 81 ●  
Oro mate Ouro mate DN ●

ON-OFF 100-277V

05 ● **05-6420-05-05**  
14 ○ **05-6420-14-14**  
81 ● **05-6420-81-81**  
DN ● **05-6420-DN-DN**

3-35 mm 96

# Gamma Mini



Performance Universe



P. 194



P. 228



P. 264



## Gamma Mini

QS

BODY MAT			
AL		180	90

- Blanco Branco 14
- Negro Preto 05
- Níquel satinado Níquel acetinado 81
- Oro mate Ouro mate DN

LED | K 2700 | CRI 90 | W Total 3.6 | Real Lm 137

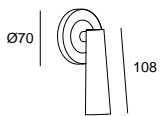

40 3-30 mm



ON-OFF 100-240V

Structure Code

- 05 **05-6428-05-05**
- 14 **05-6428-14-14**
- 81 **05-6428-81-81**
- DN **05-6428-DN-DN**

# Gamma Extend



Performance Universe

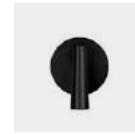

P. 192



P. 228



P. 264



## Elegancia y precisión

Gamma Extend conserva toda la esencia de la colección, presentando una silueta moldeada con precisión con un acabado perfecto en todas sus variantes.

## Elegância e precisão

Gamma Extend conserva toda a essência da coleção, apresentando uma silhueta moldada com precisão com um acabamento perfeito em todas as suas variantes.

## Gamma Extend

QS

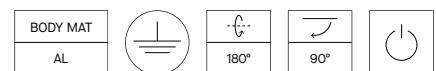

Blanco Branco 14 ○  
 Negro Preto 05 ●  
 Níquel satinado Níquel acetinado 81 ○  
 Oro mate Ouro mate DN ○

LED | K 2700 | CRI 90 | W Total 3.2 | Real Lm 137



Structure

Code

05 ● 05-8339-05-05  
 14 ○ 05-8339-14-14  
 81 ○ 05-8339-81-81  
 DN ○ 05-8339-DN-DN

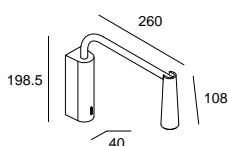

ON-OFF 100-240V

# Radar



## Performance Universe



Radar combina un excelente punto de luz orientable con un diseño minimalista fácilmente integrable en distintos ambientes.

Radar combina um excelente ponto de luz orientável com um design minimalista que pode ser facilmente integrado em diferentes ambientes.



Radar dispone de LCA (Life Cycle Assessment).  
O Radar dispõe de LCA (Life Cycle Assessment).

### Radar

QS

BODY MAT	DIF MAT		
AL	PMMA		360°

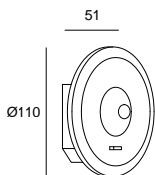

LED | K 3000 | CRI 80 | W Total 6 | Real Lm 150

Blanco Branco 14   
Negro Preto 60



Structure

Code

ON-OFF 100-240V

14   
60

**05-6488-14-14**  
**05-6488-60-60**

85 3-30 mm

# Pipe



## Essential Universe



P. 170



P. 354

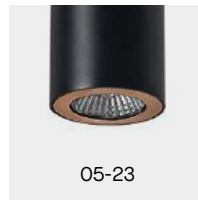

05-23



14-05

Combinaciones standard.  
Combinações padrão.



14-14



05-05

Posibilidad de otras combinaciones mediante aros no incluidos.  
Possibilidade de outras combinações por aros não incluídos.

## Pipe Reader

QS

BODY MAT  
ST,AL



Blanco Branco 14 ○  
Negro Preto 05 ●

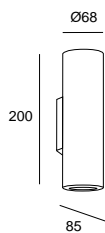

GU10 | W 2 × Max. 8

Structure Ring

14 ○      05 ●  
05 ●\*     05 ●\*

\*Bombilla no incluída.  
\*Lâmpada não incluída.

Code

05-2759-14-05  
05-2759-05-05

Acc. comunes no incluídos

Aro branco  
Aro branco

71-0073-14-14

Ac. comuns não incluídos

Aro negro  
Aro preto

71-0073-05-05

\*Consulte condiciones y plazos de entrega a nuestro equipo comercial.

\*Consultar a nossa equipa comercial para informações sobre as condições e os prazos de entrega.

# Simply



## Essential Universe



P. 230



P. 353



### Efectividad en la mínima expresión

Simply ofrece una máxima funcionalidad con la mínima expresión. Esta serie está concebida para perdurar en el tiempo e iluminar cualquier estancia, independientemente de cuál sea su estilo.

### Efectividade na mínima expressão

Simply oferece a máxima funcionalidade com a mínima expressão. Esta série foi concebida para perdurar no tempo e iluminar qualquer divisão, independentemente de qual seja o seu estilo.

## Simply

QS

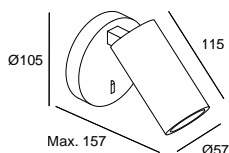
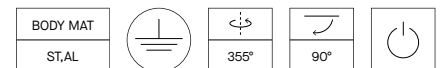

GU10 | W Max. 8

### Structure

05 ●  
14 ○

\*Bombilla no incluida.  
\*Lâmpada não incluida.

### Code

05-7982-05-05  
05-7982-14-14

Blanco Branco 14 ○  
Negro Preto 05 ●

# Stylus



Essential Universe



P. 172



P. 355



Stylus dispone de LCA (Life Cycle Assessment).  
O Stylus dispõe de LCA (Life Cycle Assessment).

## Stylus Switch

BODY MAT	DIF MAT				
AL	PC		355°	0° a 90°	

LED | K 3000 | CRI 90 | W Total 4.5 | Real Lm 276

Blanco Branco 14 ○  
Negro Preto 05 ●



ON-OFF 100-240V

Structure

Code

05 ●  
14 ○

05-6193-05-05  
05-6193-14-14



# Bed

## Essential Universe



### Bed Round

QS

BODY MAT		
AL		

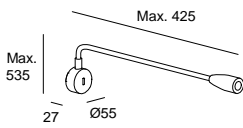

LED | K 3000 | CRI 90 | W Total 3.5 | Real Lm 115

Negro Preto 05 ●



Structure

Code

ON-OFF 100-240V

05 ●

05-2830-05-05

### Bed Rectangular

QS

BODY MAT		
AL		

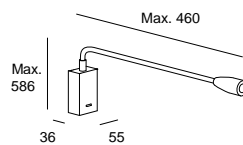

LED | K 3000 | CRI 90 | W Total 3.5 | Real Lm 115

Negro Preto 05 ●



Structure

Code

ON-OFF 100-240V

05 ●

05-2831-05-05

# Link



## Performance Universe



Opción Touch dimming en el cabezal.  
Opção Touch dimming na cabeça.

Un mismo modelo con dos opciones de instalación.  
O mesmo modelo com duas opções de instalação.

### Link Surface

QS

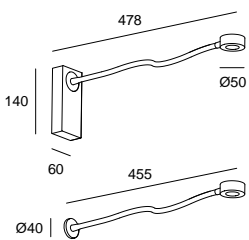

LED | K 2700 | CRI 80 | W Total 4 | Real Lm 121

Blanco Branco 14 ○  
Negro Preto 05 ●

Structure	Code
TOUCH DIMMING 100-240V	
05 ●	<b>05-7366-05-05</b>
14 ○	<b>05-7366-14-14</b>

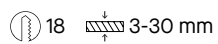

### Link Recessed

QS

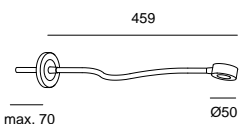
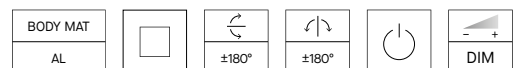

LED | K 2700 | CRI 80 | W Total 4 | Real Lm 121

Blanco Branco 14 ○  
Negro Preto 05 ●

Structure	Code
TOUCH DIMMING 100-240V	
05 ●	<b>05-7367-05-05</b>
14 ○	<b>05-7367-14-14</b>

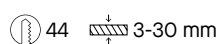

# Tip



## Performance Universe



### Tip

QS

BODY MAT					
AL		±180°	±180°		DIM

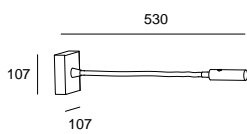

LED | K 3000 | CRI 92 | W Total 4.2 | Real Lm 175

Níquel satinado Níquel acetinado 81   
 Oro mate Ouro mate DN



TOUCH DIMMING 100-240V

Structure Code

81 05-5296-81-81  
 DN 05-5296-DN-DN

# Clip



## Essential Universe



P. 234



P. 268



### Estilo y pureza

Clip es la reinención de un clásico, su leve inclinación aporta un toque fresco al diseño jugando con un punto LED completamente integrado. Es una luminaria funcional gracias a la combinación de pantalla y punto de lectura independiente.

### Estilo e pureza

Clip é a reinvenção de um clássico, a sua ligeira inclinação dá um toque de frescura ao design, jogando com um ponto LED completamente integrado. É uma luminária funcional graças à combinação de quebra-luz e ponto de leitura independente.



El lector LED permite una rotación muy amplia para mayor comodidad.

O leitor LED permite uma rotação muito ampla para maior conforto.

## Clip

QS

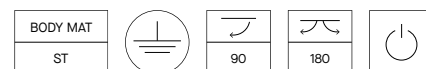

Negro Preto 05 ●

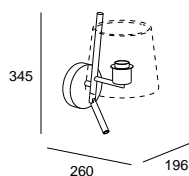

LED+E27 | K 2700 | CRI 92 | Real Lm 53

		W Total	Structure	Code
ON-OFF 100-277V	LED E27	2.2 15	05 ●	<b>05-8540-05-82</b>

\*Bombilla no incluida.  
\*Lâmpada não incluída.

Acc. comunes no incluidos y requeridos

Ac. comuns não incluído e requeridos



14 ○  
05 ●

**PAN-232-14**

**PAN-232-05**

# Metrica



## Essential Universe



P. 236



P. 270



P. 313



### Un clásico con múltiples opciones

Metrica es una solución perfecta gracias a sus múltiples posibilidades de luz de pantalla, punto de lectura y flexo. Con un diseño actual y sobrio es una colección altamente versátil.

### Um clássico com várias opções

Metrica é uma solução perfeita graças às suas múltiplas possibilidades de quebra-luz, ponto de leitura e braço articulado. Com um design atual e sóbrio, é uma coleção muito versátil.



**Metrica Shade Reader**

QS

BODY MAT ST,AL	DIF MAT TEX		 180	 90°	 x2
-------------------	----------------	--	---------	---------	--------

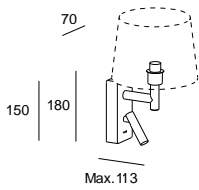

**LED+E27 | K 2700 | CRI 92 | Real Lm 137**

Negro Preto 05 ●  
Níquel satinado Níquel acetinado 81 ●

		W Total	Structure	Code
ON-OFF 100-240V	LED E27	2.1 15	05 ● 81 ●	<b>05-8400-05-82</b> <b>05-8400-81-82</b>

\*Bombilla no incluida.  
\*Lâmpada não incluida.

QS Quick Service | 2-6 días laborables (tiempo de transporte no incluido)  
Quick Service | 2-6 dias úteis (tempo de transporte não incluido)



## Metrica Extended

QS

BODY MAT	DIF MAT				
ST,AL	TEX	180	90°	x2	

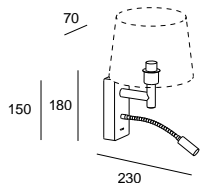

LED+E27 | K 2700 | CRI 92 | Real Lm 137

Negro Preto 05 ●  
Níquel satinado Níquel acetinado 81 ●

	W Total	Structure	Code
ON-OFF 100-240V	LED E27	2.1 15	05 ● 81 ●
			<b>05-8401-05-82</b> <b>05-8401-81-82</b>

\*Bombilla no incluída.  
\*Lâmpada não incluída.

QS Quick Service | 2-6 días laborables (tempo de transporte no incluído)  
Quick Service | 2-6 días úteis (tempo de transporte não incluído)

## No incluídos y requeridos Não incluído e requeridos

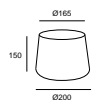

14 ○  
05 ●  
BY ●

**PAN-157-14**  
**PAN-157-05**  
**PAN-157-BY**

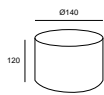

14 ○  
BY ●

**PAN-175-14**  
**PAN-175-BY**

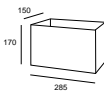

14 ○  
BY ●

**PAN-176-14**  
**PAN-176-BY**

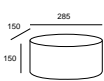

14 ○  
BY ●

**PAN-177-14**  
**PAN-177-BY**

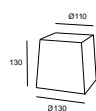

14 ○  
BY ●

**PAN-178-14**  
**PAN-178-BY**

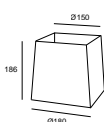

14 ○  
BY ●

**PAN-179-14**  
**PAN-179-BY**



# Sobremesa

## De mesa



Dara

210

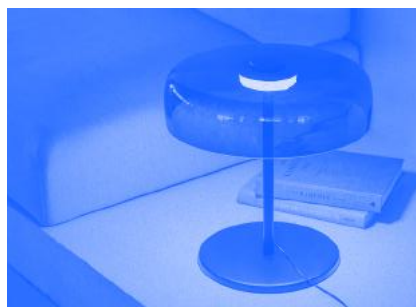

Levels

212



llargi

218

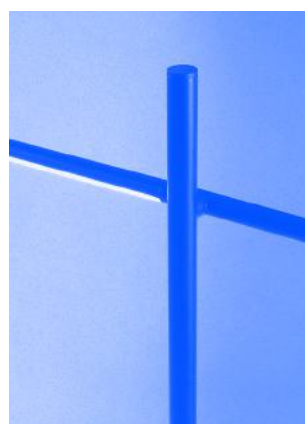

Tubs

222



H

216



Perlina

220



Maca

224



Invisible

226



Gamma

228



Organic

229



Simply

230



Nude

231



Clip

234



Metrica

236

# Dara NEW



Essential Universe



## Simplicidad, funcionalidad y versatilidad

Dara destaca por su originalidad y minimalismo, ofreciendo una iluminación general cuando se coloca en posición vertical y una luz más focalizada al inclinarla. Gracias a un simple gesto en la base, permite ajustarse fácilmente a dos posiciones: una pensada para crear una luz ambiente suave y otra ideal para trabajar o leer con mayor precisión.

## Simplicidade, funcionalidade e versatilidade

Dara distingue-se pela sua originalidade e minimalismo, oferecendo uma iluminação geral quando colocada na vertical e uma luz mais focada quando inclinada. Graças a um simples gesto na base, pode ser facilmente ajustada em duas posições: uma pensada para criar uma luz ambiente suave e outra ideal para trabalhar ou ler com maior precisão.





Base metálica con un corte frontal que facilita la inclinación de la lámpara para obtener una iluminación más focalizada si se desea.

Diseño esencial en dos elementos —parte lumínica y base— con un corte frontal que permite inclinar la lámpara para obtener luz focal.

Base metálica com um corte frontal que facilita a inclinação da lâmpada para obter uma iluminação mais focada, se desejado.

Design essencial em dois elementos – parte lumínica e base – com um corte frontal que permite inclinar o candeeiro para obter luz focal.

Cabezal de líneas depuradas y difusor de diseño preciso, que garantizan una estética elegante y un acabado de alta calidad.

Un gesto simple que la distingue, con un cabezal depurado y un difusor elegante que aportan versatilidad y carácter.

Cabeça de linhas depuradas e um difusor de design preciso garantem uma estética elegante e um acabamento de alta qualidade.

Um gesto simples que a distingue, com uma cabeça depurada e um difusor elegante que conferem versatilidade e carácter.



## Dara

QS

BODY MAT	DIF MAT		
ST: AL	PMMA		45°

Negro Preto 05 ●  
Arena Areia FF ●

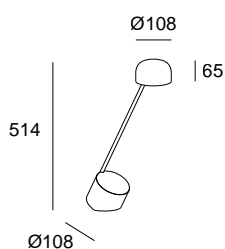

LED | K SW 2700-3000 | CRI 92 | W Total 10.2 | Real Lm 506 (3000K)



ON-OFF 220-240V

### Structure

### Code

05 ●  
FF ●

10-A009-05-05

10-A009-FF-FF

# Levels



## Performance Universe



P. 086

P. 250

P. 328



### Convivencia natural con el entorno

Cada espacio requiere un lenguaje concreto, marcado por la personalidad del ambiente. Las distintas formas y transparencias de las pantallas de Levels sobremesa buscan una convivencia natural con su entorno integrándose tanto a nivel de acabado como de efecto de luz gracias a la transparencia de su vidrio soplado de forma artesanal

### Convivência natural com o meio ambiente

Cada espaço requer uma linguagem específica, marcada pela personalidade do ambiente. As diferentes formas e transparências do as quebra-luces de Levels de mesa procuram uma coexistência natural com o seu ambiente, integrando-se tanto em termos de acabamento como de efeito de luz graças à transparência do seu vidro soprado de forma artesanal.





## Levels 1 Body Ø220mm

QS

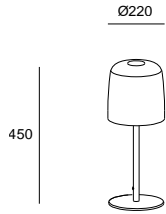

BODY MAT	DIF MAT	SWITCH CCT	2700-3000-4000
ST	GLA		

Negro Preto	05	●
Verde Verde	08	●
Fumé Fumado	12	●
Ámbar Âmbar	15	●

LED | K 2700-3000-4000 | CRI 92 | W Total 14.7 | Real Lm 1069 (3000K)

	Structure	Difussor	Code
3 STEPS DIMMING 100-240V	05 ●	08 ●	<b>10-A002-05-08</b>
	05 ●	12 ●	<b>10-A002-05-12</b>
	05 ●	15 ●	<b>10-A002-05-15</b>

## Levels 1 Body Ø320mm

QS

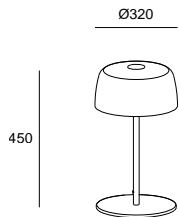

BODY MAT	DIF MAT	SWITCH CCT	2700-3000-4000
ST	GLA		

Negro Preto	05	●
Verde Verde	08	●
Fumé Fumado	12	●
Ámbar Âmbar	15	●

LED | K 2700-3000-4000 | CRI 92 | W Total 14.7 | Real Lm 1069 (3000K)

	Structure	Difussor	Code
3 STEPS DIMMING 100-240V	05 ●	08 ●	<b>10-A003-05-08</b>
	05 ●	12 ●	<b>10-A003-05-12</b>
	05 ●	15 ●	<b>10-A003-05-15</b>

## Levels 1 Body Ø420mm

QS

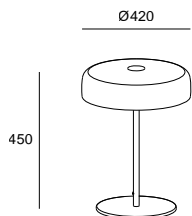

BODY MAT	DIF MAT	SWITCH CCT	2700-3000-4000
ST	GLA		

Negro Preto	05	●
Verde Verde	08	●
Fumé Fumado	12	●
Ámbar Âmbar	15	●

LED | K 2700-3000-4000 | CRI 92 | W Total 14.7 | Real Lm 1069 (3000K)

	Structure	Difussor	Code
3 STEPS DIMMING 100-240V	05 ●	08 ●	<b>10-A004-05-08</b>
	05 ●	12 ●	<b>10-A004-05-12</b>
	05 ●	15 ●	<b>10-A004-05-15</b>

## Levels Table Lamps 2 Bodies

QS

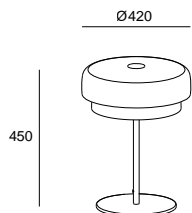

BODY MAT	DIF MAT	SWITCH CCT	2700-3000-4000
ST	GLA		

Negro Preto	05	●
Verde Verde	08	●
Fumé Fumado	12	●
Ámbar Âmbar	15	●

LED | K 2700-3000-4000 | CRI 92 | W Total 14.7 | Real Lm 1069 (3000K)

	Structure	Difussor	Code
3 STEPS DIMMING 100-240V	05 ●	08 ●	<b>10-A005-05-08</b>
	05 ●	12 ●	<b>10-A005-05-12</b>
	05 ●	15 ●	<b>10-A005-05-15</b>

Los acabados y tonalidad mostrados pueden no ser completamente precisos debido a ligeras variaciones en la producción, factores de iluminación fotográficas e impresión.

Os acabamentos e tonalidades apresentados podem não ser totalmente precisos, devido a ligeiras variações na produção, fatores de iluminação fotográfica e de impressão.

# H



## Performance Universe



P. 140



P. 258



P. 306



### Elegancia innata

La colección de luminarias H nace como una reinterpretación contemporánea del clásico sobremesa de pantalla cónica. La versatilidad de la colección permite iluminar diferentes espacios de forma delicada, mediante piezas que aportan un gran valor representativo.

### Elegância inata

A coleção de luminárias H nasce como uma reinterpretação contemporânea do clássico de mesa de quebra-luz cônico. A versatilidade da coleção permite iluminar diferentes espaços de forma delicada, mediante peças que proporcionam um grande valor representativo.

H

QS

BODY MAT
ST

DIF MAT
ACR

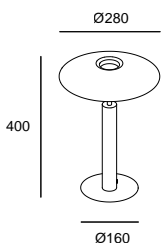

LED | K 2700 | CRI 92 | W Total 16.3 | Real Lm 627

 ON-OFF 220-240V

Structure

05 ●  
DN ●

Code

10-7742-05-05  
10-7742-DN-DN

Negro Preto 05 ●  
Oro mate Ouro mate DN ●



# Ilargi



## Performance Universe



P. 092



Base de madera maciza con acabado en fresno o negro y difusor de cristal opal.  
Base de madeira maciça com acabamento em freixo ou preto e difusor de vidro opalino.

## La calidez de un diseño atemporal

Ilargi, creada por los diseñadores vascos Irtzoki y Lizaso, es una combinación perfecta de calidez y diseño funcional atemporal. Su cristal de vidrio soplado de manera artesanal tiene una presencia muy elegante, que se combina con madera noble maciza. Su luz es suave y agradable, perfecta para uso residencial o para espacios públicos creando ambientes confortables y naturales.

## A calidez de um design intemporal

Ilargi, criada pelos designers bascos Irtzoki e Lizaso, é uma combinação perfeita de calidez e design funcional intemporal. A sua campânula de vidro soprado de forma artesanal tem uma presença muito elegante, que é combinada com a madeira nobre maciça. A sua luz é suave e agradável, perfeita para uso residencial ou para espaços públicos criando ambientes confortáveis e naturais.



Con Touch Dimming.  
Com Touch Dimming.

### Ilargi Ø230

BODY MAT	DIF MAT		
WOOD	GLA		

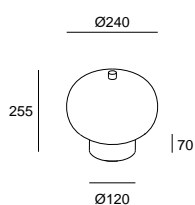

LED | K 2700 | CRI 92 | W Total 10.5 | Real Lm 641

Fresno oscuro Cinza escura 92 ●  
Fresno claro Cinza claro 93 ●  
Arenado Areado F9 ○

	Structure	Difussor	Code
TOUCH DIMMING 100-240V	92 ● 93 ●	F9 ○ F9 ○	<b>10-6010-92-F9</b> <b>10-6010-93-F9</b>

### Ilargi Ø320

BODY MAT	DIF MAT		
WOOD	GLA		

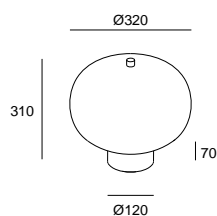

LED | K 2700 | CRI 92 | W Total 16.4 | Real Lm 1054

Fresno oscuro Cinza escura 92 ●  
Fresno claro Cinza claro 93 ●  
Arenado Areado F9 ○

	Structure	Difussor	Code
TOUCH DIMMING 100-240V	92 ● 93 ●	F9 ○ F9 ○	<b>10-6011-92-F9</b> <b>10-6011-93-F9</b>

# Perlina



## Performance Universe



### Joya natural

Este sobremesa juega con una doble función, por un lado, el de la practicidad de una luminaria práctica con una luz difusa muy agradable y por el otro, como un objeto de decoración delicado y elegante que puede integrarse fácilmente en cualquier ambiente. Además, Perlina permite crear diferentes ambientes gracias a su regulación dimable.

### Joia natural

Este candeeiro de mesa tem uma função dupla: por um lado, a praticidade de uma luminária prática com uma luz difusa muito agradável e, por outro lado, como um objeto decorativo delicado e elegante que pode ser facilmente integrado em qualquer ambiente. Além disso, Perlina permite criar diferentes ambientes graças à sua regulação dimmable.

## Perlina

QS

BODY MAT AISI304	DIF MAT GLA		SWITCH CCT 2700-3000-4000		USB C
---------------------	----------------	--	------------------------------	--	-------

Negro Preto 60 ●  
Oro mate Ouro mate DN ●

LED | K 2700-3000-4000 | CRI 92 | W Total 8.8 | Real Lm 391 (3000K)



TOUCH DIMMING 220-240V

Structure Code

60 ● 10-A078-60-60  
DN ● 10-A078-DN-DN

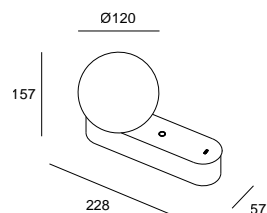



# Tubs



## Performance Universe



P. 260



P. 289



## Presencia y dinamismo

Tubs es un sobremesa con una fuente de luz en forma lineal que tiene una amplia capacidad de movimientos, lo que ofrece un gran dinamismo a la pieza y dota de carácter el espacio que habita. Sofisticada y elegante, con una base en mármol negro, puede regularse mediante touch dimming, adaptándose a las necesidades lumínicas de cada momento.

## Presença e dinamismo

Tubs é uma versão de mesa com uma fonte de luz em forma linear que possui uma ampla capacidade de movimento, oferecendo um grande dinamismo à peça e conferindo caráter ao espaço que habita. Sofisticada e elegante, com uma base em mármore preto, pode ser regulada mediante touch dimming, adaptando-se às necessidades lumínicas de cada momento.



Base en mármol.  
Base de mármore.



Con Touch Dimming.  
Com Touch Dimming.

## Tubs

QS

BODY MAT	DIF MAT			
ST.AL,MAR	PC			

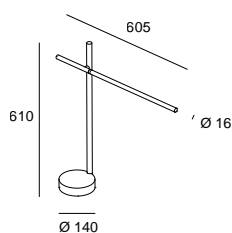

LED | CRI 92 | W Total 9.5

Negro Preto 05 ●  
Blanco opal Branco opalino M1 ○

	K	Real Lm	Structure	Difusor	Code
TOUCH DIMMING 220-240V	2700 3000	479 504	05 ● 05 ●	M1 ○ M1 ○	<b>10-A026-05-M1</b> <b>10-8102-05-M1</b>

# Maca



Performance Universe



## Funcionalidad y comodidad

Maca ha sido creada como una herramienta de trabajo confortable tanto en su forma, de mecánica y tacto suave, como en su función, ya que proporciona una luz asimétrica con unas prestaciones técnicas muy elevadas, con un buen pack lumínico y opción de 3 temperaturas de color dimables a través de un único botón touch.

## Funcionalidade e comodidade

Maca foi criada como uma ferramenta de trabalho confortável, tanto na sua forma, de mecânica e toque suave, como na sua função, já que proporciona uma luz assimétrica com um desempenho técnico muito elevado, com um bom pack lumínico e opção de 3 temperaturas de cor reguláveis através de um único botão touch.



## Maca

QS

BODY MAT	DIF MAT		SWITCH CCT		
ST	ACR		2700-3000-4000	355°	90°

Blanco texturizado Branco texturizado  DQ   
 Negro texturizado Preto texturizado  DI

LED | K 2700-3000-4000 | CRI 80 | W Total 9 | Real Lm 587 (3000K)



Structure

Code

TOUCH DIMMING 220-240V

DI   
 DQ

**10-9055-DI-DI**  
**10-9055-DQ-DQ**

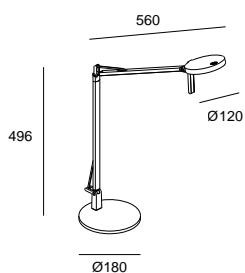

# Invisible



## Performance Universe



P. 151



P. 184



P. 262

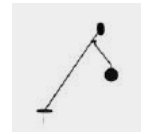

P. 292



### Movimiento en equilibrio

Francesc Vilaró se ha inspirado en los móviles del escultor Alexander Calder para diseñar la colección, buscando el equilibrio entre las líneas que forman la estructura y su contrapeso. En esta composición de balances, la luz puede dirigirse a cualquier punto, proyectando una luz de acento de forma muy honesta, con una gran libertad de movimientos.

### Movimento em equilíbrio

Francesc Vilaró inspirou-se nos móveis do escultor Alexander Calder para criar a coleção, procurando um equilíbrio entre as linhas que formam a estrutura e o seu contrapeso. Nesta composição de equilíbrios, a luz pode ser dirigida para qualquer ponto, projetando uma luz de realce de uma forma muito honesta, com uma grande liberdade de movimentos.



La rotación del cabezal permite dirigir la luz.  
A rotação da cabeça permite dirigir a luz.

## Invisible

QS

BODY MAT	DIF MAT					
ST,AL	PMMA		355°	355°	±90°	

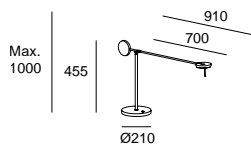

LED | CRI 92

Negro Preto 05 ●

	K	W Total	Real Lm	Structure	Code
TOUCH DIMMING	2700		496	05 ●	10-7385-05-05
100-240V	3000		550	05 ●	10-5693-05-05

# Gamma



## Performance Universe

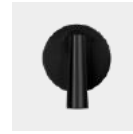

P. 192



P. 194



P. 264



### Diseño minimalista contemporáneo

Con un diseño contemporáneo y minimalista, Gamma es una solución de luz para escritorio con cualidades técnicas y decorativas que la convierten en una opción siempre acertada.

### Design minimalista contemporâneo

Com um design contemporâneo e minimalista, Gama é uma solução de iluminação de secretária com qualidades técnicas e decorativas que a tornam uma excelente escolha.

Botón de encendido en la base.  
Botão de ligar/desligar na base.



## Gamma

QS



- Blanco Branco 14 ○
- Negro Preto 05 ●
- Níquel satinado Níquel acetinado 81 ○
- Oro mate Ouro mate DN ●

LED | K 2700 | CRI 92 | W Total 4.3 | Real Lm 293



ON-OFF 100-240V

Structure

Code

- |      |                      |
|------|----------------------|
| 05 ● | <b>10-6420-05-05</b> |
| 14 ○ | <b>10-6420-14-14</b> |
| 81 ○ | <b>10-6420-81-81</b> |
| DN ● | <b>10-6420-DN-DN</b> |

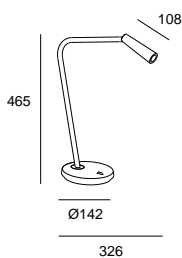

# Organic



## Performance Universe



P. 253



P. 308



### Inspiración orgánica

El perfil de esta pieza, suave y armónica, se inspira en las formas orgánicas de las flores y las hojas. Su pantalla ligeramente curvada, con un interior dorado, se integra en el espacio de sutil y natural.

### Inspiração orgânica

O perfil desta peça, suave e harmónica, é inspirado nas formas orgânicas das flores e folhas. O seu quebra-luz ligeiramente curvo, com um interior dourado, integra-se no espaço de forma subtil e natural.

## Organic

QS

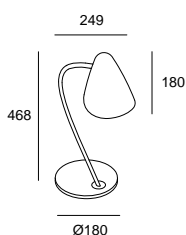
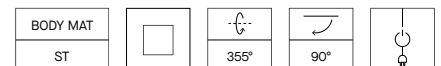

E27 Max. L 120 mm - Ø 80 mm | W Max. 15

Negro Preto 05 ●

### Structure

05 ●

\*Bombilla no incluída.  
\*Lâmpada não incluída.

### Code

10-7582-05-05

# Simply



## Essential Universe



P. 197



P. 353



### Diseño minimalista contemporáneo

Con un diseño contemporáneo y minimalista, Simply es una solución de luz para escritorio con cualidades técnicas y decorativas que la convierten en una opción siempre acertada.

### Design minimalista contemporâneo

Com um design contemporâneo e minimalista, Simply é uma solução de iluminação de secretária com qualidades técnicas e decorativas que a tornam uma excelente escolha.

## Simply

QS

BODY MAT  
ST.AL



355°

90°



Blanco Branco 14 ○  
Negro Preto 05 ●

GU10 | W Max. 8

### Structure

05 ●  
14 ○

\*Bombilla no incluída.  
\*Lâmpada não incluída.

### Code

10-7982-05-05  
10-7982-14-14

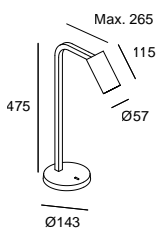

Incluido  
Incluído

Panel de abeja  
Favo de abelha

# Nude



## Essential Universe



P. 265



P. 312



### Diseño contemporáneo

El diseño contemporáneo de Nude se basa en la simplicidad de las formas y en destacar la belleza de la bombilla, que toma el protagonismo en esta amplia colección. La versión sobremesa incluye distintas posibilidades de instalación, lo que enriquece aún más la familia.

### Design contemporâneo

O design contemporâneo de Nude baseia-se na simplicidade das formas e em destacar a beleza da lâmpada, que ocupa o lugar central nesta ampla coleção. A versão de mesa inclui diferentes possibilidades de instalação, o que enriquece ainda mais a família.







05



DN

## Nude Curved

QS

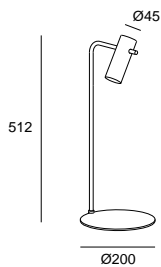

E27 120 mm or 95 mm Opal or Vintage finishing | W Max. 15

Negro Preto 05 ●  
Oro mate Ouro mate DN ●

Structure	Head	Code
05 ●	05 ●	10-8518-05-05
05 ●	DN ●	10-8518-05-DN

\*Bombilla no incluída.  
\*Lâmpada não incluída.

## Nude Tiny

QS

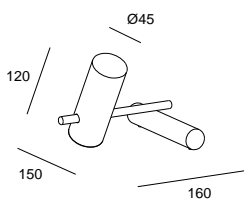
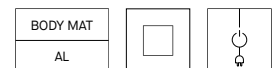

E27 120 mm or 95 mm Opal or Vintage finishing | W Max. 15

Negro Preto 05 ●  
Oro mate Ouro mate DN ●

Structure	Head	Code
05 ●	05 ●	10-8516-05-05
05 ●	DN ●	10-8516-05-DN

\*Bombilla no incluída.  
\*Lâmpada não incluída.

# Clip



## Essential Universe



P. 202



P. 268



Colección de aplique, sobremesa y pie de salón que, basándose en un diseño clásico, se desmarca con un plus de contemporaneidad marcado por la forma inclinada de su estructura.

Coleção de aplique, mesa e candeeiro de pé que, com base num design clássico, se destaca com um plus de contemporaneidade marcado pela forma inclinada da sua estrutura.



Opción de pantalla blanca y negra.  
Opção de quebra-luz branco e preto.

## Clip

QS

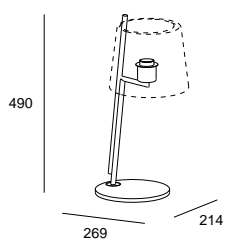

E27 | W Max. 15

Negro Preto 05 ●

### Structure

05 ●

\*Bombilla no incluída.  
\*Lâmpada não incluída.

### Code

10-8540-05-82

### Acc. comunes no incluidos y requeridos

Ac. comuns não incluído e requeridos

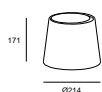

14 ○

05 ●

PAN-233-14

PAN-233-05

# Metrica



## Essential Universe



P. 204



P. 270



P. 313





Botón de encendido en la parte superior de la tija.

Botão de ligar/desligar na parte superior do espigão.



Opción de base redonda o cuadrada y acabos negro o níquel.

Opção de base redonda ou quadrada e acabamentos a preto ou níquel.

## Metrica Round

QS

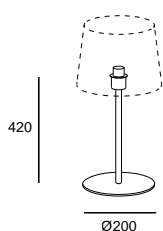

E27 | W Max. 15

Negro Preto 05 ●  
Níquel satinado Níquel acetinado 81 ●

Structure

Code

05 ●  
81 ●

10-4759-05-82

10-4759-81-82

\*Bombilla no incluida.  
\*Lâmpada não incluida.

## Metrica Square

QS

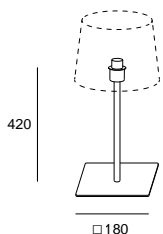
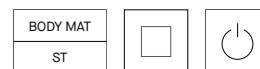

E27 | W Max. 15

Negro Preto 05 ●  
Níquel satinado Níquel acetinado 81 ●

Structure

Code

05 ●  
81 ●

10-8350-05-82

10-8350-81-82

\*Bombilla no incluida.  
\*Lâmpada não incluida.

QS Quick Service | 2-6 días laborables (tiempo de transporte no incluido)  
Quick Service | 2-6 dias úteis (tempo de transporte não incluido)

## No incluidos y requeridos

### Não incluido e requeridos

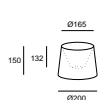

14 ○ PAN-157-14  
05 ● PAN-157-05  
BY ● PAN-157-BY

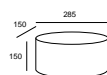

14 ○ PAN-177-14  
BY ● PAN-177-BY

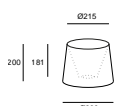

14 ○ PAN-161-14  
BY ● PAN-161-BY

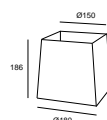

14 ○ PAN-179-14  
BY ● PAN-179-BY

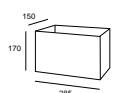

14 ○ PAN-176-14  
BY ● PAN-176-BY

# Portátil

## Portátil



Portobello

244



Cocktail

240

# Cocktail



Performance Universe



## Icónica y sugerente

Cocktail es una pieza icónica galardonada con el iF Design Awards. Francesc Vilaró se basa en el equilibrio, la industrialización, la innovación y la estética para crear una lámpara portátil que genera atmósferas adaptables a cada necesidad, gracias a su cabezal orientable y a la regulación de dimming con cuatro niveles de intensidad lumínica.

## Icônico e sugestivo

Cocktail é uma peça icónica galardoada com o iF Design Awards. Francesc Vilaró baseia-se no equilíbrio, industrialização, inovação e estética para criar um candeeiro portátil que gera atmosferas adaptáveis a cada necessidade graças à sua cabeça ajustável e à regulação de dimming com quatro níveis de intensidade lumínica.









O5



EX

**Cocktail**

QS

BODY MAT	DIF MAT					
AL	PC		350°	60°		USB C

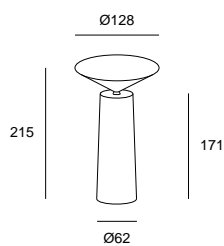
**LED | K 2700 | CRI 92 | W Total 3.5 | Real Lm 154**

Negro Preto O5 ●  
Gris oliva Cinzento oliva EX ●

**Structure****Code**

TOUCH DIMMING 100-240V

O5 ●  
EX ●

**10-8327-05-05**  
**10-8327-EX-EX**

**Incluido**  
**Incluído**

Cargador  
Carregador

**No incluido**  
**Não incluído**

Cargador múltiple  
Carregador múltiplo

**71-8332-05-00**

# Portobello



Essential Universe



## La sofisticación del color

Inspirada en la corriente pop art de los años 60 y 70, Portobello aporta un toque de color y sofisticación a ambientes muy diversos, que lo único que tienen en común es la ausencia de normas. Ligera y resistente, sus formas redondeadas la convierten en una pieza icónica, cercana y acogedora. En acabados estándar blanco y negro, la personalización de la pieza permite un número infinito de acabados para una integración total en cualquier espacio.

## A sofisticação da cor

Inspirada no movimento Pop Art dos anos 60 e 70, Portobello fornece um toque de cor e sofisticação a uma grande variedade de ambientes, em que a única coisa que têm em comum é a ausência de regras. Leve e resistente, as suas formas arredondadas tornam-na uma peça icónica, próxima e acolhedora. Em acabamentos standard branco e preto, a personalização da peça permite um número infinito de acabamentos para uma integração total em qualquer espaço.





Acabado personalizable mediante petición.  
Acabamento personalizável através de pedido.

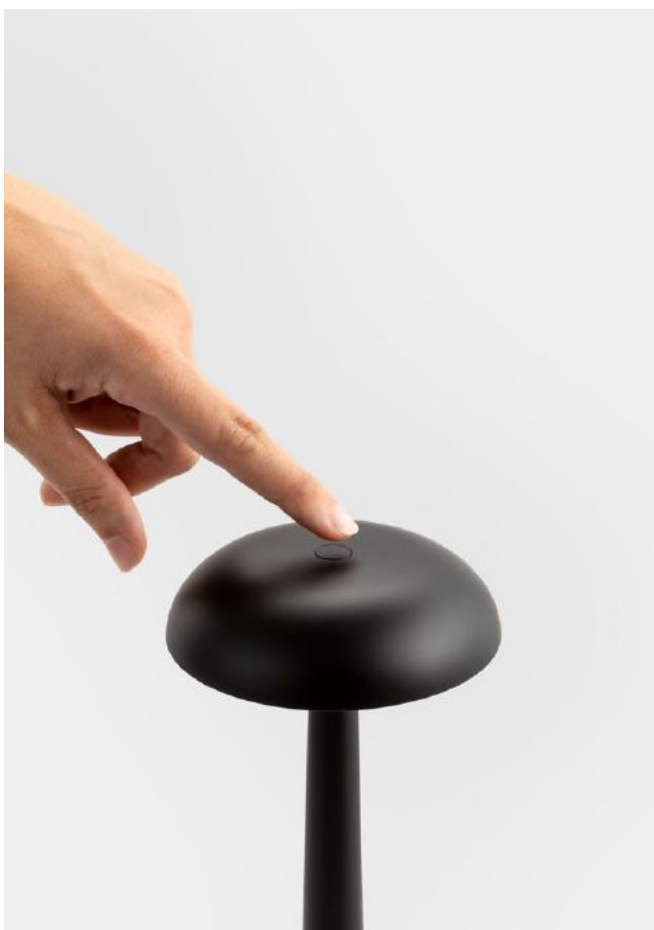

Boton touch dimmer con 3 intensidades.  
Botão touch dimmer com três intensidades.



Carga mediante USB-C.  
Carregamento via USB-C.

## Portobello

QS

BODY MAT	DIF MAT		IP		
ABS	PMMA		44		

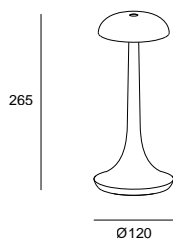

LED | K 2700 | CRI 92 | W Total 2.1 | Real Lm 137

Blanco Branco 14

Negro Preto 05



Structure

Code

TOUCH DIMMING 5VDC 1000mA

05

10-A001-05-05

14

10-A001-14-14

Incluido  
Incluído

Cable del cargador  
Cabo do carregador

No incluido  
Não incluído

Cargador múltiple  
Carregador múltiplo

71-8332-05-00

# Pie Pé



Levels

250

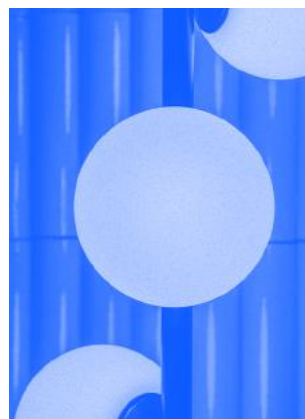

Perlina

254



Noway

256



H

258



Tubs

260



Invisible

262

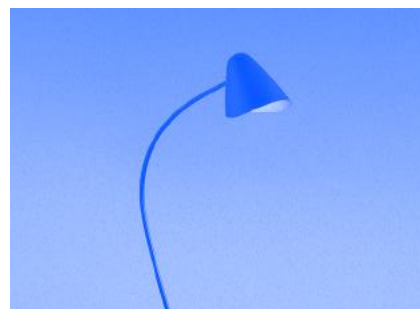

Organic

253



Nude

265

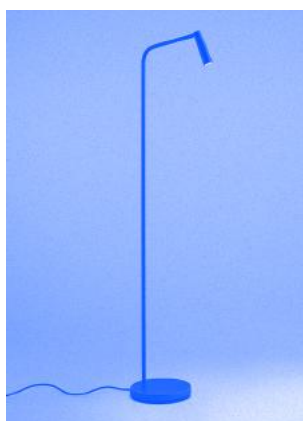

Gamma

264

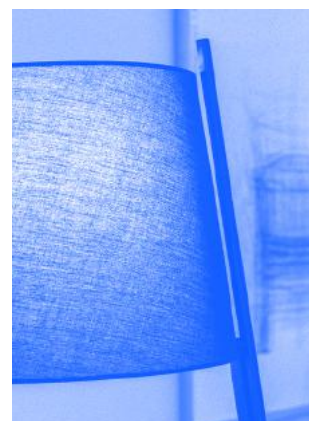

Clip

268



Metrica

270

# Levels



## Performance Universe



P. 086



P. 212



P. 328



### Porte elegante

De porte elegante y presencia destacada, el pie de la colección Levels puede componerse con opción individual o doble, en un juego de sensaciones gracias a las tonalidades del vidrio y las diferentes temperaturas de color, a elegir mediante el switch integrado en el cabezal del LED.

### Porte elegante

Com um aspeto elegante e uma presença excecional, o candeeiro de pé da coleção Levels pode ser composto com opção individual ou dupla, num jogo de sensações graças às tonalidades do vidro e às diferentes temperaturas de cor, a escolher através de switch integrado na cabeça do LED.



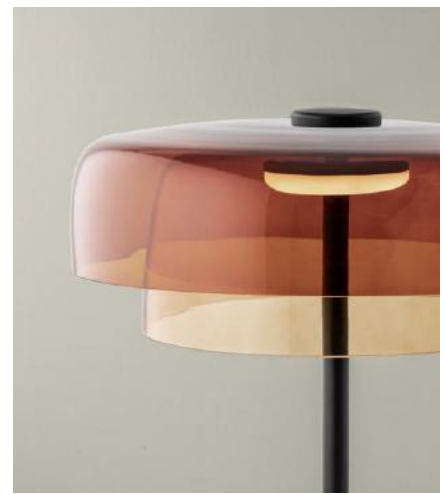

Vidrios con transparencias del 30% en el difusor pequeño, del 50% en el mediano y del 70% en el grande.  
 Vidros com transparências de 30% no difusor pequeno, de 50% no médio e de 70% no grande.

### Levels 1 Body Ø420mm

QS

BODY MAT	DIF MAT	SWITCH CCT	
ST	GLA	2700-3000-4000	

- Negro Preto 05 ●
- Verde Verde 08 ●
- Fumé Fumado 12 ●
- Âmbar Âmbar 15 ●

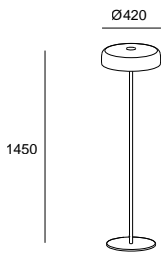

LED | K 2700-3000-4000 | CRI 92 | W Total 17 | Real Lm 750 (3000K)

	Structure	Difusor	Code
PUSH 220-240V	05 ●	08 ●	<b>25-A001-05-08</b>
	05 ●	12 ●	<b>25-A001-05-12</b>
	05 ●	15 ●	<b>25-A001-05-15</b>

### Levels 2 Bodies Ø420mm + Ø320mm

QS

BODY MAT	DIF MAT	SWITCH CCT	
ST	GLA	2700-3000-4000	

- Negro Preto 05 ●
- Verde Verde 08 ●
- Fumé Fumado 12 ●
- Âmbar Âmbar 15 ●

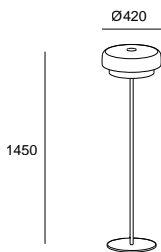

LED | K 2700-3000-4000 | CRI 92 | W Total 17 | Real Lm 750 (3000K)

	Structure	Difusor	Code
PUSH 220-240V	05 ●	08 ●	<b>25-A002-05-08</b>
	05 ●	12 ●	<b>25-A002-05-12</b>
	05 ●	15 ●	<b>25-A002-05-15</b>

\*Los acabados y tonalidad mostrados pueden no ser completamente precisos debido a ligeras variaciones en la producción, factores de iluminación, fotográficas e impresión.

\*Os acabamentos e tonalidades apresentados podem não ser totalmente precisos, devido a ligeiras variações na produção, fatores de iluminação fotográfica e de impressão.

# Organic



## Performance Universe



P. 229



P. 308



El perfil de esta pieza, suave y armónica, se inspira en las formas orgánicas de las flores y las hojas. Su pantalla ligeramente curvada, con un interior dorado, se integra en el espacio de forma sutil y natural.

O perfil desta peça, suave e harmónica, é inspirado nas formas orgânicas das flores e folhas. O seu quebra-luz ligeiramente curvo, com um interior dourado, integra-se no espaço de forma subtil e natural.

Luz dirigitible gracias a la rotación de sus ejes.  
Luz direcionável graças à rotação dos seus eixos.

### Organic

QS

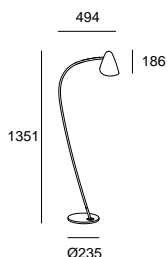
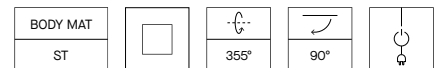

E27 | W Max. 15

Negro Preto 05 ●

#### Structure

05 ●

\*Bombilla no incluida.  
\*Lâmpada não incluída.

#### Code

25-7582-05-05

# Perlina



## Performance Universe



P. 182



P. 220



P. 276



P. 358



### Joya natural

Las tres esferas iluminadas de Perlina, distribuidas sobre su estructura lineal, permite ofrecer una luz cálida y agradable para aquellas zonas dónde se necesita mayor intensidad de luz de manera elegante. Aquí la fuerza de lo simple cobra todo el sentido en un juego entre la geometría del círculo y la pureza de la verticalidad.

### Joia natural

As três esferas iluminadas de Perlina, distribuídas na sua estrutura linear, oferecem uma luz quente e agradável para as áreas onde é necessária uma maior intensidade de luz de uma forma elegante. Aqui, a força da simplicidade assume todo o seu significado num jogo entre a geometria do círculo e a pureza da verticalidade.

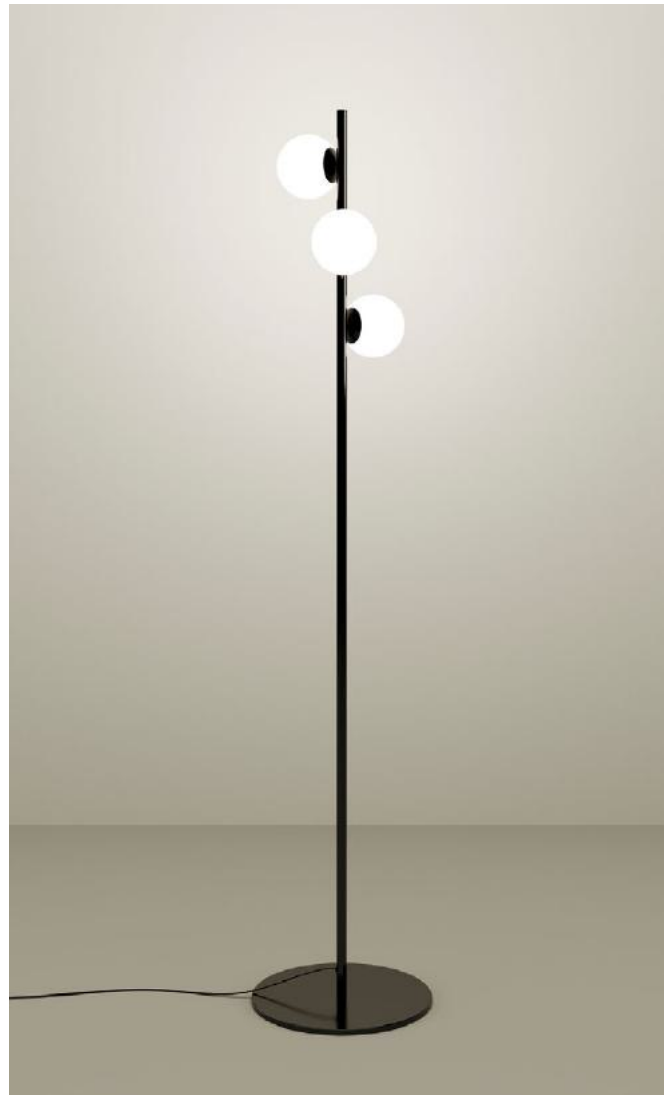

**Perlina**

**QS**

BODY MAT	DIF MAT	□	SWITCH CCT	⚡
ST	GLA		2700-3000-4000	

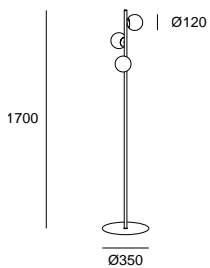

**LED | K 2700-3000-4000 | CRI 92 | W Total 22.9 | Real Lm 1172 (3000K)**

Negro Preto 60 ●  
Oro mate Ouro mate DN ●



**Structure Code**

ON-OFF 220-240V

60 ● **25-A076-60-60**  
DN ● **25-A076-DN-DN**

# Noway



## Performance Universe

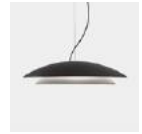

P. 124



### Suspensión

De presencia rotunda y protagonista, Noway incorpora un nuevo pie de salón ajustable con pértiga que se adueña del espacio con una sofisticación innata. Con diseño de doble pantalla, su efecto de luz es acogedor y confortable a partes iguales. Noway destaca de forma natural por sus cualidades estéticas y técnicas, convirtiéndose sin disimulo en el centro de atención de todas las miradas.

### Suspensão

Com uma presença enfática e protagonista, Noway incorpora um novo candeeiro de pé ajustável com um grande braço que toma conta do espaço com uma sofisticação inata. Com design de duplo quebra-luz, o seu efeito de luz é acolhedor e confortável em partes iguais. Noway destaca-se de forma natural pelas suas qualidades estéticas e técnicas, convertendo-se sem dissimular no centro das atenções de todos os olhares.



La pantalla del nivel inferior siempre con acabado negro.  
O quebra-luz do nivel inferior sempre com acabamento preto.

## Noway Big

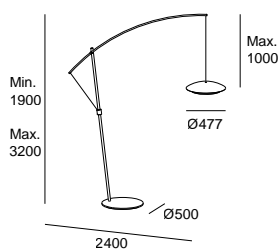
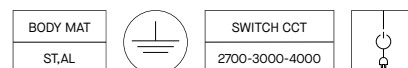

LED | K 2700-3000-4000 | CRI 92 | W Total 25.4 | Real Lm 813 (3000K)

Negro Preto 05 ●

	Upper Screen	Lower Screen	Structure	Code
PUSH 220-240V	05 ●	05 ●	05 ●	<b>25-8566-05-05</b>
ON-OFF 220-240V	05 ●	05 ●	05 ●	<b>25-8394-05-05 QS</b>

Acc. comunes incluidos  
Ac. comuns incluídos

Clip regulación altura  
Clipe regulação altura

H



## Performance Universe



P. 140



P. 216



P. 306

**Belleza atemporal**

La colección de luminarias H nace como una reinterpretación contemporánea del clásico sobremesa de pantalla cónica. La versatilidad de la colección permite iluminar diferentes espacios de forma delicada, mediante piezas que aportan un gran valor representativo.



**Elegância inata**

A coleção de luminárias H nasce como uma reinterpretação contemporânea do clássico de mesa de quebra-luz cônico. A versatilidade da coleção permite iluminar diferentes espaços de forma delicada, mediante peças que proporcionam um grande valor representativo.





H

QS

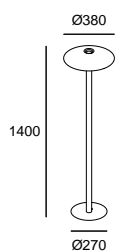
BODY MAT	DIF MAT	 
ST	ACR	



LED | K 2700 | CRI 92 | W Total 277 | Real Lm 1328

Negro Preto 05   
Oro mate Ouro mate DN 



Structure

Code

ON-OFF 220-240V

05   
DN 

**25-7742-05-05**  
**25-7742-DN-DN**

**QS** Quick Service | 2-6 días laborables (tiempo de transporte no incluido)  
Quick Service | 2-6 dias úteis (tempo de transporte não incluído)

# Tubs



Performance Universe



P. 222



P. 289



## Presencia y dinamismo

Tubs es un pie de salón con una fuente de luz en forma lineal que tiene una amplia capacidad de movimientos, lo que ofrece un gran dinamismo a la pieza y dota de carácter el espacio que habita. Sofisticada y elegante, con base de mármol, puede regularse mediante touch dimming, adaptándose a las necesidades lumínicas de cada momento con una destacada presencia.

## Presencia y dinamismo

Tubs é um candeeiro de pé com uma fonte de luz em forma linear que apresenta uma ampla capacidade de movimentos, o que confere grande dinamismo à peça dotando de carácter o espaço que habita. Sofisticada e elegante, com uma base em mármore preto, pode ser regulada mediante touch dimming, adaptando-se às necessidades lumínicas de cada momento com uma presença marcante.



**Tubs**

**QS**

BODY MAT	DIF MAT					
ST,AL,MAR	PC		360°	0-90°	360°	DIM

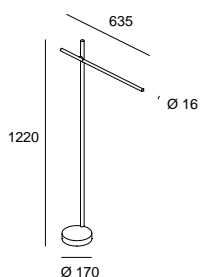

**LED | CRI 92 | W Total 9.5**

Negro Preto 05 ●  
Blanco opal Branco opalino M1 ○

	K	Real Lm	Structure	Difusor	Code
TOUCH DIMMING 220-240V	2700 3000	479 504	05 ● 05 ●	M1 ○ M1 ○	<b>25-A026-05-M1</b> <b>25-8102-05-M1</b>

**QS** Quick Service | 2-6 días laborables (tiempo de transporte no incluido)  
Quick Service | 2-6 dias úteis (tempo de transporte não incluído)

# Invisible



## Performance Universe



P. 151



P. 184



P. 226

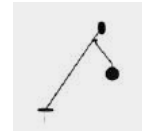

P. 292



### Movimiento en equilibrio

Francesc Vilaró se inspiró en los móviles del escultor Alexander Calder para diseñar la colección Invisible, buscando el equilibrio entre las líneas que forman la estructura y el círculo que las une haciendo de contrapeso. En esta composición de balances, la luz puede dirigirse a cualquier punto, proyectando una luz de acento de forma muy honesta, con una gran libertad de movimientos en todas sus versiones. Invisible es una pieza icónica que ha recibido el premio German Design Award.

### Movimento em equilíbrio

Francesc Vilaró inspirou-se nos móveis do escultor Alexander Calder para criar a coleção Invisible, procurando um equilíbrio entre as linhas que formam a estrutura e o círculo que as une como contrapeso. Nesta composição de equilíbrios, a luz pode ser dirigida para qualquer ponto, projetando uma luz de realce de uma forma muito honesta, com uma grande liberdade de movimentos em todas as suas versões. Invisible é uma peça icónica que recebeu o German Design Award.





La rotación del cabezal permite dirigir la luz.

A rotação da cabeça permite dirigir a luz.

## Invisible

QS

BODY MAT	DIF MAT					
ST,AL	PMMA		355°	355°	±90°	

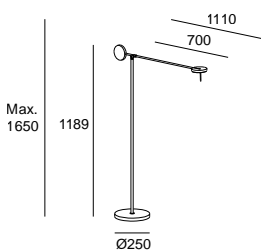

LED | CRI 92 | W Total 10.5

Negro Preto 05 ●

	K	Real Lm	Structure	Code
TOUCH DIMMING 100-240V	2700 3000	534 550	05 ● 05 ●	<b>25-7385-05-05</b> <b>25-5693-05-05</b>

# Gamma



## Performance Universe

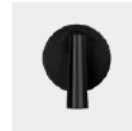

P. 192



P. 194



P. 228

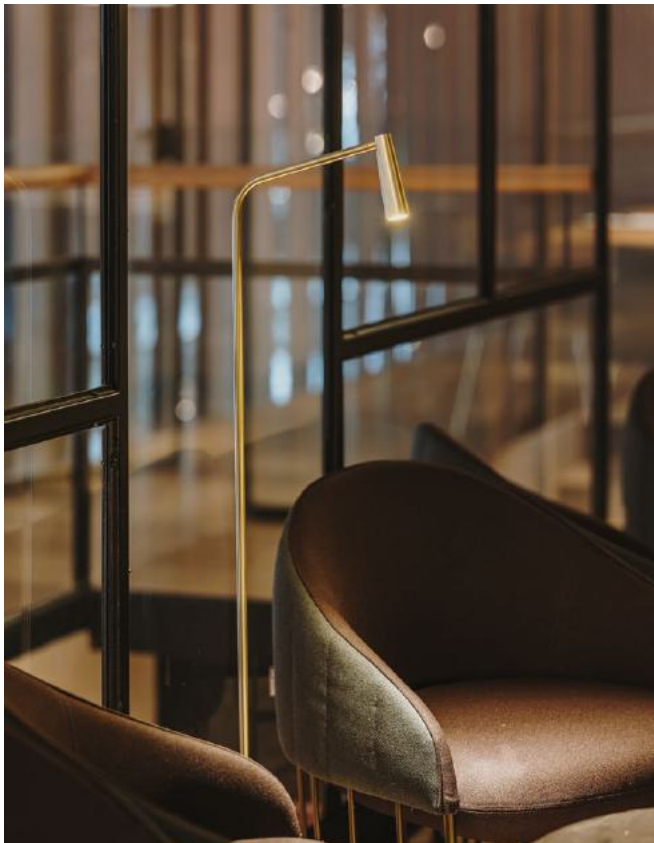

La opción pie de salón se presenta como una versión muy minimalista que convive con naturalidad en los ambientes que habita.

A opção de pé apresenta-se como uma versão muito minimalista que convive com naturalidade nos ambientes que habita.

Rotación tanto del cabezal como de su eje.  
Rotação tanto da cabeça como do seu eixo.

### Gamma

QS

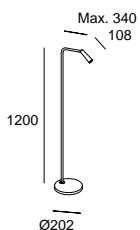
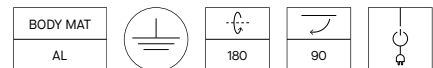

LED | K 2700 | CRI 92 | W Total 4.3 | Real Lm 293

Negro Preto 05 ●  
Oro mate Ouro mate DN ●



ON-OFF 100-240V

Structure

Code

05 ●  
DN ●

**25-6420-05-05**  
**25-6420-DN-DN**

# Nude



Essential Universe



P. 231



P. 312



## Diseño contemporáneo

El diseño contemporáneo de Nude se basa en la simplicidad de las formas y en destacar la belleza de la bombilla, que toma el protagonismo en esta amplia colección. La versión pie de salón incluye la opción de tres estructuras distintas.

## Design contemporâneo

O design contemporâneo de Nude baseia-se na simplicidade das formas e em destacar a beleza da lâmpada, que ocupa o lugar central nesta ampla coleção. A versão de candeeiro de chão inclui a opção de três estruturas diferentes.



Incluye gomas para ajustar el cableado.  
Inclui borrachas para ajustar a cablagem.



05



DN

## Nude Single

QS

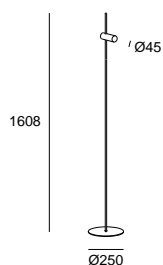
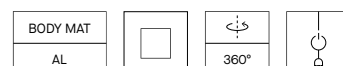

E27 | W Max. 15

Negro Preto 05 ●  
Oro mate Ouro mate DN ●

Structure	Head	Code
05 ●	05 ●	25-8520-05-05
05 ●	DN ●	25-8520-05-DN

\*Bombilla no incluída.  
\*Lâmpada não incluída.

## Nude Curved

QS

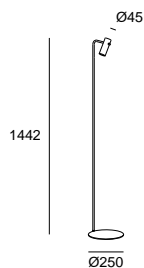
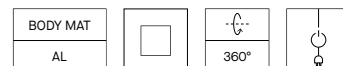

E27 | W Max. 15

Negro Preto 05 ●  
Oro mate Ouro mate DN ●

Structure	Head	Code
05 ●	05 ●	25-8522-05-05
05 ●	DN ●	25-8522-05-DN

\*Bombilla no incluída.  
\*Lâmpada não incluída.

## Nude Double

QS

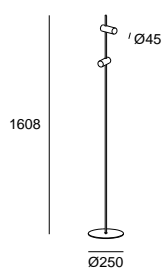
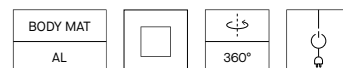

E27 | W 2 × Max. 15

Negro Preto 05 ●  
Oro mate Ouro mate DN ●

Structure	Head	Code
05 ●	05 ●	25-8521-05-05
05 ●	DN ●	25-8521-05-DN

\*Bombilla no incluída.  
\*Lâmpada não incluída.

# Clip



## Essential Universe

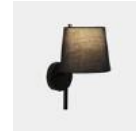

P. 202



P. 234



Colección de aplique, sobremesa y pie de salón que, basándose en un diseño clásico, se destaca con un plus de contemporaneidad marcado por la forma inclinada de su estructura.

Coleção de aplique, mesa e candeeiro de pé que, com base num design clássico, se destaca com um plus de contemporaneidade marcado pela forma inclinada da sua estrutura.





## Clip

QS

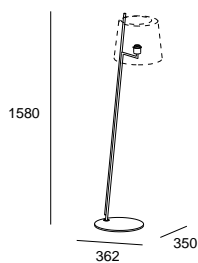
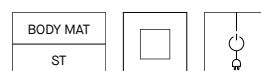

E27 | W Max. 15

Negro Preto 05 ●

## Structure

## Code

05 ●

25-8540-05-82

\*Bombilla no incluida.  
\*Lâmpada não incluída.

No incluidos y requeridos  
Não incluído e requeridos

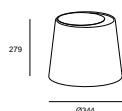

14 ○

05 ●

PAN-234-14

PAN-234-05

# Metrica



## Essential Universe

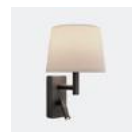

P. 204



P. 236



P. 313





Opción de base redonda o cuadrada y acabos negro o níquel.  
Opção de base redonda ou quadrada e acabamentos a preto ou níquel.

### Metrica Round

QS

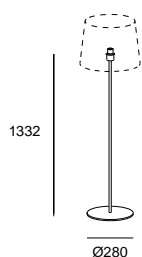

E27 | W Max. 15

#### Structure

05 ●  
81 ●

\*Bombilla no incluída.  
\*Lâmpada não incluída.

#### Code

25-4759-05-82

25-4759-81-82

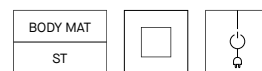

Negro Preto 05 ●  
Níquel satinado Níquel acetinado 81 ●

### Metrica Square

QS

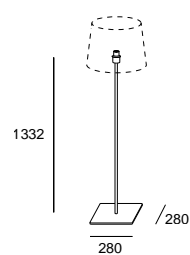

E27 | W Max. 15

#### Structure

05 ●  
81 ●

\*Bombilla no incluída.  
\*Lâmpada não incluída.

#### Code

25-8350-05-82

25-8350-81-82



Negro Preto 05 ●  
Níquel satinado Níquel acetinado 81 ●

### No incluidos y requeridos

Não incluído e requeridos

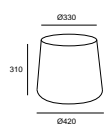

14 ○ PAN-159-14  
BY ● PAN-159-BY

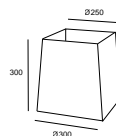

BY ● PAN-181-BY

# Superficie de pared

## Superfície de parede

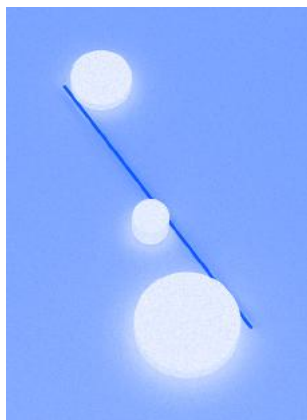

Spark

278



Perlina

276



Trip Glass

286



Trip

281



Bloom

288

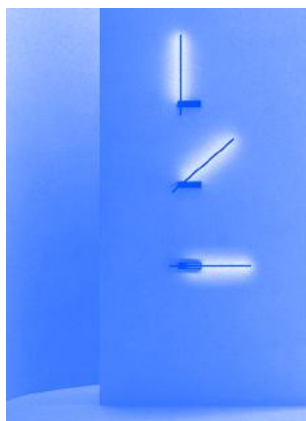

Tubs

289



Invisible

292



Veneto

298

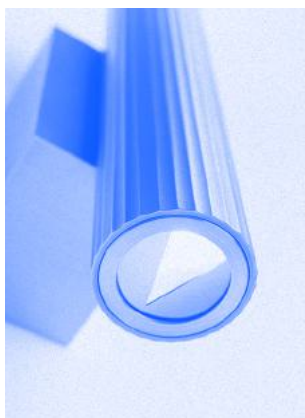

Prolix

294

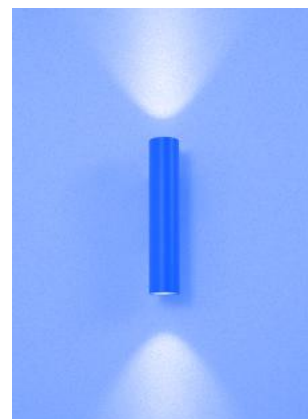

Linea

296

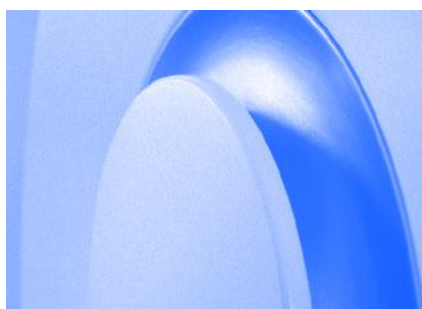

Big Bang

299



Attic

300

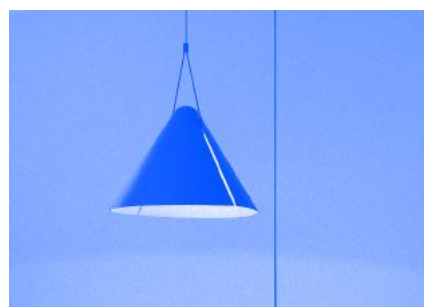

Super Attic

304



Organic

308

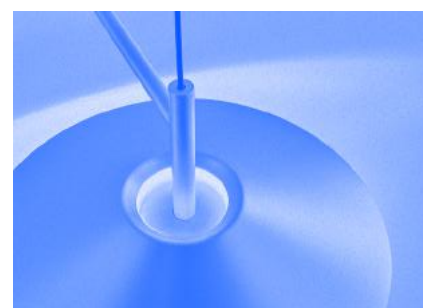

H

306

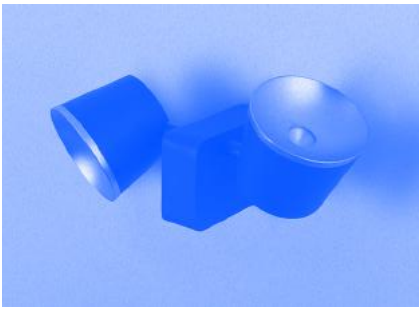

**Drone**

**310**



**Miso**

**309**

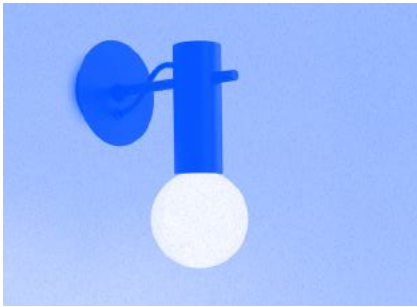

**Nude**

**312**



**Vetro**

**311**

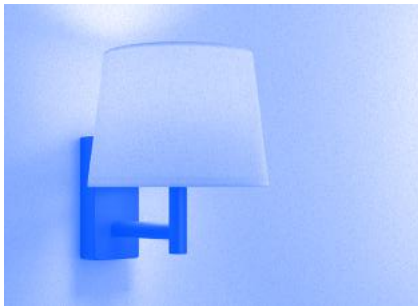

**Metrica**

**313**

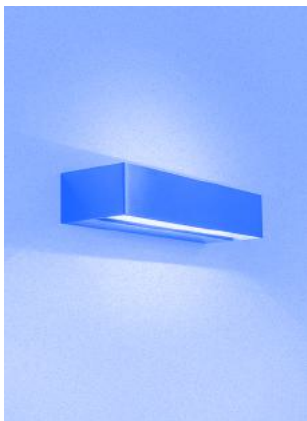

**Lia**

**317**

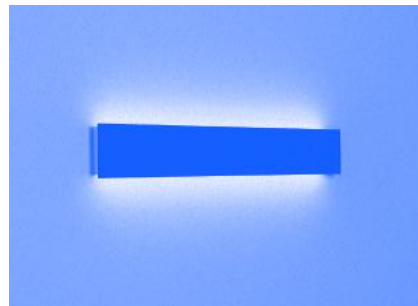

**Fino**

**314**

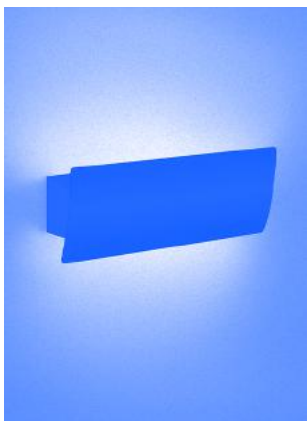

Duna 316



Lia LED 318

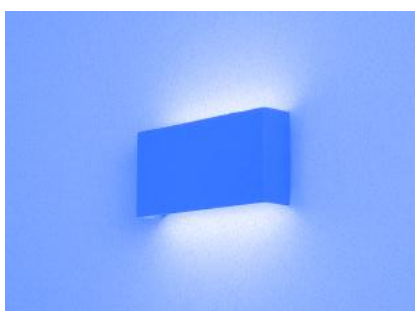

Mini 320

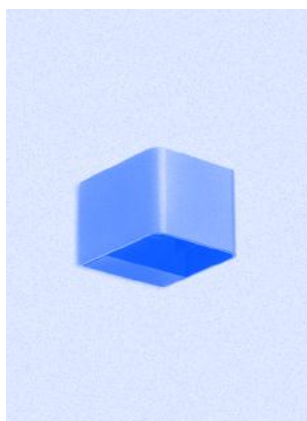

Wilson 323

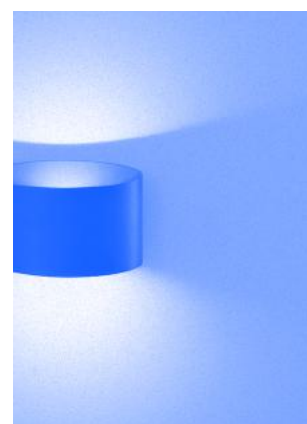

Cut 322



Ges Circular 325

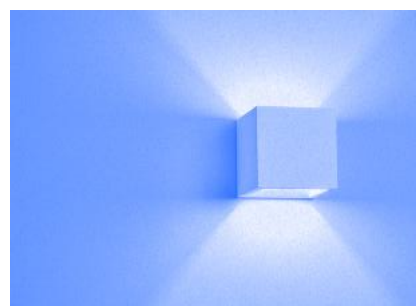

Ges 324

# Perlina



## Performance Universe



P. 182



P. 220



P. 254



P. 358



### Joya natural

Perlina se inspira en una joya natural para ofrecer una perla iluminada que juega con la esencia de la circunferencia, redonda y perfecta, dando sentido al minimalismo de lo básico. Cuando está encendida, su efecto de luz tamizada transmite un sentimiento de calma llenando el espacio con naturalidad y acomodándose a él gracias a la posibilidad de regulación manual mediante dimmer.

### Joia natural

Perlina inspira-se numa joia natural para oferecer uma pérola iluminada que brinca com a essência da circunferência, redonda e perfeita, dando sentido ao minimalismo do básico. Quando acesa, o seu efeito de luz filtrada transmite uma sensação de calma, preenchendo naturalmente o espaço e adaptando-se a ele graças à possibilidade de regulação manual através de dimmer.



## Perlina IP44

QS

BODY MAT	DIF MAT		IP	SWITCH CCT
AISI304	GLA		44	2700-3000-4000

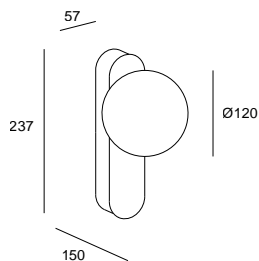

LED | K 2700-3000-4000 | CRI 92 | W Total 8.8 | Real Lm 391 (3000K)

Negro Preto 60 ●  
Oro mate Ouro mate DN ●



ON-OFF 220-240V

DALI-2 220-240V

Structure Code

60 ●	<b>05-A076-60-60</b>
DN ●	<b>05-A076-DN-DN</b>
60 ●	<b>05-A077-60-60</b>
DN ●	<b>05-A077-DN-DN</b>

# Spark



Performance Universe



P. 340



## Inspiración nórdica

De inspiración nórdica, la sencillez de los elementos encuentra su razón de ser en la perfección de las formas y en sus combinaciones. Con distintas posibilidades de composición Spark propone un juego de volúmenes que se combinan alrededor de un perfil que pasa prácticamente desapercibido. Diseñada sin ataduras, sus posibilidades de instalación responden a su misma esencia de libertad.

## Inspiração nórdica

De inspiração nórdica, a simplicidade dos elementos encontra a sua razão de ser na perfeição das formas e nas suas combinações. Com diferentes possibilidades de composição Spark propõe um jogo de volumes que se combinam em torno de um perfil que passa praticamente despercebido. Concebida sem laços, as suas possibilidades de instalação respondem à sua própria essência de liberdade.

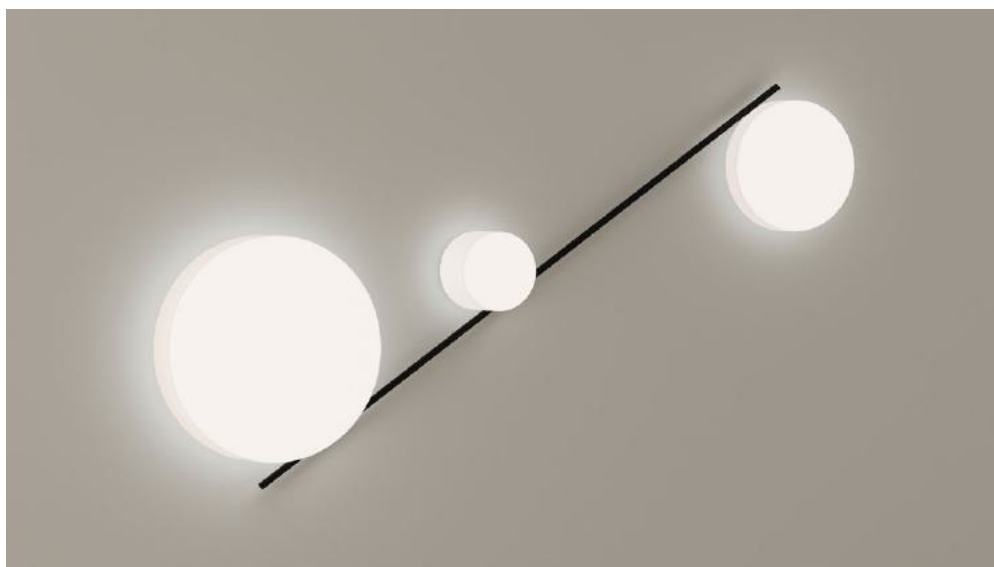

Los tres cuerpos lumínicos generan tres volúmenes diferenciados.

Os três corpos lumínicos geram três volumes diferenciados.

### Spark Single Ø140mm

BODY MAT	DIF MAT		SWITCH CCT
ST	GLA		2700-3000-4000

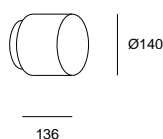

LED | K 2700-3000-4000 | CRI 92 | W Total 10 | Real Lm 424 (3000K)

Negro Preto 05 ●  
Arenado Areado F9 ○

	Structure	Difussor	Code
	PHASE CUT 220-240V	05 ●	F9 ○
			<b>15-A125-05-F9</b>

### Spark Single Ø240mm

BODY MAT	DIF MAT		SWITCH CCT
ST	GLA		2700-3000-4000

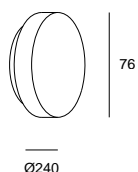

LED | K 2700-3000-4000 | CRI 92 | W Total 16 | Real Lm 652 (3000K)

Negro Preto 05 ●  
Arenado Areado F9 ○

	Structure	Difussor	Code
	PHASE CUT 220-240V	05 ●	F9 ○
			<b>15-A126-05-F9</b>

### Spark Single Ø390mm

BODY MAT	DIF MAT		SWITCH CCT
ST	GLA		2700-3000-4000

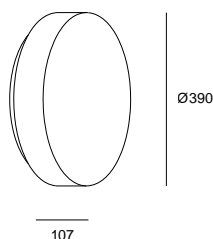

LED | K 2700-3000-4000 | CRI 92 | W Total 43.7 | Real Lm 2083 (3000K)

Negro Preto 05 ●  
Arenado Areado F9 ○

	Structure	Difussor	Code
	DALI 220-240V	05 ●	F9 ○
			<b>15-A127-05-F9</b>

### Spark Double Ø390mm + Ø140mm

BODY MAT
ST

DIF MAT
GLA



SWITCH CCT
2700-3000-4000

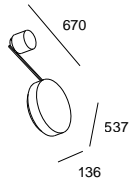

LED | K 2700-3000-4000 | CRI 92 | W Total 53.5 | Real Lm 2507 (3000K)

Negro Preto 05 ●  
Arenado Areado F9 ○

	Structure	Difussor	Code
DALI 220-240V	05 ●	F9 ○	15-A128-05-F9

### Spark Double Ø390mm + Ø240mm

BODY MAT
ST

DIF MAT
GLA



SWITCH CCT
2700-3000-4000

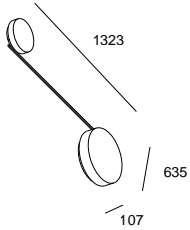

LED | K 2700-3000-4000 | CRI 92 | W Total 60.5 | Real Lm 2735 (3000K)

Negro Preto 05 ●  
Arenado Areado F9 ○

	Structure	Difussor	Code
DALI 220-240V	05 ●	F9 ○	15-A129-05-F9

### Spark Triplex Ø390mm + Ø240mm + Ø140mm

BODY MAT
ST

DIF MAT
GLA



SWITCH CCT
2700-3000-4000

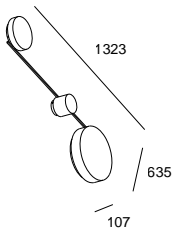

LED | K 2700-3000-4000 | CRI 92 | W Total 68.5 | Real Lm 3159 (3000K)

Negro Preto 05 ●  
Arenado Areado F9 ○

	Structure	Difussor	Code
DALI 220-240V	05 ●	F9 ○	15-A130-05-F9



Desarrollado de forma minuciosa para conseguir un vidrio de calidad y un perfil muy fino con las mejores prestaciones técnicas.

Desenvolvido de forma minuciosa para conseguir um vidro de qualidade e um perfil muito fino com as melhores prestações técnicas.

# Trip



Performance Universe



## Versátil e imaginativa

Trip es un aplique pensado para decorar paredes con su sola presencia, marcada por el entramado en rejilla de su cuerpo metálico, sus posibilidades de combinación, ya sea simple, doble o triple con distintos acabados y el efecto que proporciona su punto de luz suave, difuso y asimétrico.

## Versátil e imaginativo

Trip é um candeeiro de parede concebido para decorar paredes com a sua mera presença, marcada pela moldura quadriculada do seu corpo metálico, pelas suas possibilidades de combinação, sejam elas simples, duplas ou triplas com diferentes acabamentos e pelo efeito proporcionado pela sua fonte de luz suave, difusa e assimétrica.

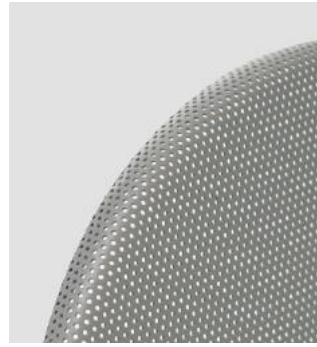
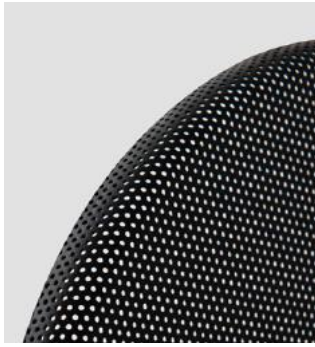





## Trip 300mm

QS

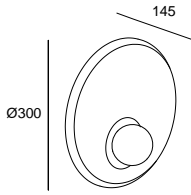
BODY MAT	DIF MAT	
ST,AL	GLA	







E14 Max. L 90 mm - Ø 50 mm | W Max. 9

Negro Preto 05   
Oro mate Ouro mate DN 

Structure	Small	Code
05 	05 	<b>05-8356-05-05</b>
05 	DN 	<b>05-8356-05-DN</b>

Acabados The Colours bajo pedido mínimo de 15 unidades. Consultar precios en tarifa y plazos de entrega con equipo comercial.  
Acabamentos The Colours sujeitos a encomenda mínima de 15 unidades. Consultar preços e prazos de entrega com a nossa equipa comercial.

Structure: 05  Negro Preto      Small: 14  Blanco Branco  
05  Negro Preto      EM  Gris piedra Cinzento pedra



## Trip 460mm

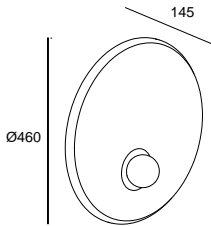

QS

BODY MAT	DIF MAT	
ST,AL	GLA	







E14 Max. L 90 mm - Ø 50 mm | W Max. 9

Negro Preto 05   
Oro mate Ouro mate DN 

Structure	Big	Code
05 	05 	<b>05-8357-05-05</b>
05 	DN 	<b>05-8357-05-DN</b>

Acabados The Colours bajo pedido mínimo de 15 unidades. Consultar precios en tarifa y plazos de entrega con equipo comercial.  
Acabamentos The Colours sujeitos a encomenda mínima de 15 unidades. Consultar preços e prazos de entrega com a nossa equipa comercial.

Structure: 05  Negro Preto      Big: 14  Blanco Branco  
05  Negro Preto      EM  Gris piedra Cinzento pedra



## Trip Double 535mm



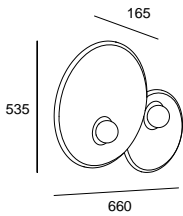





QS

BODY MAT	DIF MAT	
ST,AL	GLA	









E14 Max. L 90 mm - Ø 50 mm | W 2 × Max. 9

Negro Preto 05   
Oro mate Ouro mate DN 

Structure	Small	Big	Code
05 	05 	05 	<b>05-8359-05-05</b>
05 	DN 	DN 	<b>05-8359-05-DN</b>
05 	05 	DN 	<b>05-8359-05-DP</b>

Acabados The Colours bajo pedido mínimo de 15 unidades. Consultar precios en tarifa y plazos de entrega con equipo comercial.  
Acabamentos The Colours sujeitos a encomenda mínima de 15 unidades. Consultar preços e prazos de entrega com a nossa equipa comercial.

Structure: 05  Negro Preto      Small: 14  Blanco Branco      Big: 14  Blanco Branco  
05  Negro Preto      EM  Gris piedra Cinzento pedra      EM  Gris piedra Cinzento pedra



## Trip Double 650mm



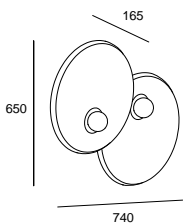





QS

BODY MAT	DIF MAT	
ST,AL	GLA	









E14 Max. L 90 mm - Ø 50 mm | W 2 × Max. 9

Negro Preto 05   
Oro mate Ouro mate DN 

Structure	Big	Big	Code
05 	05 	05 	<b>05-8360-05-05</b>
05 	DN 	DN 	<b>05-8360-05-DN</b>
05 	05 	DN 	<b>05-8360-05-DP</b>

Acabados The Colours bajo pedido mínimo de 15 unidades. Consultar precios en tarifa y plazos de entrega con equipo comercial.  
Acabamentos The Colours sujeitos a encomenda mínima de 15 unidades. Consultar preços e prazos de entrega com a nossa equipa comercial.

Structure: 05  Negro Preto      Big: 14  Blanco Branco      Big: 14  Blanco Branco  
05  Negro Preto      EM  Gris piedra Cinzento pedra      EM  Gris piedra Cinzento pedra

## Trip Double 420mm

QS

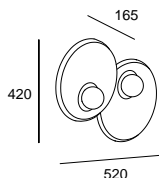

BODY MAT	DIF MAT	
ST,AL	GLA	

E14 Max. L 90 mm - Ø 50 mm | W 2 × Max. 9

 Negro Preto 05   
 Oro mate Ouro mate DN 

Structure	Small	Small	Code
05	05	05	<b>05-8361-05-05</b>
05	DN	DN	<b>05-8361-05-DN</b>
05	05	DN	<b>05-8361-05-DP</b>

Acabados The Colours bajo pedido mínimo de 15 unidades. Consultar precios en tarifa y plazos de entrega con equipo comercial.  
 Acabamentos The Colours sujeitos a encomenda mínima de 15 unidades. Consultar preços e prazos de entrega com a nossa equipa comercial.

**Structure:** 05 Negro Preto    **Small:** 14 Blanco Branco    **Small:** 14 Blanco Branco  
 05 Negro Preto    EM Gris piedra Cinzento pedra    EM Gris piedra Cinzento pedra

## Trip Triple 650mm

QS

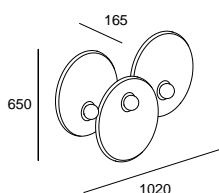

BODY MAT	DIF MAT	
ST,AL	GLA	

E14 Max. L 90 mm - Ø 50 mm | W 3 × Max. 9

 Negro Preto 05   
 Oro mate Ouro mate DN 

Structure	Big	Big	Big	Code
05	05	05	05	<b>05-8362-05-05</b>
05	DN	DN	DN	<b>05-8362-05-DN</b>
05	DN	05	DN	<b>05-8362-05-DP</b>

Acabados The Colours bajo pedido mínimo de 15 unidades. Consultar precios en tarifa y plazos de entrega con equipo comercial.  
 Acabamentos The Colours sujeitos a encomenda mínima de 15 unidades. Consultar preços e prazos de entrega com a nossa equipa comercial.

**Structure:** 05 Negro Preto    **Big:** 14 Blanco Branco    **Big:** 14 Blanco Branco    **Big:** 14 Blanco Branco  
 05 Negro Preto    EM Gris piedra Cinzento pedra    EM Gris piedra Cinzento pedra    EM Gris piedra Cinzento pedra

## Trip Triple 535mm

QS

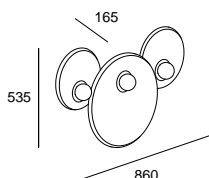

BODY MAT	DIF MAT	
ST,AL	GLA	

E14 Max. L 90 mm - Ø 50 mm | W 3 × Max. 9

 Negro Preto 05   
 Oro mate Ouro mate DN 

Structure	Small	Big	Small	Code
05	05	05	05	<b>05-8363-05-05</b>
05	DN	DN	DN	<b>05-8363-05-DN</b>
05	DN	05	DN	<b>05-8363-05-DP</b>

Acabados The Colours bajo pedido mínimo de 15 unidades. Consultar precios en tarifa y plazos de entrega con equipo comercial.  
 Acabamentos The Colours sujeitos a encomenda mínima de 15 unidades. Consultar preços e prazos de entrega com a nossa equipa comercial.

**Structure:** 05 Negro Preto    **Small:** 14 Blanco Branco    **Big:** 14 Blanco Branco    **Small:** 14 Blanco Branco  
 05 Negro Preto    EM Gris piedra Cinzento pedra    EM Gris piedra Cinzento pedra    EM Gris piedra Cinzento pedra

# Trip Glass



Performance Universe



## Diseño clásico y orgánico

El óvalo de vidrio soplado de forma artesanal rodea la fuente de luz creando un agradable efecto luminoso. Trip Glass es un aplique clásico con una personalidad atemporal, que se presenta en dos tonalidades, ambar y fumé.

## Design clássico e orgânico

El oval de vidro soprado de forma artesanal envolve a fonte de luz criando um efeito luminoso muito agradável. Trip Glass é um aplique clássico com uma personalidade intemporal, disponível em duas tonalidades, âmbar e fumado.



Tonalidad ámbar al 30%.  
Matiz ámbar a 30%.



Tonalidad fumé al 50%.  
Matiz fumê a 50%.

## Trip Glass

QS

BODY MAT	DIF MAT	
AL	GLA	

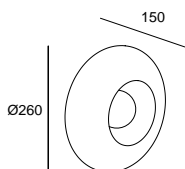

**E14 Max. L 90 mm - Ø 50 mm | W Max. 9**

Negro Preto 05 ●  
Fumé Fumado 12 ●  
Ámbar Âmbar 15 ●

Structure	Body	Code
05 ●	12 ●	<b>05-8358-05-12</b>
05 ●	15 ●	<b>05-8358-05-15</b>

\*Los acabados y tonalidad mostrados pueden no ser completamente precisos debido a ligeras variaciones en la producción, factores de iluminación, fotográficas e impresión.

\*Os acabamentos e tonalidades apresentados podem não ser totalmente precisos, devido a ligeiras variações na produção, fatores de iluminação fotográfica e de impressão.

# Bloom



Essential Universe



P. 360



## Diseño amable y sencillez de las formas

La sencillez y la funcionalidad son a menudo la mejor carta de presentación. Bloom tiene un diseño amable, equilibrado en las formas, que la hacen destacar en el espacio precisamente por la suavidad de su perfil. Su desarrollo técnico, con un IP44 certificado, la convierten en una luminaria muy versátil para diferentes ambientes.

## Design amigável e simplicidade de formas

A simplicidade e a funcionalidade são muitas vezes a melhor carta de apresentação. Bloom tem um design afável, equilibrado nas formas, o que a fazem sobressair devido à suavidade do seu perfil. O seu desenvolvimento técnico torna-a uma luminária muito versátil para diferentes ambientes, graças ao seu IP44.

Superfície de pared | Superfície de parede

Decorative Collection

288

### Bloom

QS

BODY MAT	DIF MAT		IP
ST	GLA		44

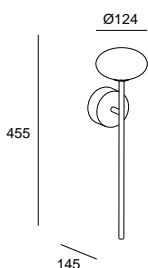

LED | K 2700 | CRI 92 | W Total 7.5 | Real Lm 262

Negro Preto 05 ●

ON-OFF 100-277V

Structure Code

05 ● 05-A011-05-M1

QS Quick Service | 2-6 días laborables (tiempo de transporte no incluido)  
Quick Service | 2-6 dias úteis (tempo de transporte não incluido)

# Tubs



## Performance Universe



P. 222



P. 260



### Presencia y dinamismo

Tubs es un diseño Deco Tech que presenta la luz a través de tramos rectos y orientables. Tubs aplique puede rotar tanto desde su difusor, dirigiendo el haz de luz donde sea preciso, como desde su eje, con orientación sobre sus diferentes ejes longitudinales.

### Presença e dinamismo

Tubs é um design Deco Tech que apresenta a luz através de secções retas e orientáveis. A luminária de parede Tubs pode girar tanto a partir de seu difusor, direcionando o feixe de luz para onde for necessário, quanto a partir de seu eixo, com orientação em seus diferentes eixos longitudinais.



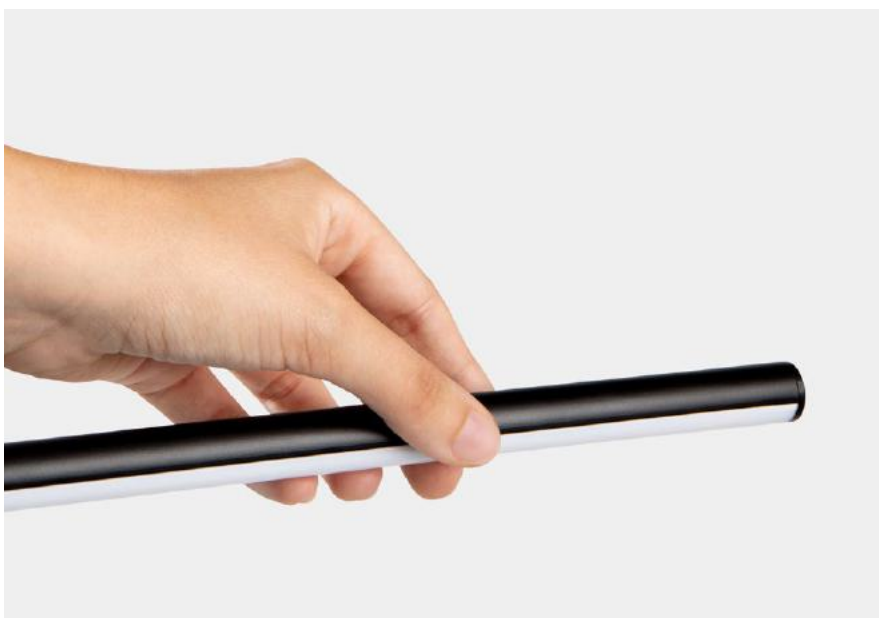

Amplia capacidad de movimientos: el difusor puede rotarse 360°, al mismo tiempo que la rótula del brazo.  
 Grande amplitude de movimentos: o difusor pode rodar 360°, ao mesmo tempo que a junta esférica do braço.

## Tubs

BODY MAT	DIF MAT				
ST,AL	PC		360°	0-90°	0-90°

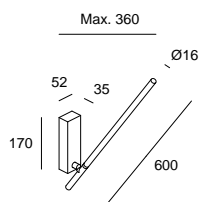

LED | CRI 92 | W Total 8.4

Negro Preto 05 ●  
 Blanco opal Branco opalino M1 ○

	K	Real Lm	Structure	Difusor	Code
ON-OFF 220-240V	2700	506	05 ●	M1 ○	<b>05-A026-05-M1</b> QS
0-10V 120-277V	2700	506	05 ●	M1 ○	<b>05-A028-05-M1</b>
DALI-2 220-240V	2700	506	05 ●	M1 ○	<b>05-A027-05-M1</b>
ON-OFF 220-240V	3000	471	05 ●	M1 ○	<b>05-8102-05-M1</b> QS
0-10V 120-240V	3000	471	05 ●	M1 ○	<b>05-8104-05-M1</b>
DALI-2 220-240V	3000	471	05 ●	M1 ○	<b>05-8103-05-M1</b>

# Invisible



## Performance Universe



P. 151



P. 184



P. 226



P. 262

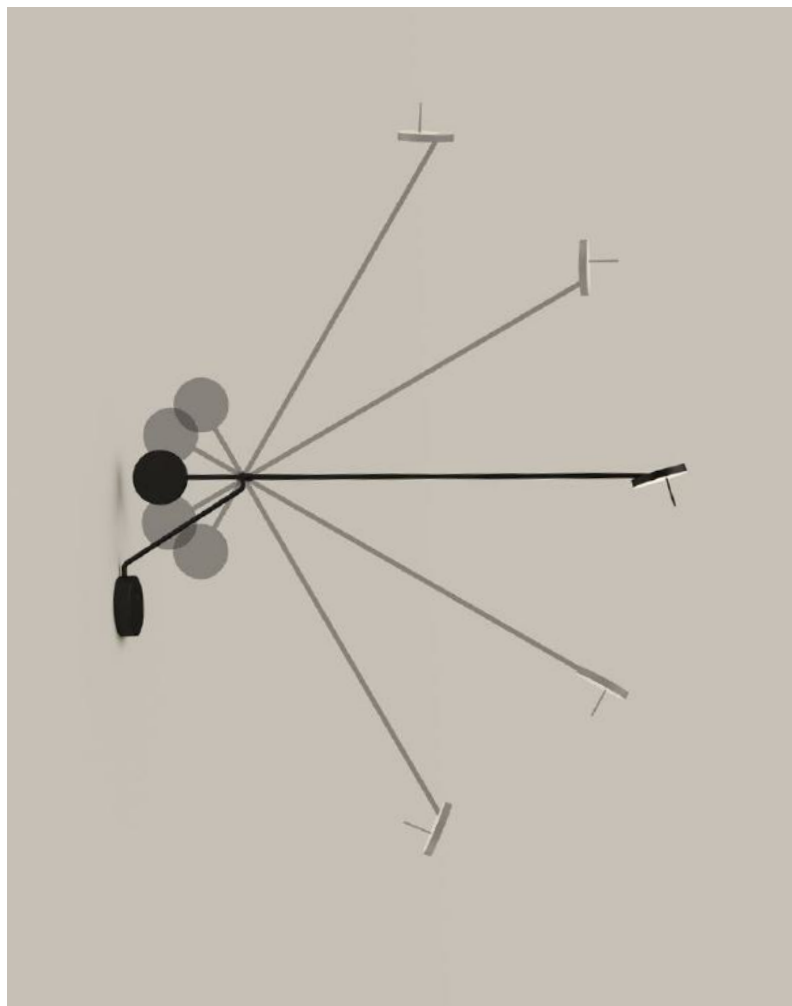

### Movimiento en equilibrio

Francesc Vilaró se ha inspirado en los móviles del escultor Alexander Calder para diseñar la colección, buscando el equilibrio entre las líneas que forman la estructura y su contrapeso. En esta composición de balances, la luz puede dirigirse a cualquier punto, proyectando una luz de acento de forma muy honesta, con una gran libertad de movimientos.

### Movimento em equilíbrio

Francesc Vilaró inspirou-se nos móveis do escultor Alexander Calder para criar a coleção, procurando um equilíbrio entre as linhas que formam a estrutura e o seu contrapeso. Nesta composição de equilíbrios, a luz pode ser dirigida para qualquer ponto, projetando uma luz de realce de uma forma muito honesta, com uma grande liberdade de movimentos.

La rotación del cabezal  
permite dirigir la luz.  
A rotação da cabeça  
permite dirigir a luz.



### Invisible Wall Fixture

QS

BODY MAT ST,AL	DIF MAT PMMA		 350°		 DIM
-------------------	-----------------	--	----------	--	---------

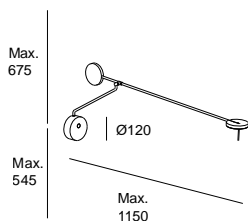

LED | CRI 92 | W Total 10.5

Negro Preto 05 ●

	K	Real Lm	Structure	Code
TOUCH DIMMING 100-240V	2700 3000	534 550	05 ● 05 ●	<b>05-7385-05-05</b> <b>05-5693-05-05</b>

QS Quick Service | 2-6 días laborables (tiempo de transporte no incluido)  
Quick Service | 2-6 dias úteis (tempo de transporte não incluido)

# Prolix



## Performance Universe



P. 154



P. 350

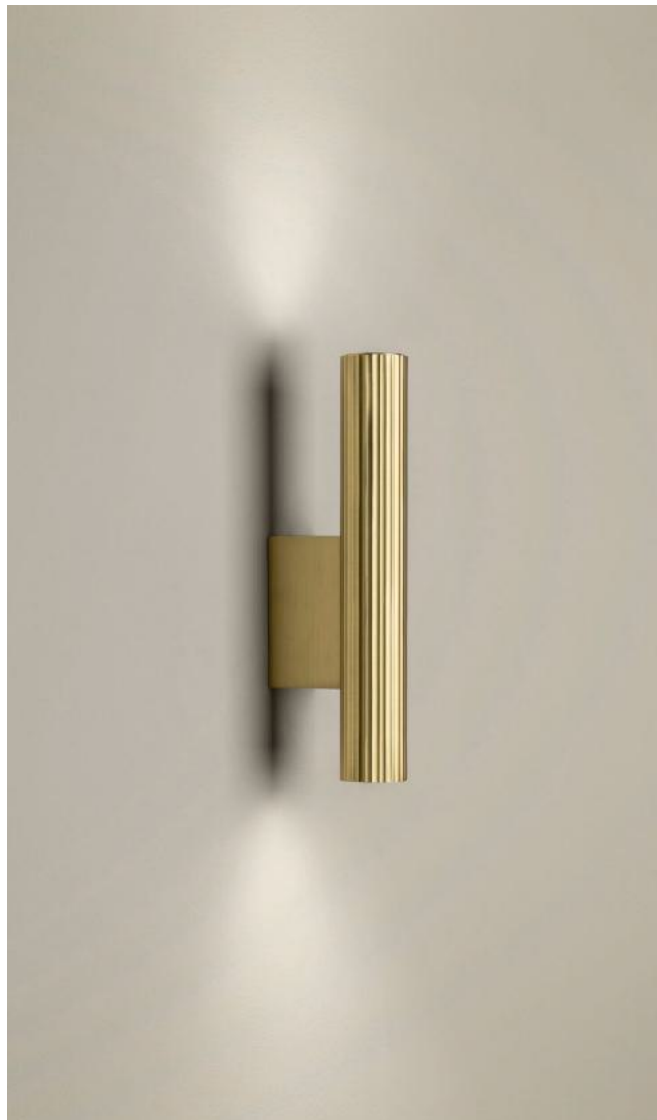

### Geometría lumínica

Prolix es un juego de geometrías estructurales y lumínicas que no deja nada al azar. Es una pieza que presume de una piel decorativa, con una silueta facetada y una elegancia innata. Este aplique de óptica bidireccional baña las paredes con luz superior e inferior para crear un efecto de luz armónico tanto en pasillos, como en zonas públicas donde se precisa de una luz ambiental confortable y cálida.

### Geometria lumínica

Prolix é um jogo de geometrias estruturais e lumínicas que não deixa nada ao acaso. É uma peça que ostenta uma pele decorativa, com uma silhueta facetada e uma elegância inata. Este aplique de ótica bidireccional banha as paredes com luz superior e inferior para criar um efeito de iluminação harmonioso tanto em corredores como em áreas públicas onde é necessária uma luz ambiente confortável e quente.



## Prolix

QS

BODY MAT	DIF MAT
AL	PMMA

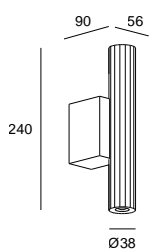
LED | K 2700 | CRI 92 | W Total 18.8 | Real Lm 358

Negro Preto 05 ●  
Oro mate Ouro mate DN ●



Structure

Code

PHASE CUT 220-240VAC

05 ●  
DN ●

05-8513-05-05  
05-8513-DN-DN

# Linea



## Essential Universe



### El clásico up&down cilíndrico llevado a su mínima expresión

Disponible en doble emisión y simple emisión, Linea ha nacido para ser un referente en el mercado en cuanto a apliques cilíndricos para áreas residenciales y hoteles que requieren funcionalidad y estética con un coste asequible. Su diseño ultra compacto, limpio y minimalista, así como su temperatura de color cálida 2700K, lo hacen adecuado para iluminar espacios tanto exteriores como interiores. Está disponible en acabados gris antracita y blanco.

### O clássico up&down cilíndrico levado à sua mínima expressão

Disponível em emissão dupla e emissão simples, Imo foi criado para ser uma referência no mercado em termos de apliques cilíndricos para áreas residenciais e hotéis que exigem funcionalidade e estética a um custo acessível. O seu design ultracompacto, limpo e minimalista e a temperatura de cor quente de 2700K tornam-na adequada para iluminar espaços interiores e exteriores. Está disponível nos acabamentos cinzento antracite e branco.

## Linea Single Emisión

NEW

QS

BODY MAT
AL

DIF MAT
PC



50000h
L80 B20

2
MacAdam

IP
54

IK
04

LOW
FLICKER

SEA SIDE
SUITABLE



Gris urbano Cinzento urbano Z5 ●  
Blanco Branco 14 ○

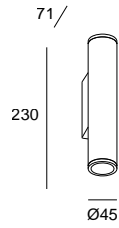

### LED

K	CRI	W Total	Real Lm	Optics	Code	
2700	80	2.8	237	18°	05-E209-	Z5 ● 14 ○ - CK ON-OFF 220-240V

## Linea Double Emisión

NEW

QS

BODY MAT
AL

DIF MAT
PC



50000h
L80 B20

2
MacAdam

IP
54

IK
04

LOW
FLICKER

SEA SIDE
SUITABLE



Gris urbano Cinzento urbano Z5 ●  
Blanco Branco 14 ○

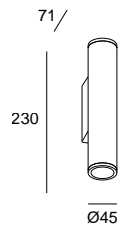

### LED

K	CRI	W Total	Real Lm	Optics	Code	
2700	80	5.4	488	18° + 18°	05-E210-	Z5 ● 14 ○ - CK ON-OFF 220-240V



# Veneto



## Performance Universe



P. 120



Difusor de metacrilato.  
Difusor de metacrilato.

Superficie de pared | Superfície de parede

### Veneto

QS

BODY MAT

DIF MAT



ST,AL

PMMA

Decorative Collection

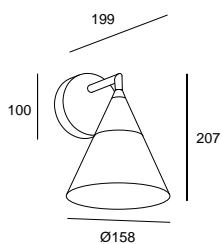

LED | K 2700 | CRI 80 | W Total 8.3 | Real Lm 452

Latón pulido Latão polido DO



ON-OFF 100-277V

Structure

Code

DO

05-7588-DO-DO

# Big Bang



Performance Universe



## Protagonismo de día y de noche

La forma circular de los componentes de Big Bang y sus acabados blanco texturizado y dorado en el centro, consiguen que la pieza transmita sensaciones tanto apagada como encendida. Apagada decora la estancia con la armonía de sus formas y cuando se enciende genera una luz indirecta con un halo lumínico muy especial que no pasa desapercibido.

## Protagonismo de dia e de noite

A forma circular dos componentes do Big Bang e os seus acabamentos branco texturizado e dourado no centro fazem com que a peça transmita sensações tanto desligada como quando acesa. Desligada, decora a divisão com a harmonia das suas formas e quando se acende gera uma luz indireta com um feixe lumínico muito especial que não passa despercebido.

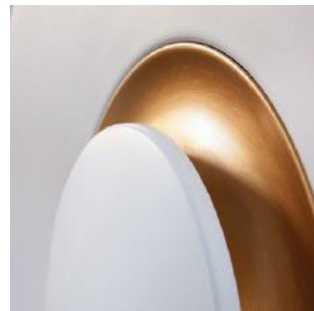

### Big Bang

QS

BODY MAT	DIF MAT	
AL	PMMA	

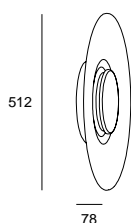

LED | K 3000 | CRI 92 | W Total 25 | Real Lm 760

Blanco Branco BW



ON-OFF 100-240V

Structure

Code

BW

05-5085-BW-BW

# Attic



## Performance Universe



P. 129



### Riqueza compositiva

Attic es un sistema de iluminación extremadamente funcional gracias a la gran facilidad de instalación y adición de luminarias. La luz de sus bombillas puede plantearse tanto para zonas de trabajo como para crear ambientes relajados. Además, el efecto lumínico que generan las aperturas laterales de la pantalla proporciona una integración total de la estructura del cableado en la composición final de la pieza. Con posibilidad de personalización del color de las pantallas y tres formas geométricas combinables entre ellas, Attic es una pieza modular en todos los sentidos.

### Riqueza compositiva

O Attic é um sistema de iluminação extremamente funcional graças à grande facilidade de instalação e de adição de luminárias. A luz das suas lâmpadas pode ser utilizada tanto para zonas de trabalho como para criar ambientes descontraídos. Além disso, o efeito lumínico gerado pelas aberturas laterais do abajur permite uma integração total da estrutura de cablagem na composição final da peça. Com a possibilidade de personalizar a cor dos abajures e três formas geométricas combináveis entre si, Attic é uma peça modular em todos os sentidos.



# Configura tu Attic

## Configure a sua Attic



Configurator for customisation available.  
 Configurateur de personnalisation disponible.  
[attic.ledsc4.com](http://attic.ledsc4.com)

### 1 Instalación

#### Installation

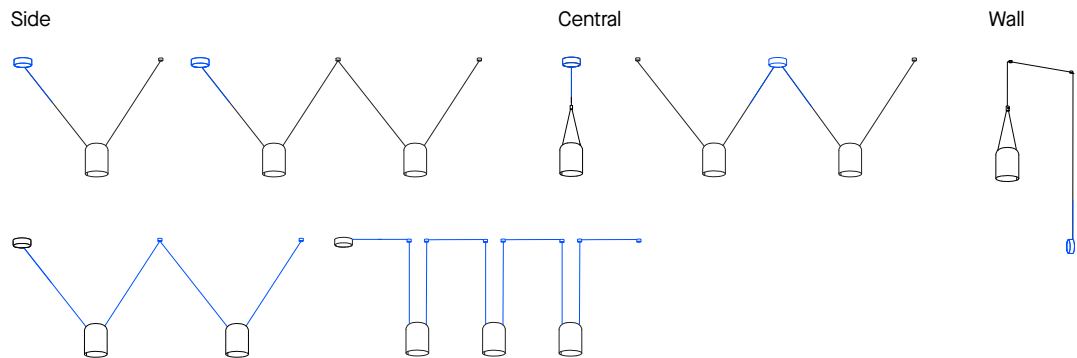

#### Con 2 opciones de instalación

#### Con 2 opções de instalação

No hay opciones de instalación para el modelo individual con florón central.  
 Não disponível para o modelo individual com roseta central.

### 2 Longitud de cable

#### Comprimento do cabo

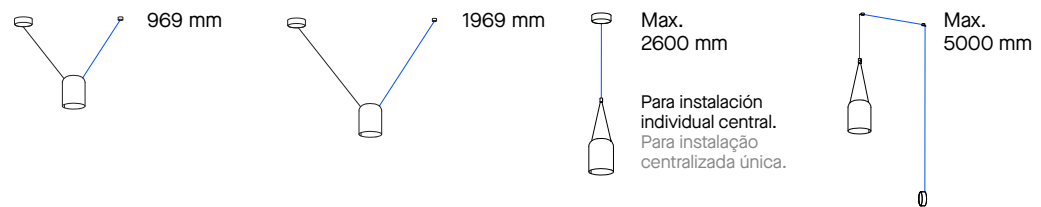

### 3 Pantalla

#### Quebra-luz



### 4 Combinaciones estandar

#### Combinações standard

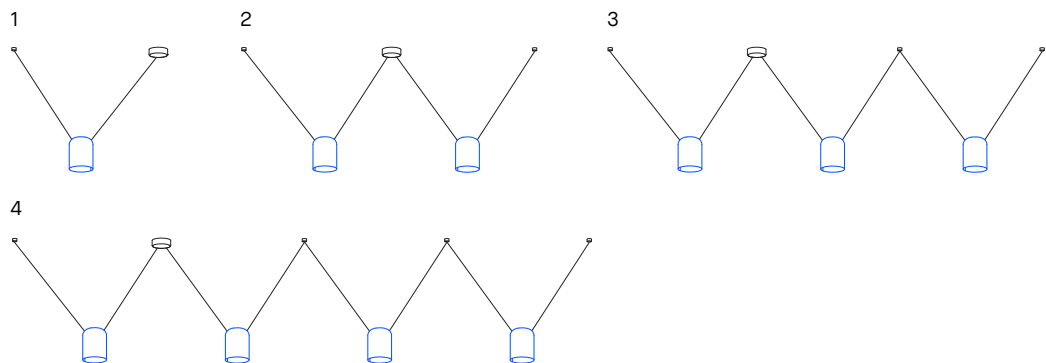

Más opciones a través del configurador.  
 Mais opções através do configurador.

### 4 Acabados

#### Acabamentos



Múltiples colores personalizables bajo petición.  
 Várias cores personalizáveis a pedido.



## Attic Rectangular Shape

QS

BODY MAT	
AL	

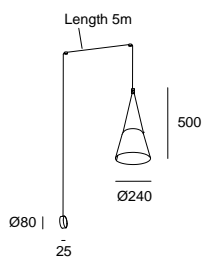

E27 | W Max. 15

Blanco Branco 14

Negro Preto 05

Structure	Exterior Screen	Code
05	05	<b>05-7388-05-05</b>
05	14	<b>05-7388-05-14</b>
05	05	<b>05-7389-05-05</b>
05	14	<b>05-7389-05-14</b>
05	05	<b>05-9007-05-05</b>
05	14	<b>05-9007-05-14</b>

\*Bombilla no incluida.  
\*Lâmpada não incluída.

# Super Attic



Performance Universe



P. 136



## Presencia y personalidad

Super Attic se adueña sin complejos del protagonismo del ambiente. Su pantalla cónica de grandes dimensiones emite un haz de luz con una destacada presencia, aportando personalidad al espacio.

## Presença e personalidade

Super Attic assume sem complexos o protagonismo do ambiente. O seu quebra-luz cónico de grandes dimensões emite um feixe de luz com uma presença de destaque, dando personalidade ao espaço.

# Configura tu Attic Configure a sua Attic



Configurator for customisation available.  
Configurateur de personnalisation disponible.  
[attic.ledsc4.com](http://attic.ledsc4.com)

## 1 Instalación Installation

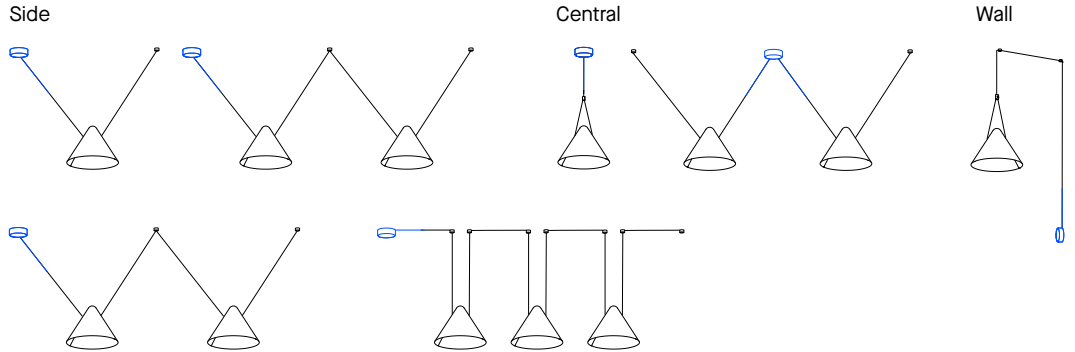

Con 2 opciones de instalación  
Con 2 opções de instalação

No hay opciones de instalación para el modelo individual con florón central.  
Não disponível para o modelo individual com roseta central.

## 2 Longitud de cable Comprimento do cabo

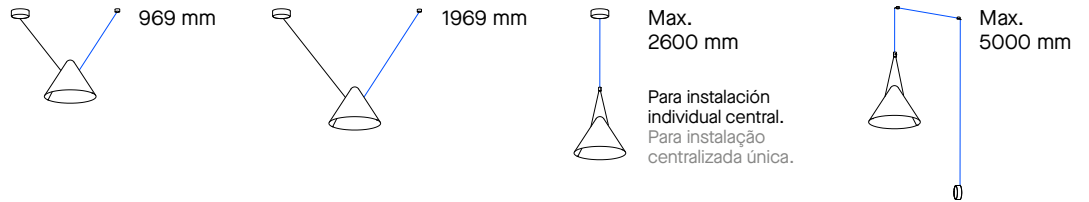

## 3 Combinaciones estandar Combinações standard

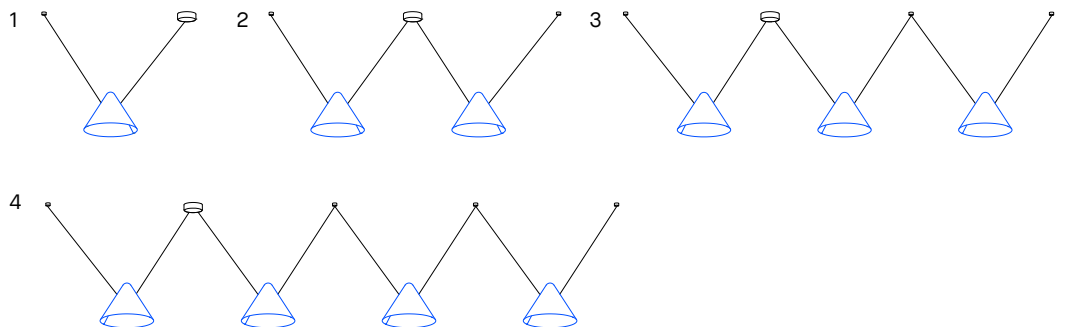

Más opciones a través del configurador.  
Mais opções através do configurador.

## 4 Acabados Acabamentos

05 Black

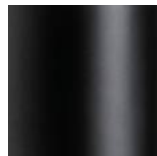

Múltiples colores personalizables bajo petición.  
Várias cores personalizáveis a pedido.

## Super Attic

QS

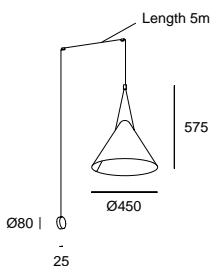
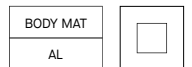

E27 | W Max. 15

Negro Preto 05 ●

Structure Exterior Screen

Code

05 ● 05 ●

05-8348-05-05

\*Bombilla no incluida.  
\*Lâmpada não incluída.

# H



## Performance Universe



P. 140



P. 216



P. 258



### Distinción natural

De líneas simples y puras, el diseño H de Benedito aporta una elegancia natural al espacio que habita. Con opción de instalación empotrada o en superficie, H destaca en el ambiente por la calidez de su luz y por el juego de sombras que produce la delicada apertura superior en la pieza.

### Distinção natural

De linhas simples e puras, o design H de Benedito traz uma elegância natural ao espaço. Com opção de instalação encastrada ou na superfície, H destaca-se no ambiente pela calidez da sua luz e pelo jogo de sombras que a delicada abertura superior na peça produz.



Dos opciones de empotrado.  
 Duas opções de encastrado.

Opción de aplique colgante con cordón embelezador (instalación eléctrica por pared).  
 Opção de aplique suspenso com cordão embelezador (instalação elétrica por parede).

H

QS

BODY MAT	DIF MAT	
ST	ACR	

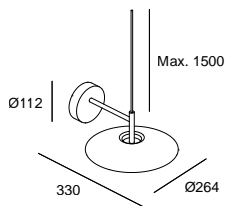

LED | K 2700 | CRI 92 | W Total 17 | Real Lm 627

Negro Preto 05 ●  
 Oro mate Ouro mate DN ●



Structure

Code

ON-OFF 100-277V

05 ●  
 DN ●

05-7742-05-05  
 05-7742-DN-DN

# Organic



## Performance Universe



P. 229



P. 253



### Suave y armónica

El perfil de esta pieza, suave y armónica, se inspira en las formas orgánicas de las flores y las hojas. Su pantalla ligeramente curvada, con un interior dorado, se integra en el espacio de forma sutil y natural.

### Suave e harmonioso

O perfil desta peça, suave e harmónica, é inspirado nas formas orgânicas das flores e folhas. O seu quebra-luz ligeiramente curvo, com um interior dourado, integra-se no espaço de forma subtil e natural.

## Organic

QS

BODY MAT			
ST		355°	90°

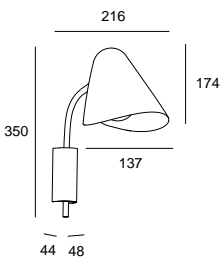

E14 | W Max. 9

Negro Preto 05 ●

Structure

Code

05 ●

05-7582-05-05

Acc. comunes no incluidos  
Ac. comuns não incluídos

Cable de conexión  
Cabo de ligação

71-7660-00-00

# MISO



## Essential Universe



P. 346



De líneas suaves y discretas, Miso es un plafón esencial que se adapta a todos los espacios. Con dos medidas disponibles, ofrece una enorme flexibilidad de acabados gracias a la combinación de colores de su estructura interior y exterior.

Com linhas suaves e discretas, Miso é um plafon essencial que se adapta a todos os espaços. Com duas medidas disponíveis, oferece uma enorme flexibilidade de acabamentos graças à combinação de cores da sua estrutura interior e exterior.

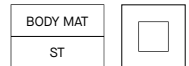

### Miso 285mm

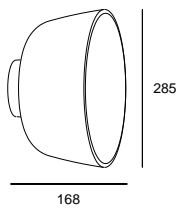

E27 | W Max. 15

Exterior Screen

Interior Screen

Code

- 05 ●
- 05 ●
- 14 ○
- 14 ○

- 14 ○
- DL ●
- 14 ○
- DL ●

15-8330-05-14  
 15-8330-05-DL QS  
 15-8330-14-14 QS  
 15-8330-14-DL

- Blanco Branco 14 ○
- Negro Preto 05 ●
- Oro Ouro DL ●

\*Bombilla no incluída.  
 \*Lâmpada não incluída.

### Miso 433mm

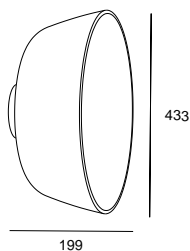

E27 | W Max. 15

Exterior Screen

Interior Screen

Code

- 05 ●
- 14 ○
- 14 ○

- DL ●
- 14 ○
- DL ●

15-8331-05-DL QS  
 15-8331-14-14 QS  
 15-8331-14-DL QS

- Blanco Branco 14 ○
- Negro Preto 05 ●
- Oro Ouro DL ●
- Gris piedra Cinzento pedra EM ●

\*Bombilla no incluída.  
 \*Lâmpada não incluída.

# Drone



## Performance Universe



Este aplique de medidas reducidas presenta múltiples opciones de acabados combinados en su versión doble o simple.

Este aplique de medidas reducidas apresenta múltiplas opções de acabamentos combinados na sua versão dupla ou simples.



### Drone Single

QS

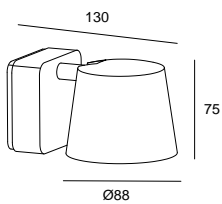

LED | K 2700 | CRI 80 | W Total 8.6 | Real Lm 350



ON-OFF 100-277V

Structure Interior Screen Code

14	○	06	●	<b>05-5306-14-06</b>
14	○	21	◐	<b>05-5306-14-21</b>
14	○	F5	◑	<b>05-5306-14-F5</b>
CI	●	06	●	<b>05-5306-CI-06</b>
CI	●	21	◐	<b>05-5306-CI-21</b>
CI	●	F5	◑	<b>05-5306-CI-F5</b>

BODY MAT  
AL

DIF MAT  
AL



355°

0° a 90°

Blanco Branco 14 ○  
Cromo Cromado 21 ◐

Oro Ouro F5 ◑  
Marrón Castanho CI ●  
Cobre Cobre 06 ●

### Drone Double

QS

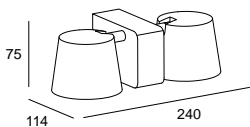

LED | K 2700 | CRI 80 | W Total 16.3 | Real Lm 613



ON-OFF 100-277V

Structure Interior Screen Code

14	○	06	●	<b>05-5307-14-06</b>
14	○	21	◐	<b>05-5307-14-21</b>
14	○	F5	◑	<b>05-5307-14-F5</b>
CI	●	06	●	<b>05-5307-CI-06</b>
CI	●	21	◐	<b>05-5307-CI-21</b>
CI	●	F5	◑	<b>05-5307-CI-F5</b>

BODY MAT  
AL

DIF MAT  
AL



355°

0° a 90°

Blanco Branco 14 ○  
Cromo Cromado 21 ◐

Oro Ouro F5 ◑  
Marrón Castanho CI ●  
Cobre Cobre 06 ●

# Vetro



## Performance Universe



P. 349



P. 370



Un clásico con un vidrio prensado de doble grosor especial.

Um clássico com um vidro prensado de dupla espessura especial.



## Vetro

QS

BODY MAT	DIF MAT		IP
ST	GLA		44

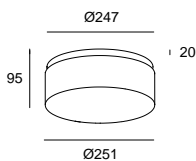

LED | K 3000 | CRI 80 | W Total 22.4 | Real Lm 1240

Blanco Branco 14   
Cristal pintado blanco interior G5   
Vidro pintado branco interior



ON-OFF 220-240V

Body

14

Difussor

G5

Code

05-7387-14-G5

# Nude



## Essential Universe



P. 231



P. 265



Instalación empotrada.  
instalação encastrada.

Instalación en superficie.  
Instalação de superfície.

### Nude

QS

BODY MAT		
AL		360°

Negro Preto 05 ●  
Oro mate Ouro mate DN ●

E27 | W Max. 15

Structure

Head

Code

05 ●  
05 ●

05 ●  
DN ●

**05-8515-05-05**  
**05-8515-05-DN**

\*Bombilla no incluida.  
\*Lâmpada não incluida.

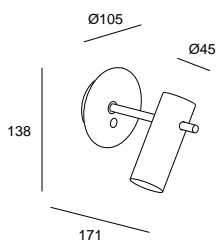

80 3-30 mm

QS Quick Service | 2-6 días laborables (tempo de transporte no incluido)  
Quick Service | 2-6 dias úteis (tempo de transporte não incluido)

# Metrica



## Essential Universe



P. 204



P. 236



P. 270



## Metrica Shade

QS

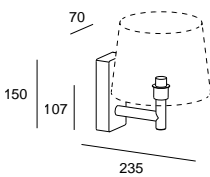
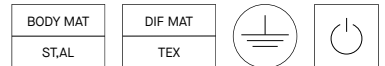

E27 | W Total Max. 15

Negro Preto 05 ●  
Níquel satinado Níquel acetinado 81 ●

### Structure

05 ●  
81 ●

### Code

05-8399-05-82  
05-8399-81-82

\*Bombilla no incluida.  
\*Lâmpada não incluída.

## No incluidos y requeridos

## Não incluído e requeridos

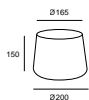

14 ○  
05 ●  
BY ●

**PAN-157-14**  
**PAN-157-05**  
**PAN-157-BY**

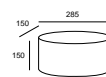

14 ○  
BY ●

**PAN-177-14**  
**PAN-177-BY**

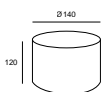

14 ○  
BY ●

**PAN-175-14**  
**PAN-175-BY**

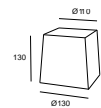

14 ○  
BY ●

**PAN-178-14**  
**PAN-178-BY**

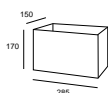

14 ○  
BY ●

**PAN-176-14**  
**PAN-176-BY**

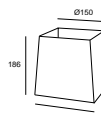

14 ○  
BY ●

**PAN-179-14**  
**PAN-179-BY**

QS Quick Service | 2-6 días laborables (tiempo de transporte no incluido)  
Quick Service | 2-6 dias úteis (tempo de transporte não incluído)

# Fino



Performance Universe

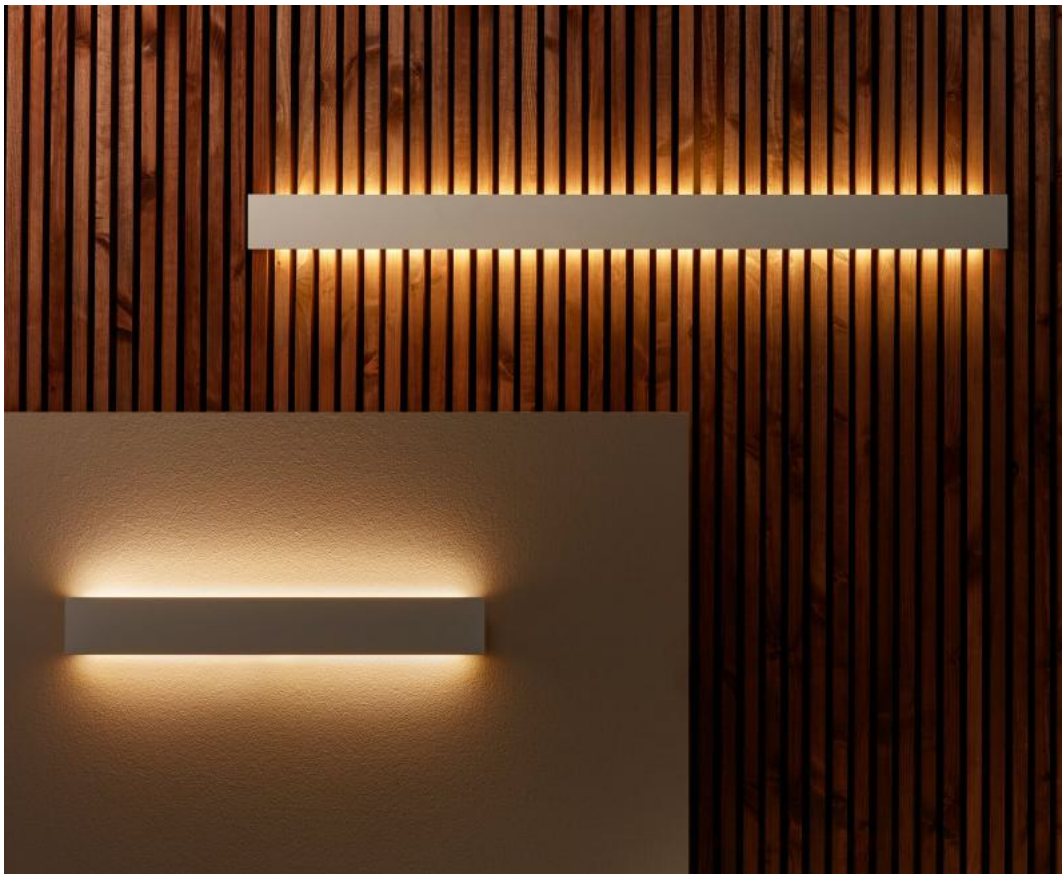

## Perfecta integración arquitectónica

Elegancia, tecnicidad y sofisticación con un diseño que se estructura en líneas rectas y ángulos perfectos.

## Perfeita integração arquitetónica

Elegância, tecnicidade e sofisticação com um design que se estrutura em linhas retas e ângulos perfeitos.



Doble emisión de luz.  
Dupla emissão de luz.

### Fino 540mm

BODY MAT	DIF MAT
AL	PMMA

Blanco Branco 14 ○  
Negro Preto 60 ●

LED | K 2700 | CRI 80 | W Total 13.2 | Real Lm 452

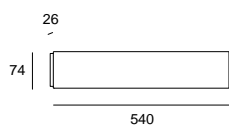

Structure

Code

ON-OFF 100-240V

14 ○  
60 ●

**05-7573-14-14**  
**05-7573-60-60**

1-10V 220-240V

14 ○  
60 ●

**05-7574-14-14**  
**05-7574-60-60**

### Fino 1040mm

BODY MAT	DIF MAT	
AL	PMMA	

Blanco Branco 14 ○  
Negro Preto 60 ●

LED | K 2700 | CRI 80 | W Total 24.6 | Real Lm 905

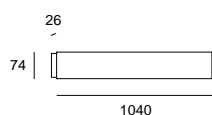

Structure

Code

ON-OFF 220-240V

14 ○  
60 ●

**05-7575-14-14**  
**05-7575-60-60**

1-10V 220-240V

14 ○  
60 ●

**05-7576-14-14**  
**05-7576-60-60**

# Duna



## Performance Universe

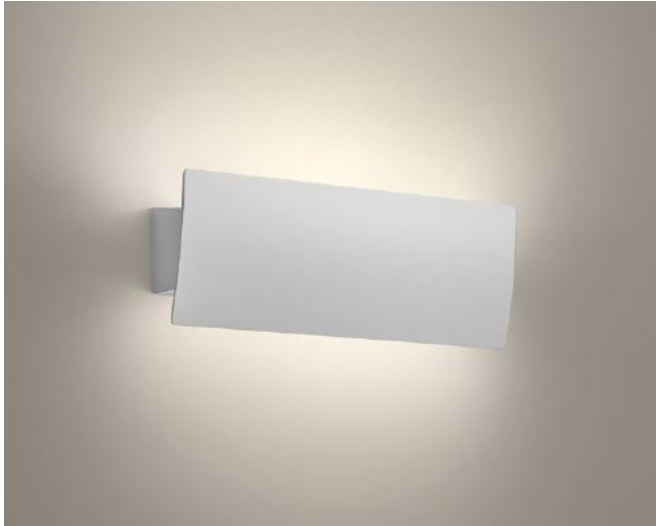

### Cálida y atemporal

Duna se adapta al espacio de forma discreta y elegante y se configura como una opción ideal para ofrecer una luz bidireccional funcional para cualquier escena.

### Acolhedor e intemporal

Duna adapta-se ao espaço de forma discreta e elegante e configura-se como uma opção ideal para oferecer uma luz bidireccional funcional para qualquer cenário.

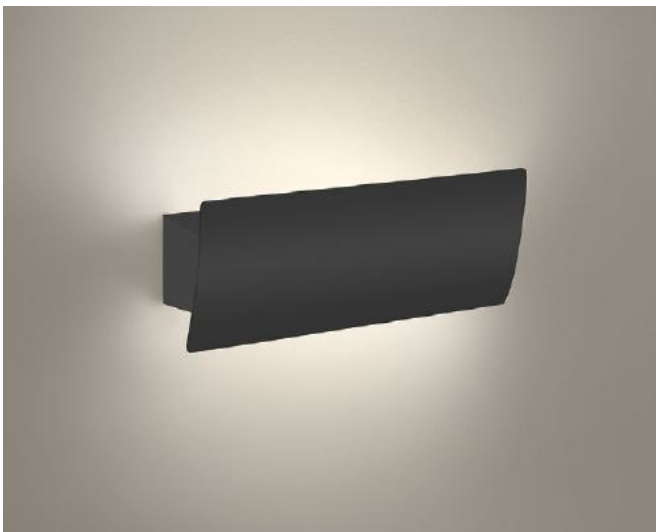

## Duna

QS

BODY MAT	DIF MAT	
AL	PMMA	

- Blanco Branco 14
- Negro Preto 60
- Blanco opal Branco opalino M1

LED | K 2700-3000-4000 | CRI 80 | W Total 27 | Real Lm 1841

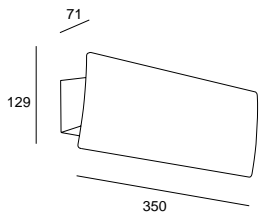

PHASE CUT 220-240V

Structure	Difussor	Code
14 <input type="radio"/>	M1 <input type="radio"/>	<b>05-A091-14-M1</b>
60 <input checked="" type="radio"/>	M1 <input type="radio"/>	<b>05-A091-60-M1</b>

# Lia



## Essential Universe

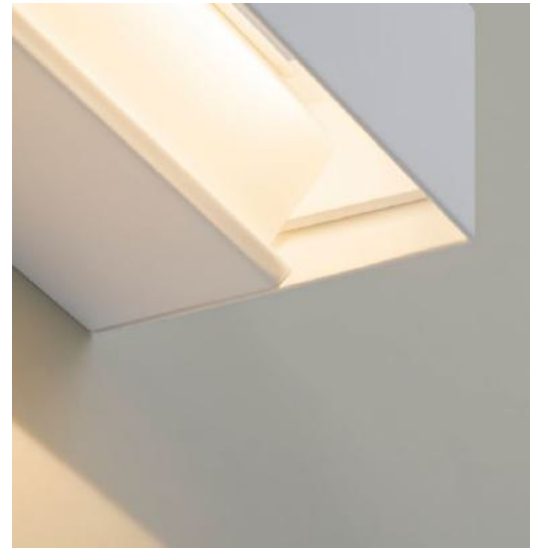

### Lia

QS

BODY MAT	DIF MAT		IP
AL	GLA		44

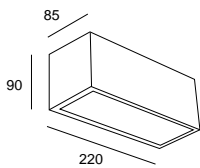

E27 | W Max. 15

Blanco Branco 14

Cristal satinado Vidro acetinado B8

**Structure**      **Difussor**

**Code**

14       B8

**05-4401-14-B8**

\*Bombilla no incluida.  
\*Lâmpada não incluída.

# Lia LED



Performance Universe



Aplique esencial en dos tamaños con doble emisión.

Aplique essencial em dois tamanhos com emissão dupla.





### Lia LED 250mm

NEW

QS

BODY MAT	DIF MAT	
ST	PC	

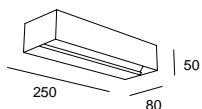

LED | K SW 2700-3000-4000K | CRI 92 | W Total 8.1 | Real Lm 475

Blanco Branco 14   
 Níquel satinado Níquel acetinado 81



Structure Code

ON-OFF 100-240V

14   
 81

05-A103-14-14  
 05-A103-81-81

### Lia LED 400mm

NEW

QS

BODY MAT	DIF MAT	
ST	PC	

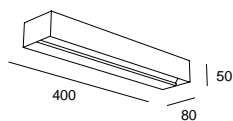

LED | K SW 2700-3000-4000K | CRI 92 | W Total 18.7 | Real Lm 1187

Blanco Branco 14   
 Níquel satinado Níquel acetinado 81



Structure Code

ON-OFF 220-240V

14   
 81

05-A104-14-14  
 05-A104-81-81

### Lia LED 600mm

NEW

QS

BODY MAT	DIF MAT	
ST	PC	

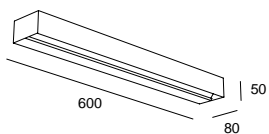

LED | K SW 2700-3000-4000K | CRI 92 | W Total 28.2 | Real Lm 1864

Blanco Branco 14   
 Níquel satinado Níquel acetinado 81



Structure Code

ON-OFF 200-240V

14   
 81

05-A105-14-14  
 05-A105-81-81

# Mini

Iluminación Up&amp;Down | Iluminação Up&amp;Down



## Essential Universe



### Perfecta para fachadas de reducidas dimensiones

La colección de apliques up&down Mini, como su nombre indica, es extremadamente compacta y está concebida para iluminar con estilo y calidez espacios reducidos como pequeñas terrazas, balcones y fachadas. Su valor principal es la versatilidad, ya que permite iluminar espacios tanto exteriores como interiores gracias al diseño atemporal y a la luz suave con temperatura de color 2700K. Está disponible en LED intergado y en portalámparas G9.

### Perfeita para pequenas fachadas

A coleção de apliques up&down Mini, como o seu nome indica, é extremamente compacta e foi concebida para iluminar com estilo e calidez espaços reduzidos, como pequenos terraços, varandas e fachadas. O seu principal valor é a versatilidade, uma vez que permite iluminar tanto espaços exteriores como interiores graças ao seu design intemporal e à luz suave com uma temperatura de cor de 2700K. Está disponível em LED interligado e em suporte de lâmpadas G9.



BODY MAT	DIF MAT		50000h	3
AL	PC		L80 B20	MacAdam

**Mini Cube**

NEW

QS

IP	IK	SEA SIDE
54	09	SUITABLE

Gris urbano Cinzento urbano Z5 ●  
Blanco Branco 14 ○

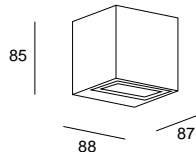
**LED**

K	CRI	W Total	Real Lm	Code	
2700	80	5.5	623	<b>05-E202-</b> Z5 ● 14 ○ - CK	ON-OFF 220-240V

**Mini Vertical**

NEW

QS

IP	IK	LOW	SEA SIDE
54	10	FLICKER	SUITABLE

Gris urbano Cinzento urbano Z5 ●  
Blanco Branco 14 ○

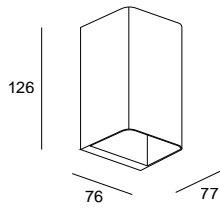
**GU9**

W	Code
Max. 6	<b>05-E203-</b> Z5 ● 14 ○ - M1

\*Bombilla no incluída.  
\*Lâmpada não incluída.

**Mini Horizontal**

NEW

QS

IP	IK	LOW	SEA SIDE	
54	10	FLICKER	SUITABLE	

Gris urbano Cinzento urbano Z5 ●  
Blanco Branco 14 ○

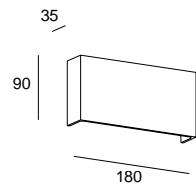
**LED**

K	CRI	W Total	Real Lm	Code	
2700	80	10.4	717	<b>05-E207-</b> Z5 ● 14 ○ - CK	ON-OFF 220-240V

# Cut NEW



## Essential Universe



### Perfecta para fachadas de reducidas dimensiones

Cut es el aplique perfecto cuando se busca algo más que un aplique up&down convencional. Su distintivo corte minimalista provoca un plus de personalidad y elegancia en las fachadas. Además, su diseño limpio, la tornillería oculta, la temperatura de color cálida y la disponibilidad en acabados gris antracita y blanco lo hace ideal para iluminar espacios tanto exteriores como interiores.

### Perfeito para fachadas pequenas

Cut é o aplique perfeito quando se procura algo mais do que um aplique up&down convencional. O seu corte minimalista distinto confere personalidade e elegância às fachadas. Além disso, o seu design limpo, as ferragens ocultas, a temperatura de cor quente e a disponibilidade nos acabamentos cinzento antracite e branco tornam-no ideal para iluminar espaços interiores e exteriores.

Superficie de pared | Superfície de parede

Decorative Collection

322

**Cut**  
**NEW**  
**QS**

BODY MAT AL	DIF MAT GLA		50000h L80 B20	3 MacAdam	IP 54	IK 04	SEA SIDE SUITABLE		
----------------	----------------	--	-------------------	--------------	----------	----------	----------------------	--	--

Gris urbano  Cinzento urbano Z5   
Blanco Branco 14

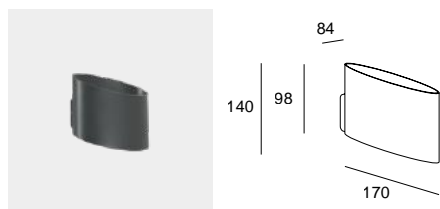

LED					
K	CRI	W Total	Real Lm	Code	
2700	80	9.8	688	<b>05-E206-</b> <input checked="" type="radio"/> Z5 <input type="radio"/> 14 <b>- CK</b>	ON-OFF 220-240V

**QS** Quick Service | 2-6 días laborables (tiempo de transporte no incluido)  
Quick Service | 2-6 dias úteis (tempo de transporte não incluído)



# Wilson

## Performance Universe



### Un plus de elegancia en todo tipo de paredes

El limpio diseño de Wilson, ligeramente redondeado y con la tornillería oculta; junto con su haz de luz definido y un sugerente juego de luces y sombras, hacen que esta colección sea muy valorada en proyectos que necesitan un plus de elegancia.

### Um plus de elegância em todo o tipo de paredes

O design limpo da Wilson, ligeiramente arredondado e com os parafusos ocultos, juntamente com o seu feixe de luz definido e um sugestivo jogo de luzes e sombras, tornam esta coleção altamente valorizada nos projetos que necessitam de um toque extra de elegância.

Cuenta con la posibilidad de cambiar el ángulo de salida de luz según las necesidades del espacio de forma rápida y sencilla (05-9683).  
Tem a possibilidade de alterar o ângulo de saída da luz de acordo com as necessidades do espaço de forma rápida e simples (05-9683).

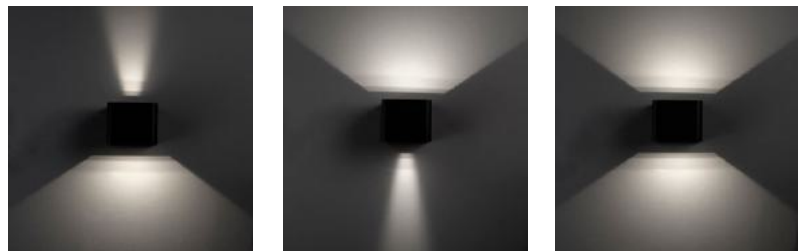

## Wilson Square

QS

BODY MAT AL	DIF MAT GLA		50000h L80 B20	3 MacAdam	IP 65	IK 08	SEA SIDE SUITABLE		
----------------	----------------	--	-------------------	--------------	----------	----------	----------------------	--	--

Gris urbano Cinzento urbano Z5 ●  
Blanco Branco 14 ○

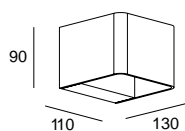

### LED

K	CRI	W Total	Real Lm	Code	
2700	80	10.2	602	05-9683 - Z5 ● 14 ○ - CK	ON-OFF 100-240V
3000	80	10.2	623	05-9683 - Z5 ● 14 ○ - CL	ON-OFF 100-240V

○ 34 ● J6 ● 60

\* Acabados The Colours. Consultar precios en tarifa y plazos de entrega con equipo comercial.  
\* Acabamentos The Colours. Consultar preços e prazos de entrega com a nossa equipa comercial.

# Ges



## Essential Universe



### Ges Rectangular 220mm

QS

BODY MAT  
PLSTER

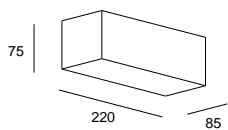

E14 | W Max. 9

Blanco Branco 14 ○

Structure

Code

14 ○

05-1793-14-14

### Ges Square

QS

BODY MAT  
PLSTER

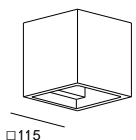

G9 | W Max. 6

Blanco Branco 14 ○

Structure

Code

14 ○

05-1794-14-14

# Ges Circular



Essential Universe

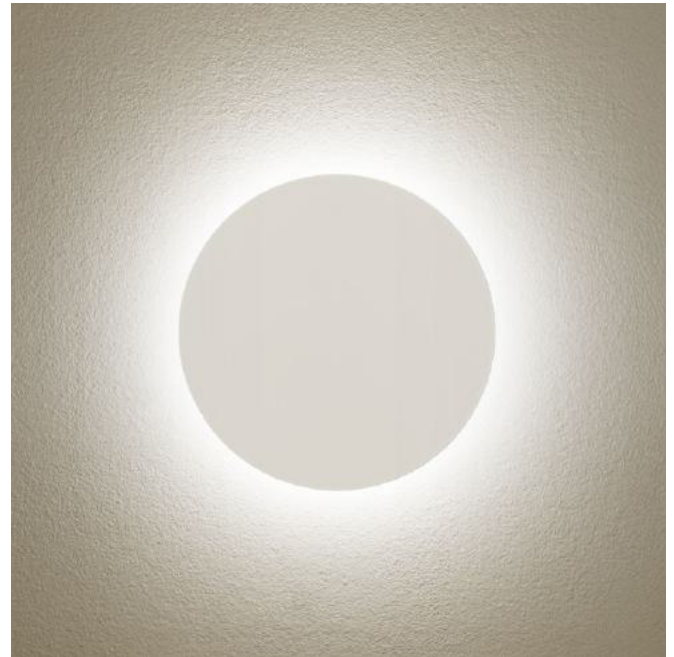
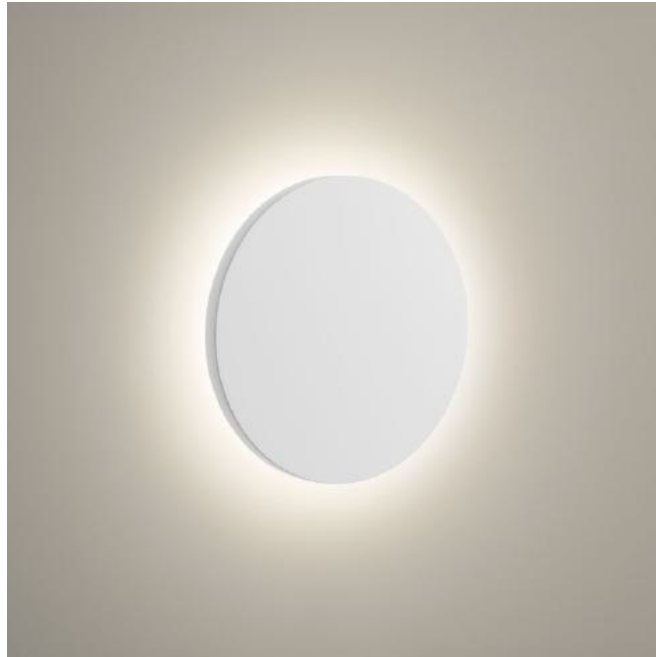

## La perfección del círculo

Ges representa la perfección del círculo en la mínima expresión. El halo de luz circular le confiere un efecto volátil y cálido a la vez.

## A perfeição do círculo

Ges representa a perfeição do círculo na expressão mínima. O feixe de luz circular dá-lhe um efeito volátil e acolhedor ao mesmo tempo.

### Ges Round Ø260mm

QS

BODY MAT	DIF MAT	
ST,PLSTER	ACR	

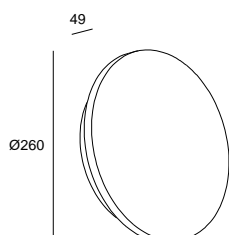

LED | K 2700-3000-4000 | CRI 90 | W Total 8.7 | Real Lm 535

Blanco Branco 14



Structure

Code

ON-OFF 100-240V

14

05-A088-14-14

# Superficie de techo

## Superfície de teto



Gong

332



Levels

328



Spark

340

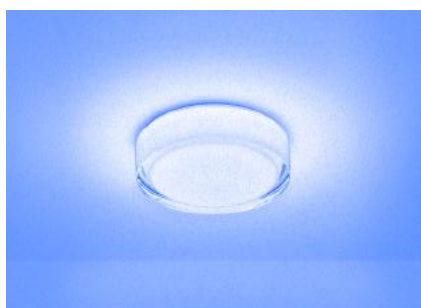

Vetro

349



Miso

346

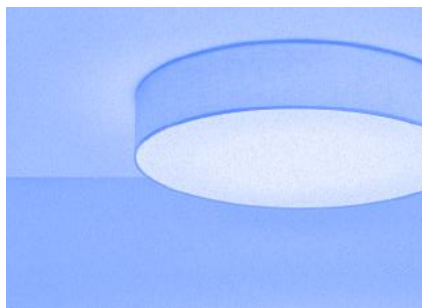

**Bol**

**348**

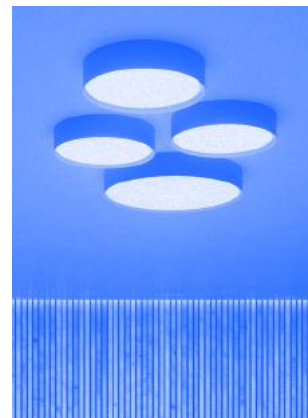

**Caprice**

**344**

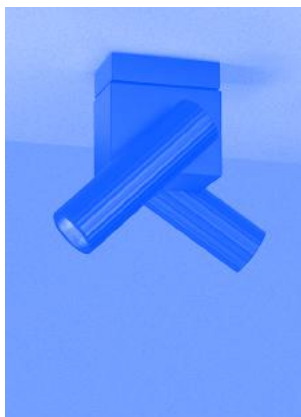

**Prolix**

**350**

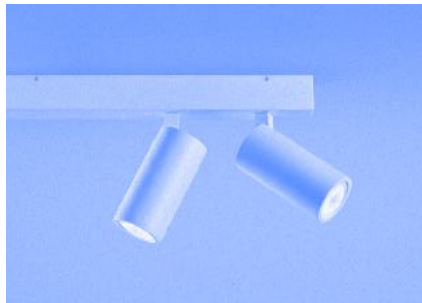

**Simply**

**353**



**Pipe**

**354**

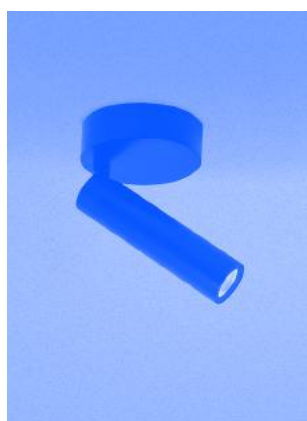

**Stylus**

**355**

# Levels



## Performance Universe



P. 086



P. 212



P. 250



### Una luz con gran carisma

La versión plafón de Levels es una estructura viva que crece y decrece en un juego orgánico de estructuras, niveles y densidades. Con tres acabados diferentes que se combinan con distintas opacidades de vidrio, la colección hace gala de un carisma innato que se adapta con facilidad a todos los espacios, tanto apagada como encendida.

### Uma luz com grande carisma

A versão plafon da Levels é uma estrutura viva que cresce e decrece num jogo orgânico de estruturas, níveis e densidades. Com três acabamentos diferentes que se combinam com diferentes opacidades de vidro, a coleção apresenta um carisma inato que se adapta com facilidade a todos os espaços, tanto ligada como desligada.



Vidrios con transparencias del 30% en el difusor pequeño, del 50% en el mediano y del 70% en el grande.

Vidros com transparências de 30% no difusor pequeno, de 50% no médio e de 70% no grande.



### Levels 1 Body Ø220mm

QS

BODY MAT
ST

DIF MAT
GLA



SWITCH CCT
2700-3000-4000

- Negro Preto 05 ●
- Verde Verde 08 ●
- Fumé Fumado 12 ●
- Âmbar Âmbar 15 ●

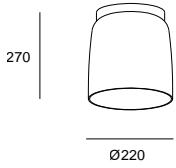

LED | K 2700-3000-4000 | CRI 92 | W Total 28 | Real Lm 2035 (3000K)

	Structure	Difussor	Code
PHASE CUT 220-240V	05 ●	08 ●	<b>15-A131-05-08</b>
	05 ●	12 ●	<b>15-A131-05-12</b>
	05 ●	15 ●	<b>15-A131-05-15</b>
DALI-2 110-277V	05 ●	08 ●	<b>15-A137-05-08</b>
	05 ●	12 ●	<b>15-A137-05-12</b>
	05 ●	15 ●	<b>15-A137-05-15</b>

### Levels 1 Body Ø320mm

QS

BODY MAT
ST

DIF MAT
GLA



SWITCH CCT
2700-3000-4000

- Negro Preto 05 ●
- Verde Verde 08 ●
- Fumé Fumado 12 ●
- Âmbar Âmbar 15 ●

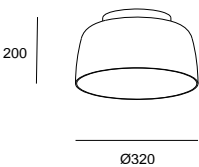

LED | K 2700-3000-4000 | CRI 92 | W Total 28 | Real Lm 2035 (3000K)

	Structure	Difussor	Code
PHASE CUT 220-240V	05 ●	08 ●	<b>15-A132-05-08</b>
	05 ●	12 ●	<b>15-A132-05-12</b>
	05 ●	15 ●	<b>15-A132-05-15</b>
DALI-2 110-277V	05 ●	08 ●	<b>15-A138-05-08</b>
	05 ●	12 ●	<b>15-A138-05-12</b>
	05 ●	15 ●	<b>15-A138-05-15</b>

### Levels 1 Body Ø420mm

QS

BODY MAT
ST

DIF MAT
GLA



SWITCH CCT
2700-3000-4000

- Negro Preto 05 ●
- Verde Verde 08 ●
- Fumé Fumado 12 ●
- Âmbar Âmbar 15 ●

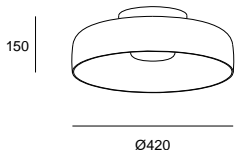

LED | K 2700-3000-4000 | CRI 92 | W Total 28 | Real Lm 2035 (3000K)

	Structure	Difussor	Code
PHASE CUT 220-240V	05 ●	08 ●	<b>15-A133-05-08</b>
	05 ●	12 ●	<b>15-A133-05-12</b>
	05 ●	15 ●	<b>15-A133-05-15</b>
DALI-2 110-277V	05 ●	08 ●	<b>15-A139-05-08</b>
	05 ●	12 ●	<b>15-A139-05-12</b>
	05 ●	15 ●	<b>15-A139-05-15</b>

## Levels 2 Bodies Ø320mm + Ø220mm

QS

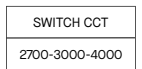
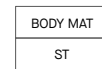

Negro Preto 05 ●  
Verde Verde 08 ●  
Fumé Fumado 12 ●  
Ámbar Âmbar 15 ●

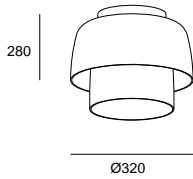

LED | K 2700-3000-4000 | CRI 92 | W Total 28 | Real Lm 2035 (3000K)

	Structure	Difussor	Code
PHASE CUT 220-240V	05 ●	08 ●	<b>15-A134-05-08</b>
	05 ●	12 ●	<b>15-A134-05-12</b>
	05 ●	15 ●	<b>15-A134-05-15</b>
DALI-2 110-277V	05 ●	08 ●	<b>15-A140-05-08</b>
	05 ●	12 ●	<b>15-A140-05-12</b>
	05 ●	15 ●	<b>15-A140-05-15</b>

## Levels 2 Bodies Ø420mm + Ø320mm

QS

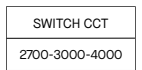
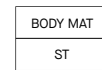

Negro Preto 05 ●  
Verde Verde 08 ●  
Fumé Fumado 12 ●  
Ámbar Âmbar 15 ●

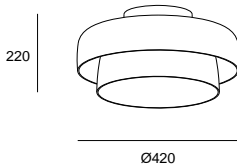

LED | K 2700-3000-4000 | CRI 92 | W Total 28 | Real Lm 2035 (3000K)

	Structure	Difussor	Code
PHASE CUT 220-240V	05 ●	08 ●	<b>15-A135-05-08</b>
	05 ●	12 ●	<b>15-A135-05-12</b>
	05 ●	15 ●	<b>15-A135-05-15</b>
DALI-2 110-277V	05 ●	08 ●	<b>15-A141-05-08</b>
	05 ●	12 ●	<b>15-A141-05-12</b>
	05 ●	15 ●	<b>15-A141-05-15</b>

## Levels 3 Bodies Ø420mm + Ø320mm + Ø220mm

QS

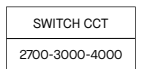
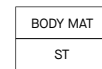

Negro Preto 05 ●  
Verde Verde 08 ●  
Fumé Fumado 12 ●  
Ámbar Âmbar 15 ●

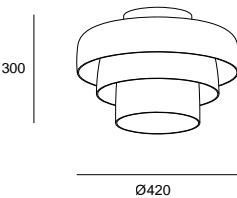

LED | K 2700-3000-4000 | CRI 92 | W Total 28 | Real Lm 2035 (3000K)

	Structure	Difussor	Code
PHASE CUT 220-240V	05 ●	08 ●	<b>15-A136-05-08</b>
	05 ●	12 ●	<b>15-A136-05-12</b>
	05 ●	15 ●	<b>15-A136-05-15</b>
DALI-2 110-277V	05 ●	08 ●	<b>15-A142-05-08</b>
	05 ●	12 ●	<b>15-A142-05-12</b>
	05 ●	15 ●	<b>15-A142-05-15</b>

\*Los acabados y tonalidad mostrados pueden no ser completamente precisos debido a ligeras variaciones en la producción, factores de iluminación, fotográficas e impresión.

\*Os acabamentos e tonalidades apresentados podem não ser totalmente precisos, devido a ligeiras variações na produção, fatores de iluminação fotográfica e de impressão.

# Gong



Performance Universe



P. 104



## Calidez y luz ambiental: pureza e innovación en el uso de materiales

Gong es una luminaria que sorprende, apropiándose de los espacios con una luz tamizada que se filtra de forma sugerente a través del tejido de su campana. Carisma y honestidad definen este diseño de Francesc Vilaró. Además de aportar una sensibilidad especial jugando con la vista y el tacto, el diseño de Gong está pensado para ofrecer un alto rendimiento lumínico en un cuerpo decorativo. Con tres acabados estándar y opciones personalizadas de tejido bajo pedido, Gong destaca por su carácter único, tanto si está encendida como apagada.

## Calor e luz ambiente: pureza e inovação na utilização dos materiais

Gong é uma luminária que surpreende, apropriando-se dos espaços com uma luz que é filtrada de forma sugestiva através do tecido da sua campânula. Carisma e honestidade definem este design Francesc Vilaró. Além de proporcionar uma sensibilidade especial jogando com a visão e o tato, o design de Gong destinase a oferecer um alto rendimento lumínico num corpo decorativo. Com três acabamentos standard e opções de tecido personalizadas sob pedido, Gong destaca-se pelo seu carácter único, quer esteja ligada ou desligada.





El alma de Gong reside en su tejido, un material artesanal y duradero, resistente a la abrasión e ignífugo.

A alma de Gong reside no seu tecido, um material artesanal, duradouro, resistente à abrasão e ignífugo.

Gong se presenta en tres acabados inspirados en la naturaleza —arena, terracota y carbón— con marco metálico a juego para una imagen homogénea y elegante. Además, ofrece tejido personalizado bajo pedido.

Gong está disponível em três acabamentos inspirados na natureza – areia, carvão e terracota – com uma estrutura metálica a condizer para uma imagem homogénea e elegante. Oferece também tecido personalizado mediante pedido.



Beige Arena  
Bege Areia



Terracota  
Terracota

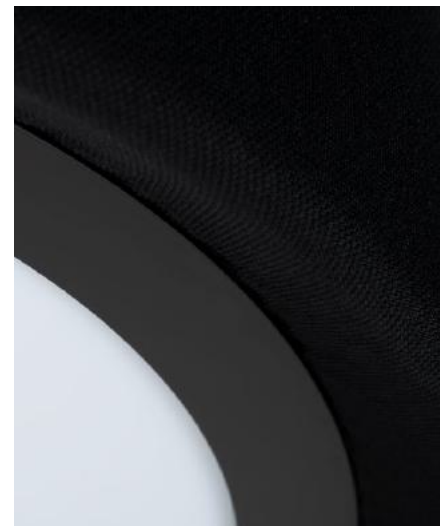

Negro Carbón  
Preto Carvão

Posibilidad de modificar la temperatura de color mediante un switch CCT.

A temperatura da cor pode ser alterada através de um switch CCT.



2700K



3000K



4000K

Gong incorpora difusor opal y microprismático que garantiza un control lumínico y el máximo confort visual.

Gong incorpora um difusor opalino e microprismático que garante o controlo lumínico e o máximo conforto visual.

Opal  
OpalinoMicroprismático  
Microprismático



Gong incorpora dos nuevas medidas y ofrece ahora tres tamaños —Ø340, Ø600 y Ø1000 mm— disponibles en versión colgante o plafón.

Gong incorpora duas novas medidas e ofrece agora três tamanhos – Ø340, Ø600 e Ø1000 mm – disponíveis nas versões de suspensão ou plafon.

## Gong Ø340 Microprisma

BODY MAT	DIF MAT
ST	PMMA



181

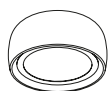

Ø342

LED | CRI 92 | W Totals 18.7

	K	Real Lm	Ring	Screen	Code
PHASE CUT 220-240V	2700	1263	FB	FA	<b>15-A350-FB-FA</b>
			W1	L1	<b>15-A350-W1-L1</b>
			60	EZ	<b>15-A350-60-EZ</b>
DALI-2 / PUSH 220-240V	2700	1263	FB	FA	<b>15-A351-FB-FA</b>
			W1	L1	<b>15-A351-W1-L1</b>
			60	EZ	<b>15-A351-60-EZ</b>
PHASE CUT 220-240V	3000	1306	FB	FA	<b>15-A352-FB-FA</b>
			W1	L1	<b>15-A352-W1-L1</b>
			60	EZ	<b>15-A352-60-EZ</b>
DALI-2 / PUSH 220-240V	3000	1306	FB	FA	<b>15-A353-FB-FA</b>
			W1	L1	<b>15-A353-W1-L1</b>
			60	EZ	<b>15-A353-60-EZ</b>
PHASE CUT 220-240V	4000	1342	FB	FA	<b>15-A354-FB-FA</b>
			W1	L1	<b>15-A354-W1-L1</b>
			60	EZ	<b>15-A354-60-EZ</b>
DALI-2 / PUSH 220-240V	4000	1342	FB	FA	<b>15-A355-FB-FA</b>
			W1	L1	<b>15-A355-W1-L1</b>
			60	EZ	<b>15-A355-60-EZ</b>

## Gong Ø340 Opal

BODY MAT	DIF MAT
ST	PMMA



181

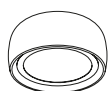

Ø342

LED | CRI 92 | W Totals 15

	K	Real Lm	Ring	Screen	Code
PHASE CUT 220-240V	2700	816	FB	FA	<b>15-A356-FB-FA</b>
			W1	L1	<b>15-A356-W1-L1</b>
			60	EZ	<b>15-A356-60-EZ</b>
DALI-2 / PUSH 220-240V	2700	816	FB	FA	<b>15-A357-FB-FA</b>
			W1	L1	<b>15-A357-W1-L1</b>
			60	EZ	<b>15-A357-60-EZ</b>
PHASE CUT 220-240V	3000	843	FB	FA	<b>15-A358-FB-FA</b>
			W1	L1	<b>15-A358-W1-L1</b>
			60	EZ	<b>15-A358-60-EZ</b>
DALI-2 / PUSH 220-240V	3000	843	FB	FA	<b>15-A359-FB-FA</b>
			W1	L1	<b>15-A359-W1-L1</b>
			60	EZ	<b>15-A359-60-EZ</b>
PHASE CUT 220-240V	4000	865	FB	FA	<b>15-A360-FB-FA</b>
			W1	L1	<b>15-A360-W1-L1</b>
			60	EZ	<b>15-A360-60-EZ</b>
DALI-2 / PUSH 220-240V	4000	865	FB	FA	<b>15-A361-FB-FA</b>
			W1	L1	<b>15-A361-W1-L1</b>
			60	EZ	<b>15-A361-60-EZ</b>

Los acabados y tonalidad mostrados pueden no ser completamente precisos debido a ligeras variaciones en la producción, factores de iluminación fotográficas e impresión.

Os acabamentos e tonalidades apresentados podem não ser totalmente precisos, devido a ligeiras variações na produção, fatores de iluminação fotográfica e de impressão.

Gris Seda	Cinzeno Seda	FB	
Tejido Crema	Tecido Creme	FA	
Marrón Caoba	Castanho Caoba	W1	
Terracota jaspeado	Terracota jaspeado	L1	
	Negro Preto	60	
	Tejido Negro	Tecido Preto	EZ

## Gong Ø600 Microprisma

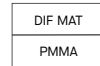

LED | CRI 92

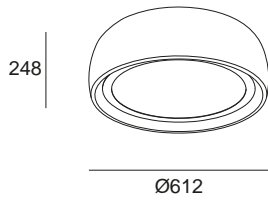

	K	W Total / Real Lm	Ring	Screen	Code
 PHASE CUT 220-240V	2700	34.7W / 2088lm	FB	FA	<b>15-8902-FB-FA</b>
			W1	L1	<b>15-8902-W1-L1</b>
			60	EZ	<b>15-8902-60-EZ</b>
DALI-2 / PUSH 220-240V	2700	36.5W / 2570lm	FB	FA	<b>15-A366-FB-FA</b>
			W1	L1	<b>15-A366-W1-L1</b>
			60	EZ	<b>15-A366-60-EZ</b>
PHASE CUT 220-240V	3000	34.7W / 2088lm	FB	FA	<b>15-8933-FB-FA</b>
			W1	L1	<b>15-8933-W1-L1</b>
			60	EZ	<b>15-8933-60-EZ</b>
DALI-2 / PUSH 220-240V	3000	36.5W / 2660lm	FB	FA	<b>15-A367-FB-FA</b>
			W1	L1	<b>15-A367-W1-L1</b>
			60	EZ	<b>15-A367-60-EZ</b>
PHASE CUT 220-240V	4000	34.7W / 2088lm	FB	FA	<b>15-8953-FB-FA</b>
			W1	L1	<b>15-8953-W1-L1</b>
			60	EZ	<b>15-8953-60-EZ</b>
DALI-2 / PUSH 220-240V	4000	36.5W / 2731lm	FB	FA	<b>15-A368-FB-FA</b>
			W1	L1	<b>15-A368-W1-L1</b>
			60	EZ	<b>15-A368-60-EZ</b>

## Gong Ø600 Opal

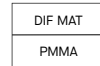

LED | CRI 92

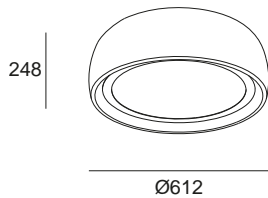

	K	W Total / Real Lm	Ring	Screen	Code
 PHASE CUT 220-240V	2700	34.7W / 1605lm	FB	FA	<b>15-A294-FB-FA</b>
			W1	L1	<b>15-A294-W1-L1</b>
			60	EZ	<b>15-A294-60-EZ</b>
DALI-2 / PUSH 220-240V	2700	36.5W / 1946lm	FB	FA	<b>15-A297-FB-FA</b>
			W1	L1	<b>15-A297-W1-L1</b>
			60	EZ	<b>15-A297-60-EZ</b>
PHASE CUT 220-240V	3000	34.7W / 1605lm	FB	FA	<b>15-A295-FB-FA</b>
			W1	L1	<b>15-A295-W1-L1</b>
			60	EZ	<b>15-A295-60-EZ</b>
DALI-2 / PUSH 220-240V	3000	36.5W / 2017lm	FB	FA	<b>15-A298-FB-FA</b>
			W1	L1	<b>15-A298-W1-L1</b>
			60	EZ	<b>15-A298-60-EZ</b>
PHASE CUT 220-240V	4000	34.7W / 1605lm	FB	FA	<b>15-A296-FB-FA</b>
			W1	L1	<b>15-A296-W1-L1</b>
			60	EZ	<b>15-A296-60-EZ</b>
DALI-2 / PUSH 220-240V	4000	36.5W / 2069lm	FB	FA	<b>15-A299-FB-FA</b>
			W1	L1	<b>15-A299-W1-L1</b>
			60	EZ	<b>15-A299-60-EZ</b>

Los acabados y tonalidad mostrados pueden no ser completamente precisos debido a ligeras variaciones en la producción, factores de iluminación fotográficas e impresión.

Os acabamentos e tonalidades apresentados podem não ser totalmente precisos, devido a ligeiras variações na produção, fatores de iluminação fotográfica e de impressão.

Gris Seda Cinzento Seda	FB
Tejido Crema Tecido Creme	FA
Marrón Caoba Castanho Caoba	W1
Terracota jaspeado Terracota jaspeado	L1
Negro Preto	60
Tejido Negro Tecido Preto	EZ

## Gong Ø1000 Microprisma

BODY MAT	DIF MAT
ST	PMMA



LED | CRI 92 | W Total 40

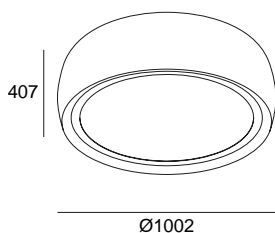

	K	Real Lm	Ring	Screen	Code
PHASE CUT 220-240V	2700	3193	FB	FA	<b>15-A338-FB-FA</b> <b>QS</b>
			W1	L1	<b>15-A338-W1-L1</b> <b>QS</b>
			60	EZ	<b>15-A338-60-EZ</b> <b>QS</b>
DALI-2 / PUSH 220-240V	2700	3193	FB	FA	<b>15-A339-FB-FA</b>
			W1	L1	<b>15-A339-W1-L1</b>
			60	EZ	<b>15-A339-60-EZ</b>
PHASE CUT 220-240V	3000	3261	FB	FA	<b>15-A340-FB-FA</b> <b>QS</b>
			W1	L1	<b>15-A340-W1-L1</b> <b>QS</b>
			60	EZ	<b>15-A340-60-EZ</b> <b>QS</b>
DALI-2 / PUSH 220-240V	3000	3261	FB	FA	<b>15-A341-FB-FA</b>
			W1	L1	<b>15-A341-W1-L1</b>
			60	EZ	<b>15-A341-60-EZ</b>
PHASE CUT 220-240V	4000	3342	FB	FA	<b>15-A342-FB-FA</b> <b>QS</b>
			W1	L1	<b>15-A342-W1-L1</b> <b>QS</b>
			60	EZ	<b>15-A342-60-EZ</b> <b>QS</b>
DALI-2 / PUSH 220-240V	4000	3342	FB	FA	<b>15-A343-FB-FA</b>
			W1	L1	<b>15-A343-W1-L1</b>
			60	EZ	<b>15-A343-60-EZ</b>

## Gong Ø1000 Opal

BODY MAT	DIF MAT
ST	PMMA



LED | CRI 92 | W Total 40

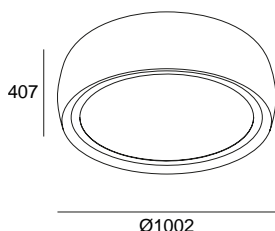

	K	Real Lm	Ring	Screen	Code
PHASE CUT 220-240V	2700	2341	FB	FA	<b>15-A344-FB-FA</b> <b>QS</b>
			W1	L1	<b>15-A344-W1-L1</b> <b>QS</b>
			60	EZ	<b>15-A344-60-EZ</b> <b>QS</b>
DALI-2 / PUSH 220-240V	2700	2341	FB	FA	<b>15-A345-FB-FA</b>
			W1	L1	<b>15-A345-W1-L1</b>
			60	EZ	<b>15-A345-60-EZ</b>
PHASE CUT 220-240V	3000	2394	FB	FA	<b>15-A346-FB-FA</b> <b>QS</b>
			W1	L1	<b>15-A346-W1-L1</b> <b>QS</b>
			60	EZ	<b>15-A346-60-EZ</b> <b>QS</b>
DALI-2 / PUSH 220-240V	3000	2394	FB	FA	<b>15-A347-FB-FA</b>
			W1	L1	<b>15-A347-W1-L1</b>
			60	EZ	<b>15-A347-60-EZ</b>
PHASE CUT 220-240V	4000	2454	FB	FA	<b>15-A348-FB-FA</b> <b>QS</b>
			W1	L1	<b>15-A348-W1-L1</b> <b>QS</b>
			60	EZ	<b>15-A348-60-EZ</b> <b>QS</b>
DALI-2 / PUSH 220-240V	4000	2454	FB	FA	<b>15-A349-FB-FA</b>
			W1	L1	<b>15-A349-W1-L1</b>
			60	EZ	<b>15-A349-60-EZ</b>

Los acabados y tonalidad mostrados pueden no ser completamente precisos debido a ligeras variaciones en la producción, factores de iluminación fotográficas e impresión.

Os acabamentos e tonalidades apresentados podem não ser totalmente precisos, devido a ligeiras variações na produção, fatores de iluminação fotográfica e de impressão.

Gris Seda Cinzento Seda	FB
Tejido Crema Tecido Creme	FA
Marrón Caoba Castanho Caoba	W1
Terracota jaspeado Terracota jaspeado	L1
Negro Preto	60
Tejido Negro Tecido Preto	EZ

# Spark



## Performance Universe



P. 278



### Inspiración nórdica

De inspiración nórdica, la sencillez de los elementos encuentra su razón de ser en la perfección de las formas y en sus combinaciones. Con distintas posibilidades de composición Spark propone un juego de volúmenes que se combinan alrededor de un perfil que pasa prácticamente desapercibido. Diseñada sin ataduras, sus posibilidades de instalación responden a su misma esencia de libertad.

### Inspiração nórdica

De inspiração nórdica, a simplicidade dos elementos encontra a sua razão de ser na perfeição das formas e nas suas combinações. Com diferentes possibilidades de composição Spark propõe um jogo de volumes que se combinam em torno de um perfil que passa praticamente despercebido. Concebida sem laços, as suas possibilidades de instalação respondem à sua própria essência de liberdade.





Los tres cuerpos lumínicos generan tres volúmenes diferenciados.  
Os três corpos luminicos geram três volumes diferenciados.

### Spark Single Ø140mm

BODY MAT	DIF MAT		SWITCH CCT
ST	GLA		2700-3000-4000

Negro Preto 05 ●  
Arenado Areado F9 ○

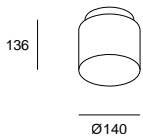

LED | K 2700-3000-4000 | CRI 92 | W Total 10 | Real Lm 424 (3000K)

	Structure	Difussor	Code
	PHASE CUT 220-240V	05 ● F9 ○	15-A125-05-F9

### Spark Single Ø240mm

BODY MAT	DIF MAT		SWITCH CCT
ST	GLA		2700-3000-4000

Negro Preto 05 ●  
Arenado Areado F9 ○

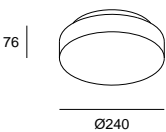

LED | K 2700-3000-4000 | CRI 92 | W Total 16 | Real Lm 652 (3000K)

	Structure	Difussor	Code
	PHASE CUT 220-240V	05 ● F9 ○	15-A126-05-F9

### Spark Single Ø390mm

BODY MAT	DIF MAT		SWITCH CCT
ST	GLA		2700-3000-4000

Negro Preto 05 ●  
Arenado Areado F9 ○

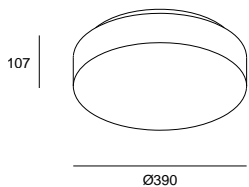

LED | K 2700-3000-4000 | CRI 92 | W Total 43.7 | Real Lm 2083 (3000K)

	Structure	Difussor	Code
	DALI 220-240V	05 ● F9 ○	15-A127-05-F9



Desarrollado de forma minuciosa para conseguir un vidrio de calidad y un perfil muy fino con las mejores prestaciones técnicas.

Desenvolvido de forma minuciosa para conseguir um vidro de qualidade e um perfil muito fino com as melhores prestações técnicas.

### Spark Double Ø390mm + Ø140mm

BODY MAT	DIF MAT		SWITCH CCT
ST	GLA		2700-3000-4000

Negro Preto 05 ●  
Arenado Areado F9 ○

LED | K 2700-3000-4000 | CRI 92 | W Total 53.5 | Real Lm 2507 (3000K)

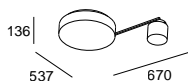

DALI 220-240V

Structure

05 ●

Difussor

F9 ○

Code

15-A128-05-F9

### Spark Double Ø390mm + Ø240mm

BODY MAT	DIF MAT		SWITCH CCT
ST	GLA		2700-3000-4000

Negro Preto 05 ●  
Arenado Areado F9 ○

LED | K 2700-3000-4000 | CRI 92 | W Total 60.5 | Real Lm 2735 (3000K)

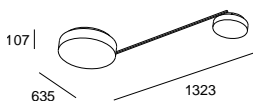

DALI 220-240V

Structure

05 ●

Difussor

F9 ○

Code

15-A129-05-F9

### Spark Triplex Ø390mm + Ø240mm + Ø140mm

BODY MAT	DIF MAT		SWITCH CCT
ST	GLA		2700-3000-4000

Negro Preto 05 ●  
Arenado Areado F9 ○

LED | K 2700-3000-4000 | CRI 92 | W Total 68.5 | Real Lm 3159 (3000K)

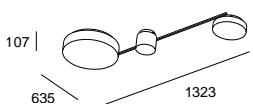

DALI 220-240V

Structure

05 ●

Difussor

F9 ○

Code

15-A130-05-F9

# Caprice



Performance Universe



P. 168



## Eficiencia lumínica

Caprice ofrece diversidad de funciones avanzadas en un producto decorativo que se adapta a ambientes con grandes exigencias lumínicas.

## Eficiência lumínica

Caprice oferece diversidade de funções avançadas num produto decorativo que se adapta a ambientes com grandes exigências lumínicas.



2700K



3000K



4000K

Cuenta con un switch integrado.  
Possui um switch integrado.

### Caprice ø240mm

QS

BODY MAT	DIF MAT		SWITCH CCT
ST	ACR		2700-3000-4000

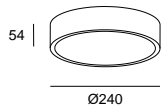

LED | K 2700-3000-4000 | CRI 92 | W Total 14.1 | Real Lm 896 (3000K)

Blanco Branco 14   
Negro Preto 60   
Blanco opal Branco opalino M1

	Body	Difusor	Code
PHASE CUT 220-240V	14 <input type="radio"/> 60 <input checked="" type="radio"/>	M1 <input type="radio"/> M1 <input type="radio"/>	<b>15-6196-14-M1</b> <b>15-6196-60-M1</b>

Acabados The Colours bajo pedido mínimo de 15 unidades. Consultar precios en tarifa y plazos de entrega con equipo comercial.  
Acabamentos The Colours sujeitos a encomenda mínima de 15 unidades. Consultar preços e prazos de entrega com a nossa equipa comercial.

Body:  DL Oro Ouro Difusor:  M1 Blanco opal Branco opalino

### Caprice ø330mm

QS

BODY MAT	DIF MAT		SWITCH CCT
ST	ACR		2700-3000-4000

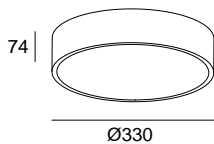

LED | K 2700-3000-4000 | CRI 92 | W Total 20 | Real Lm 1258 (3000K)

Blanco Branco 14   
Negro Preto 60   
Blanco opal Branco opalino M1

	Body	Difusor	Code
PHASE CUT 220-240V	14 <input type="radio"/> 60 <input checked="" type="radio"/>	M1 <input type="radio"/> M1 <input type="radio"/>	<b>15-6197-14-M1</b> <b>15-6197-60-M1</b>

Acabados The Colours bajo pedido mínimo de 15 unidades. Consultar precios en tarifa y plazos de entrega con equipo comercial.  
Acabamentos The Colours sujeitos a encomenda mínima de 15 unidades. Consultar preços e prazos de entrega com a nossa equipa comercial.

Body:  DL Oro Ouro Difusor:  M1 Blanco opal Branco opalino

### Caprice ø520mm

QS

BODY MAT	DIF MAT		SWITCH CCT
ST	ACR		2700-3000-4000

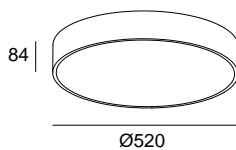

LED | K 2700-3000-4000 | CRI 92 | W Total 39.6 | Real Lm 3072 (3000K)

Blanco Branco 14   
Negro Preto 60   
Blanco opal Branco opalino M1

	Body	Difusor	Code
PHASE CUT 220-240V	14 <input type="radio"/> 60 <input checked="" type="radio"/>	M1 <input type="radio"/> M1 <input type="radio"/>	<b>15-6433-14-M1</b> <b>15-6433-60-M1</b>

Acabados The Colours bajo pedido mínimo de 15 unidades. Consultar precios en tarifa y plazos de entrega con equipo comercial.  
Acabamentos The Colours sujeitos a encomenda mínima de 15 unidades. Consultar preços e prazos de entrega com a nossa equipa comercial.

Body:  DL Oro Ouro Difusor:  M1 Blanco opal Branco opalino

# MISO



## Essential Universe



P. 309



### Una opción esencial con distintas combinaciones

De líneas suaves y discretas, Miso es un plafón esencial que se adapta a todos los espacios. Con dos medidas disponibles, ofrece una enorme flexibilidad de acabados gracias a la combinación de acabados de su estructura interior y exterior.

### Uma opção essencial com diferentes combinações

Com linhas suaves e discretas, Miso é um plafon essencial que se adapta a todos os espaços. Com dois tamanhos disponíveis, oferece uma enorme flexibilidade de acabamentos graças à combinação de acabamentos da sua estrutura interior e exterior.



15-8330-05-14



15-8330-05-DL



15-8330-14-DL



7 combinaciones de color posibles en 2 tamaños distintos.

7 combinações de cor possíveis em 2 tamanhos diferentes.

### Miso 285mm

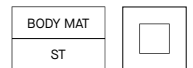

Blanco Branco 14 ○  
Negro Preto 05 ●  
Oro Ouro DL ○

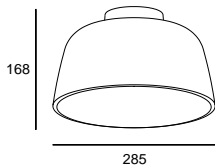

E27 | W Max. 15

Exterior Screen Interior Screen

Code

05 ●	14 ○
05 ●	DL ○
14 ○	14 ○
14 ○	DL ○

<b>15-8330-05-14</b>	
<b>15-8330-05-DL</b>	QS
<b>15-8330-14-14</b>	QS
<b>15-8330-14-DL</b>	

\*Bombilla no incluida.  
\*Lâmpada não incluida.

Acabados The Colours bajo pedido mínimo de 15 unidades. Consultar precios en tarifa y plazos de entrega con equipo comercial.  
Acabamentos The Colours sujeitos a encomenda mínima de 15 unidades. Consultar preços e prazos de entrega com a nossa equipa comercial.

Exterior Screen: ○ DL Oro Ouro Interior Screen: ○ 14 Blanco Branco

### Miso 433mm

QS

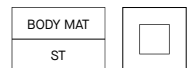

Blanco Branco 14 ○  
Negro Preto 05 ●  
Oro Ouro DL ○  
Gris piedra Cinzento pedra EM ○

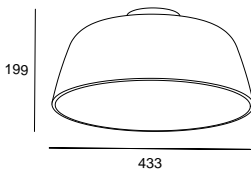

E27 | W Max. 15

Exterior Screen Interior Screen

Code

05 ●	DL ○
14 ○	14 ○
14 ○	DL ○

<b>15-8331-05-DL</b>
<b>15-8331-14-14</b>
<b>15-8331-14-DL</b>

\*Bombilla no incluida.  
\*Lâmpada não incluida.

Acabados The Colours bajo pedido mínimo de 15 unidades. Consultar precios en tarifa y plazos de entrega con equipo comercial.  
Acabamentos The Colours sujeitos a encomenda mínima de 15 unidades. Consultar preços e prazos de entrega com a nossa equipa comercial.

Exterior Screen: ○ DL Oro Ouro Interior Screen: ○ 14 Blanco Branco

# Bol



## Performance Universe



P. 177



### Bol Ø450mm

QS

BODY MAT  
ST

DIF MAT  
ACR,TEX

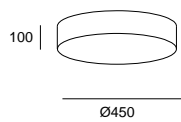

LED | K 3000 | CRI 80 | W Total 23 | Real Lm 1064

Arena Areia BY   
Blanco opal Branco opalino M1



Body

Difussor

Code

ON-OFF 100-240V

BY

M1

15-4922-BY-M1

### Bol Ø700mm

QS

BODY MAT  
ST

DIF MAT  
ACR,TEX

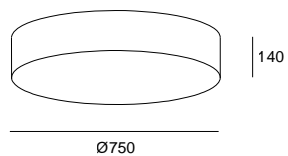

LED | K 3000 | CRI 80 | W Total 33 | Real Lm 1646

Arena Areia BY



Body

Code

ON-OFF 220-240V

BY

15-A052-BY-M1

# Vetro



## Performance Universe



P. 311



P. 370



Un clásico con un vidrio prensado de doble grosor especial.

Um clássico com um vidro prensado de dupla espessura especial.



## Vetro

QS

BODY MAT	DIF MAT		IP
ST	GLA		44

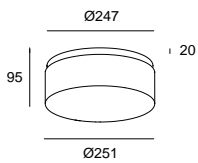

LED | K 3000 | CRI 80 | W Total 22.4 | Real Lm 1240

Blanco Branco 14   
Cristal pintado blanco interior G5   
Vidro pintado branco interior

	Body	Difussor	Code
ON-OFF 220-240V	14 <input type="radio"/>	G5 <input checked="" type="radio"/>	05-7387-14-G5

# Prolix



## Performance Universe



P. 154



P. 294



### Estilo y elegancia

Prolix plafón se adapta a los ambientes no sólo por la elegancia de su silueta facetada y la pureza de sus acabados dorado y negro mate, sino también por la adaptabilidad del efecto de luz gracias a la rotación de su estructura y sus ejes focales. Además, la óptica puede regularse de forma manual con un zoom ajustable de 15° a 50°.

### Estilo e elegância

O plafon Prolix adapta-se a qualquer ambiente não só pela elegância da sua silhueta facetada e pela pureza dos seus acabamentos dourado e preto mate, mas também pela adaptabilidade do efeito de luz graças à rotação da sua estrutura e aos seus eixos focais. Além disso, a ótica pode ser regulada de forma manual com um zoom ajustável de 15° a 50°.



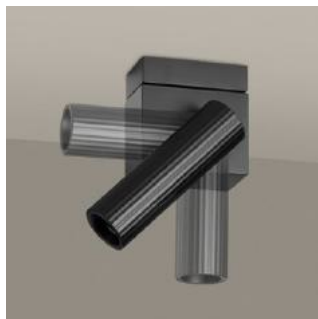

Óptica regulable para aumentar el ángulo de luz (Zoom 15°-50°).

Ótica regulável para aumentar o ângulo da luz (Zoom 15°-50°).

## Prolix Double

QS

BODY MAT	DIF MAT			
AL	PMMA		180°	90°

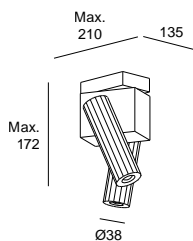

LED | K 2700 | CRI 92 | W Total 20 | Real Lm 639

Negro Preto 05 ●  
Oro mate Ouro mate DN ●



PHASE CUT 220-240V

Structure Code

05 ● **15-8514-05-05**  
DN ● **15-8514-DN-DN**

# Simply



## Essential Universe



P. 197



P. 230



### Simply 1 body

QS

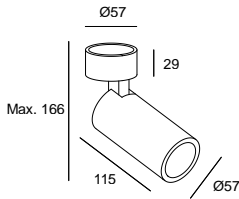

GU10 | W Max. 8

Blanco Branco 14   
Negro Preto 05

#### Structure

#### Code

05   
14

15-7982-05-05  
15-7982-14-14

\*Bombilla no incluida.  
\*Lâmpada não incluída.

### Simply 2 bodies

QS

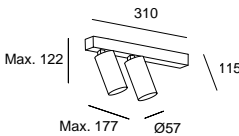

GU10 | W 2 × Max. 8

Blanco Branco 14   
Negro Preto 05

#### Structure

#### Code

05   
14

05-8335-05-05  
05-8335-14-14

\*Bombilla no incluida.  
\*Lâmpada não incluída.

### Simply 3 bodies

QS

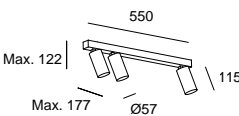

GU10 | W 3 × Max. 8

Blanco Branco 14   
Negro Preto 05

#### Structure

#### Code

05   
14

05-8336-05-05  
05-8336-14-14

\*Bombilla no incluida.  
\*Lâmpada não incluída.

Incluido  
Incluido

Panel de abeja  
Favo de abelha

# Pipe



## Essential Universe



P. 170



P. 196

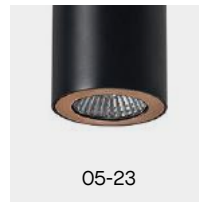

05-23



14-05

Combinaciones standard.  
Combinações padrão.



14-14



05-05

Posibilidad de otras combinaciones mediante aros no incluidos.  
Possibilidade de outras combinações por aros não incluídos.

## Pipe Single

QS

BODY MAT  
ST,AL



Blanco Branco 14 ○  
Negro Preto 05 ●  
Oro Ouro 23 ●

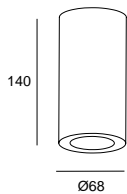

GU10 | W Max. 8

**Body**                      **Ring**

05 ●                      23 ●  
14 ○                      05 ●

**Code**

**15-0073-05-23**  
**15-0073-14-05**

\*Bombilla no incluida.  
\*Lâmpada não incluída.

**Acc. comunes no incluídos**  
**Ac. comuns não incluídos**

Aro blanco  
Aro branco  
Aro negro  
Aro preto

**71-0073-14-14**

**71-0073-05-05**

# Stylus



## Essential Universe



P. 172



P. 198



## Stylus

BODY MAT	DIF MAT			
AL	PC			

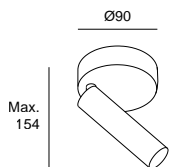

LED | K 3000 | CRI 92 | W Total 6.4 | Real Lm 364

Blanco Branco 14 ○  
Negro Preto 05 ●

	Finishing	Code
	05 ●	<b>05-5478-05-05</b>
	14 ○	<b>05-5478-14-14</b>

ON-OFF 100-240V

# Baño

## Casa de banho



Perlina

358



Bloom

360



Dresde LED

362



Toi LED

364



Toilet Slim

366



Mist

368

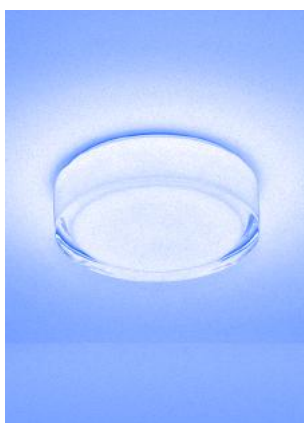

Vetro

370

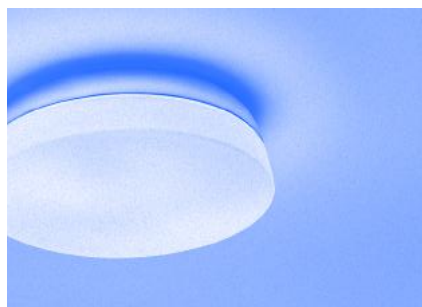

Dec

371



Vanity

372

# Perlina



## Performance Universe



P. 182



P. 220



P. 254



P. 276



### Joya natural

Perlina se inspira en una joya natural para ofrecer una perla iluminada que juega con la esencia de la circunferencia, redonda y perfecta, dando sentido al minimalismo de lo básico. La opción con IP44, proporciona un efecto de luz tamizada a través de la esfera que transmite un sentimiento de calma llenando el espacio con naturalidad.

### Joia natural

Perlina inspira-se numa joia natural para oferecer uma pérola iluminada que brinca com a essência da circunferência, redonda e perfeita, dando sentido ao minimalismo do básico. A opção com IP44 proporciona um efeito de luz filtrada através da esfera que transmite uma sensação de calma, enchendo o espaço de naturalidade.



**Perlina IP44**

**QS**

BODY MAT	DIF MAT		IP	SWITCH CCT
AISI304	GLA		44	2700-3000-4000

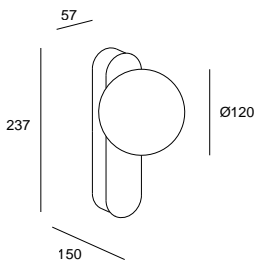

**LED | K 2700-3000-4000 | CRI 92 | W Total 8.8 | Real Lm 391 (3000K)**

Negro Preto 60 ●  
Oro mate Ouro mate DN ●



ON-OFF 220-240V

DALI-2 220-240V

**Structure Code**

60 ●	<b>05-A076-60-60</b>
DN ●	<b>05-A076-DN-DN</b>
60 ●	<b>05-A077-60-60</b>
DN ●	<b>05-A077-DN-DN</b>

**QS** Quick Service | 2-6 días laborables (tiempo de transporte no incluido)  
Quick Service | 2-6 dias úteis (tempo de transporte não incluído)

# Bloom



Essential Universe



P. 288



## Diseño amable y sencillez de las formas

La sencillez y la funcionalidad son a menudo la mejor carta de presentación. Bloom tiene un diseño amable, equilibrado en las formas, que la hacen destacar en el espacio precisamente por la suavidad de su perfil. Su desarrollo técnico, con un IP44, la convierten en una opción apta para la iluminación de baños.

## Design amigável e simplicidade de formas

A simplicidade e a funcionalidade são muitas vezes a melhor carta de apresentação. Bloom tem um design amigável, equilibrado nas formas, o que a fazem sobressair no espaço precisamente devido à suavidade do seu perfil. O seu desenvolvimento técnico, com um IP44, torna-a uma opção adequada para a iluminação de casas de banho.



## Bloom

QS

BODY MAT	DIF MAT		IP
ST	GLA		44

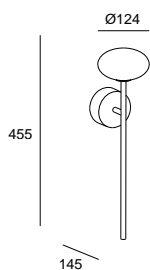

LED | K 2700 | CRI 92 | W Total 7.5 | Real Lm 262

Negro Preto 05 ●  
 Blanco opal Blanco opalino M1 ○

	Structure	Difussor	Code
ON-OFF 100-227V	05 ●	M1 ○	05-A011-05-M1

**QS** Quick Service | 2-6 días laborables (tiempo de transporte no incluido)  
 Quick Service | 2-6 dias úteis (tempo de transporte não incluído)

# Dresde LED



Performance Universe





Acabados en negro y níquel.  
Acabamentos a preto e níquel.

## Dresde LED

QS

BODY MAT	DIF MAT		IP
AL	GLA		44

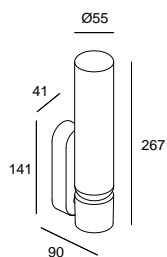

LED | K 3000 | CRI 92 | W Total 9.5 | Real Lm 563

Negro Preto 05 ●  
Cromo Cromado 21 ●  
Arenado Areado F9 ○

	Structure	Difussor	Code
ON-OFF 220-240V	05 ● 21 ●	F9 ○ F9 ○	<b>05-A012-05-F9</b> <b>05-A012-21-F9</b>

QS Quick Service | 2-6 días laborables (tiempo de transporte no incluido)  
Quick Service | 2-6 dias úteis (tempo de transporte não incluído)

# Toi LED



Performance Universe





### Toi LED Small

QS

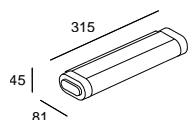

BODY MAT	DIF MAT	IP
AL	PC	44

Cromo Cromado 21   
Blanco opal Branco opalino M1

LED | K 3000 | CRI 80 | W Total 8.7 | Real Lm 727



ON-OFF 220-240V

Structure

21

Difussor

M1

Code

05-7831-60-M1

### Toi LED Medium

QS

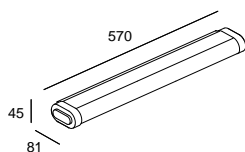

BODY MAT	DIF MAT	IP
AL	PC	44

Negro Preto 60   
Cromo Cromado 21   
Blanco opal Branco opalino M1

LED | K 3000 | CRI 80 | W Total 15.3 | Real Lm 1513



ON-OFF 220-240V

Structure

21   
60

Difussor

M1   
M1

Code

05-7833-21-M1  
 05-7833-60-M1

# Toilet Slim



Performance Universe



**Toilet Slim 332mm****QS**

BODY MAT	DIF MAT		IP
AL	PC		44

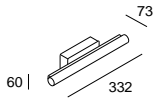
**LED | K 3000 | CRI 92 | W Total 13.2 | Real Lm 880**

Cromo Cromado 21

Blanco opal Branco opalino M1

	Structure	Difusor	Code
ON-OFF 220-240V	21 <input checked="" type="radio"/>	M1 <input type="radio"/>	<b>05-A005-21-M1</b>

**Toilet Slim 632mm****QS**

BODY MAT	DIF MAT		IP
AL	PC		44

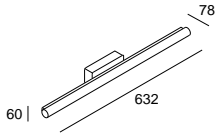
**LED | K 3000 | CRI 92 | W Total 25 | Real Lm 1777**

Cromo Cromado 21

Blanco opal Branco opalino M1

	Structure	Difusor	Code
ON-OFF 100-240V	21 <input checked="" type="radio"/>	M1 <input type="radio"/>	<b>05-6396-21-M1</b>

**Toilet Slim 932mm****NEW****QS**

BODY MAT	DIF MAT		IP
AL	PC		44

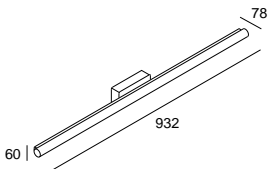
**LED | K 3000 | CRI 92 | W Total 32.7 | Real Lm 2431**

Cromo Cromado 21

Blanco opal Branco opalino M1

	Structure	Difusor	Code
ON-OFF 220-240V	21 <input checked="" type="radio"/>	M1 <input type="radio"/>	<b>05-A102-21-M1</b>

# Mist



Essential Universe



P. 164



## Sencillez y acierto

La sencillez de un diseño neutro que destaca la importancia de la bombilla. Mist es una colección de baño con distintas posibilidades de instalación que, gracias a esta característica y las opciones de acabados, ofrece una valorada riqueza compositiva.

## Simplicidade e eficácia

A simplicidade de um design neutro que realça a importância da lâmpada. Mist é uma coleção de casa de banho com diferentes possibilidades de instalação que, graças a esta característica e às opções de acabamentos, oferece uma valiosa riqueza composicional.



## Mist 1 body

QS

BODY MAT	DIF MAT		IP
ST	GLA		44

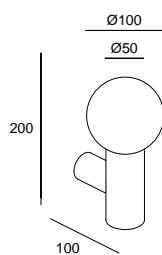

E14 Max. L 97 mm - Ø 35 mm | W Max. 9

Negro Preto 05 ●  
 Cromo Cromado 21 ●  
 Arenado Areado F9 ○

Structure Difussor

Code

05 ● F9 ○  
 21 ● F9 ○

05-8337-05-F9  
 05-8337-21-F9

## Mist Pendant

QS

BODY MAT	DIF MAT		IP
ST	GLA		44

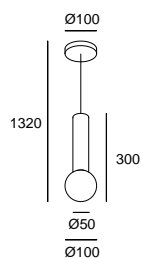

E14 Max. L 97 mm - Ø 35 mm | W Max. 9

Negro Preto 05 ●  
 Cromo Cromado 21 ●  
 Arenado Areado F9 ○

Structure Difussor

Code

05 ● F9 ○  
 21 ● F9 ○

00-8337-05-F9  
 00-8337-21-F9

# Vetro



## Performance Universe



P. 311



P. 349



Un clásico con un vidrio prensado de doble grosor especial.

Um clássico com um vidro prensado de dupla espessura especial.

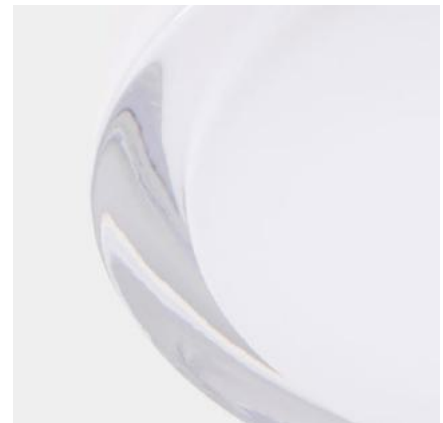

### Vetro

QS

BODY MAT	DIF MAT		IP
ST	GLA		44

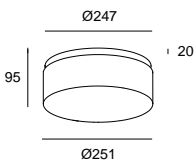

LED | K 3000 | CRI 80 | W Total 22.4 | Real Lm 1240

Blanco Branco 14   
 Cristal pintado blanco interior G5   
 Vidro pintado branco interior



ON-OFF 220-240V

Structure

14

Difussor

G5

Code

05-7387-14-G5

# Dec



Essential Universe



Dec

QS

BODY MAT	DIF MAT		IP
ST	GLA		44

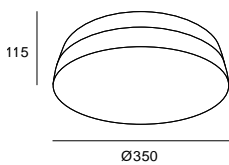

E27 | W 2 × Max. 15

Cromo Cromado 21

Arenado Areado F9

**Structure**      **Difussor**

21       F9

**Code**

**15-4370-21-F9**

\*Bombilla no incluida.  
\*Lâmpada não incluída.

# Vanity



Performance Universe



## Diseño contemporáneo

Espejo de baño con un diseño especial contemporáneo y muy atractivo.

## Design contemporâneo

Espelho de casa de banho com um design especial contemporâneo e muito atrativo.



Vanity ofrece un gran confort gracias a su suave rotación y su regulación dimable.

Vanity oferece um grande conforto graças à sua rotação suave e à sua regulação dimmable.

## Vanity

QS

BODY MAT	DIF MAT		IP				
AL	MIR		44	150°	180°	x3	DIM

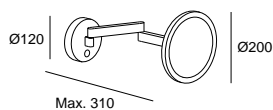

LED | K 3000 | CRI 92 | W Total 10.5 | Real Lm 256



TOUCH DIMMING 100-240V

Structure

05 ●  
21 ○

Body

K3 ○  
K3 ○

Code

**75-8508-05-K3**

**75-8508-21-K3**

Negro Preto 05 ●  
Cromo Cromado 21 ○  
Cristal espejo Vidro espelho K3 ○

# Fans

**Ventilación**  
**Forlight by LedsC4**

**Ventilação**  
**Forlight by LedsC4**









# Ventilación

## Ventilação

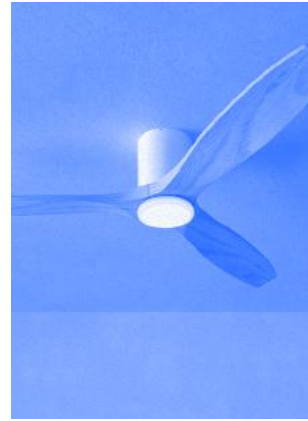

Stem Evo

382



Marinada

394



Bosc

396

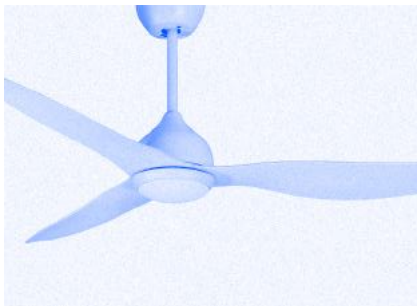

Pam

398



Bora

402

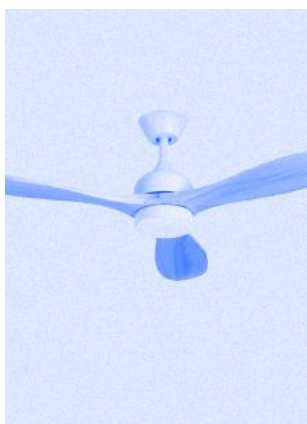

**Calar**

**404**



**Helix**

**400**

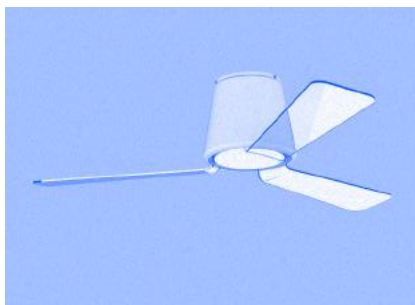

**Garbi**

**406**

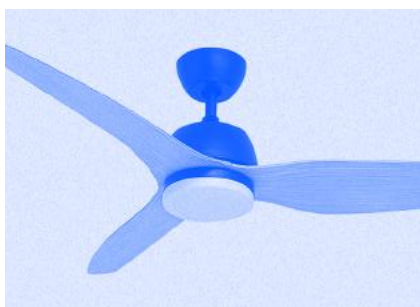

**July**

**408**



**Shadow**

**410**

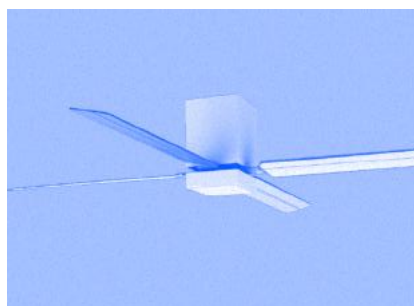

**Zonda**

**412**

# Stem Evo NEW

Performance Collection



## Diseño pensado para el bienestar

La silueta orgánica y los acabados nobles de Stem Evo envuelven el aire con suavidad, integrándose de forma natural en interiores que priorizan la calma y el diseño. Su presencia es sutil pero intencionada: acompaña sin imponerse, refresca en silencio y aporta una belleza serena que transforma cada espacio.

Gracias a sus múltiples combinaciones, Stem Evo se adapta a cada ambiente manteniendo intacta su esencia: equilibrio, funcionalidad y una elegancia atemporal pensada para perdurar.

## Design pensado para o bem-estar

A silhueta orgânica e os acabamentos nobres de Stem Evo envolvem o ar com suavidade, integrando-se de forma natural em interiores que privilegiam a calma e o design. A sua presença é subtil, mas intencional: acompanha sem se impor, refresca em silêncio e proporciona uma beleza serena que transforma cada espaço.

Graças às suas múltiplas combinações, Stem Evo adapta-se a cada ambiente, mantendo intacta a sua essência: equilíbrio, funcionalidade e uma elegância intemporal pensada para durar.



# Configura tu Stem Evo

## Configure a sua Stem Evo

Configuración personalizable, pensada para integrarse con elegancia y originalidad a cualquier proyecto.  
 Configuração personalizável, concebida para se integrar com elegância e originalidade em qualquer projeto.

### 1 Tamaño

#### Tamanho



Ø 1220



Ø 1320

### 2 Estructura

#### Estrutura



Pendant



Tube

### 3 Acabado de la estructura

#### Acabamento da estrutura



**B**  
Blanco  
Branco

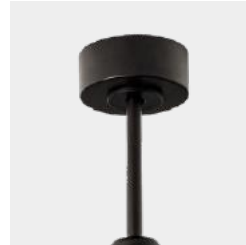

**N**  
Negro  
Preto



**S**  
Níquel satinado  
Níquel escovado

### 4 Acabado de las palas

#### Acabamento das pás



**BL**  
Blanco  
Branco



**FC**  
Madera natural  
Madeira natural



**NE**  
Negro  
Preto



**FF**  
Nogal oscuro  
Nogueira escura

### 5 Iluminación

#### Iluminação



Sin luz  
Sem luz



Con luz LED  
Com luz LED



Kit Play Super Comfort

Ventilación e iluminación de altas prestaciones con el kit de luz Play, diseñadas para garantizar confort visual, eficiencia y bienestar.

Ventilação e iluminação de elevado desempenho com o kit de luz Play, concebidas para garantir o conforto visual, a eficácia e o bem-estar.



# Stem Evo without light



### Structure

- Blanco Branco
- Negro Preto
- Níquel satinado  Níquel acetinado

### Blades

- Blanco Branco BL
- Madera natural Madeira natural FC
- Negro Preto NE
- Nogal oscuro Nogueira escura FF

## Stem Evo

QS

BODY MAT	BLADES MAT	↑	⊥	DC	AIRFLOW	☀	🌊	🔊	📶	💡
AISI316	SOLID WOOD	20-32m <sup>2</sup>		MOTOR	M 137 m <sup>3</sup> /min L 164 m <sup>3</sup> /min					

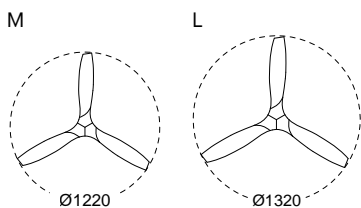
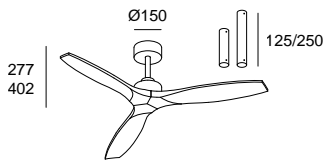

W	Source	Side	Code	Structure	Blades		
30	100-240V	Ø 1220	VE-0114	B <input type="radio"/> - N <input checked="" type="radio"/> S <input type="radio"/>	BL <input type="radio"/> FC <input type="radio"/> NE <input checked="" type="radio"/> FF <input type="radio"/>		
30	100-240V	Ø 1320	VE-0096	B <input type="radio"/> - N <input checked="" type="radio"/> S <input type="radio"/>	BL <input type="radio"/> FC <input type="radio"/> NE <input checked="" type="radio"/> FF <input type="radio"/>		
<b>Speed</b>							
RPM		1	2	3	4	5	6
		82	106	123	148		190



**Structure**

- Blanco Branco
- Negro Preto
- Níquel satinado Níquel acetinado

**Blades**

- Blanco Branco BL
- Madera natural Madeira natural FC
- Negro Preto NE
- Nogal oscuro Nogueira escura FF

**Stem Evo Tube**

**QS**

BODY MAT AISI316	BLADES MAT SOLID WOOD	20-32m <sup>2</sup>		DC MOTOR	AIRFLOW M 137 m <sup>3</sup> /min L 164 m <sup>3</sup> /min				
---------------------	--------------------------	---------------------	--	-------------	---	--	--	--	--

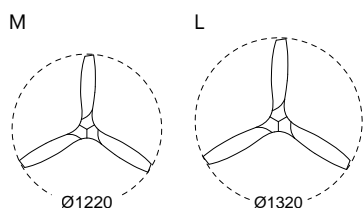
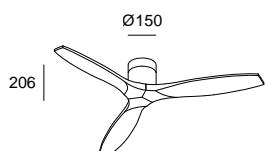

W	Source	Side	Code	Structure	Blades		
30	100-240V	Ø 1220	<b>VE-0115</b>	B <input type="radio"/> - N <input type="radio"/> S <input type="radio"/>	BL <input type="radio"/> FC <input type="radio"/> NE <input type="radio"/> FF <input type="radio"/>		
30	100-240V	Ø 1320	<b>VE-0098</b>	B <input type="radio"/> - N <input type="radio"/> S <input type="radio"/>	BL <input type="radio"/> FC <input type="radio"/> NE <input type="radio"/> FF <input type="radio"/>		
<b>Speed</b>		<b>1</b>	<b>2</b>	<b>3</b>	<b>4</b>	<b>5</b>	<b>6</b>
RPM		82	106	123	148		190

**QS** Quick Service | 2-6 días laborables (tiempo de transporte no incluido)  
Quick Service | 2-6 dias úteis (tempo de transporte não incluído)

# Stem Evo with light



### Structure

- Blanco Branco
- Negro Preto
- Níquel satinado  Níquel acetinado

### Blades

- Blanco Branco BL
- Madera natural Madeira natural FC
- Negro Preto NE
- Nogal oscuro Nogueira escura FF

## Stem Evo

QS

BODY MAT	DIF MAT	BLADES MAT	M 13-20 L 20-32	DC MOTOR	AIRFLOW M 137 m³/min L 164 m³/min	SUN	WAVE	SPEAKER	WIFI	SWITCH CCT 3000/4000/5000K	DIM
AISI316	GLASS	SOLID WOOD									

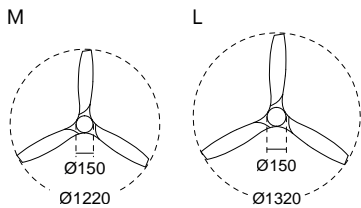
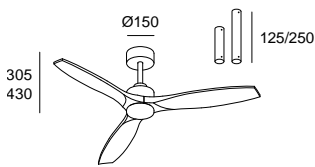

### LED

W	CRI	K	Real Lm	Source	Side	Code	Structure	Blades
50	50	3000	2875	100-240VAC	Ø 1220	VE-0112	B <input type="radio"/>	BL <input type="radio"/>
		4000					N <input type="radio"/>	FC <input type="radio"/>
		5000					S <input type="radio"/>	NE <input type="radio"/>
50	50	3000	2875	100-240VAC	Ø 1320	VE-0095	B <input type="radio"/>	BL <input type="radio"/>
		4000					N <input type="radio"/>	FC <input type="radio"/>
		5000					S <input type="radio"/>	NE <input type="radio"/>
								FF <input type="radio"/>

El flujo indicado por cada óptica corresponde al de 4000K de Temperatura de color.  
The luminous flux indicated for each optic corresponds to that of a 4000K color temperature.

Speed	1	2	3	4	5	6
RPM	82	106	123	148		190

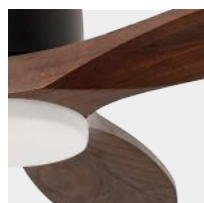

**Structure**

- Blanco Branco
- Negro Preto
- Níquel satinado Níquel acetinado

**Blades**

- Blanco Branco BL
- Madera natural Madeira natural FC
- Negro Preto NE
- Nogal oscuro Nogueira escura FF

**Stem Evo Tube**

QS

BODY MAT AISI316	DIF MAT GLASS	BLADES MAT SOLID WOOD	M 13-20 L 20-32		DC MOTOR	AIRFLOW M 137 m³/min L 164 m³/min				SWITCH CCT 3000/4000/5000K		DIM
---------------------	------------------	--------------------------	--------------------	--	-------------	---	--	--	--	-------------------------------	--	-----

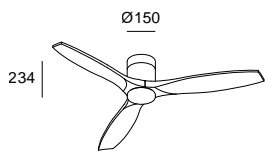

M

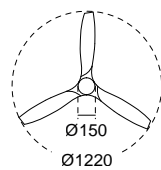

L

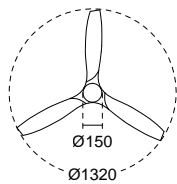

**LED**

W	CRI	K	Real Lm	Source	Side	Code	Structure	Blades
50	4000	3000	2875	100-240VAC	Ø 1220	VE-0113	B <input type="radio"/>	BL <input type="radio"/>
		4000					- N <input type="radio"/>	FC <input type="radio"/>
		5000					S <input type="radio"/>	NE <input type="radio"/>

50	4000	3000	2875	100-240VAC	Ø 1320	VE-0097	B <input type="radio"/>	BL <input type="radio"/>
		4000					- N <input type="radio"/>	FC <input type="radio"/>
		5000					S <input type="radio"/>	NE <input type="radio"/>

El flujo indicado por cada óptica corresponde al de 4000K de Temperatura de color.  
The luminous flux indicated for each optic corresponds to that of a 4000K color temperature.

Speed	1	2	3	4	5	6
RPM	82	106	123	148		190

# Stem Evo with Play Super Comfort



### Structure

- Blanco Branco
- Negro Preto
- Níquel satinado  Níquel acetinado

### Blades

- Blanco Branco BL
- Madeira natural Madeira natural FC
- Negro Preto NE
- Nogal oscuro Nogueira escura FF

## Stem Evo

QS

BODY MAT	DIF MAT	BLADES MAT				AIRFLOW				
AISI316	GLASS	SOLID WOOD	13-20m <sup>2</sup>	20-32m <sup>2</sup>	MOTOR	L 164 m <sup>3</sup> /min M 137 m <sup>3</sup> /min				

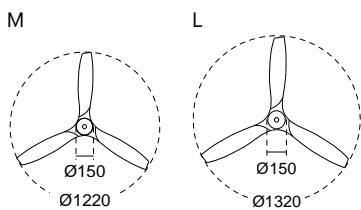
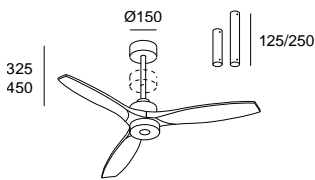

### LED

W	CRI	K	Real Lm	Optics	Source	Side	Code	Structure	Blades
42.1	2700	1350			100-240VAC	Ø1220	<b>VE-0120</b>	B <input type="radio"/> N <input type="radio"/> S <input type="radio"/>	BL <input type="radio"/> FC <input type="radio"/> NE <input type="radio"/> FF <input type="radio"/>
42.1	2700	1350			100-240VAC	Ø1320	<b>VE-0118</b>	B <input type="radio"/> N <input type="radio"/> S <input type="radio"/>	BL <input type="radio"/> FC <input type="radio"/> NE <input type="radio"/> FF <input type="radio"/>
<b>Speed</b>									
RPM	1	2	3	4	5	6			
	82	106	123	148		190			



**Structure**

- Blanco Branco
- Negro Preto
- Níquel satinado Níquel acetinado

**Blades**

- Blanco Branco BL
- Madera natural Madeira natural FC
- Negro Preto NE
- Nogal oscuro Nogueira escura FF

**Stem Evo Tube**

QS

BODY MAT AISI316	DIF MAT GLASS	BLADES MAT SOLID WOOD	13-20m²	20-32m²		DC MOTOR	AIRFLOW L 164 m³/min M 137 m³/min			
---------------------	------------------	--------------------------	---------	---------	--	-------------	---	--	--	--

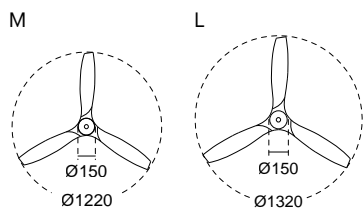
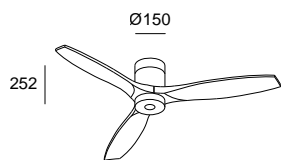

**LED**

W	CRI	K	Real Lm	Optics	Source	Side	Code	Structure	Blades
42.1	2700	1350			100-240VAC	Ø 1220	<b>VE-0121</b>	B <input type="radio"/> N <input type="radio"/> S <input type="radio"/>	BL <input type="radio"/> FC <input type="radio"/> NE <input type="radio"/> FF <input type="radio"/>
42.1	2700	1350			100-240VAC	Ø 1320	<b>VE-0119</b>	B <input type="radio"/> N <input type="radio"/> S <input type="radio"/>	BL <input type="radio"/> FC <input type="radio"/> NE <input type="radio"/> FF <input type="radio"/>

**Speed**



	1	2	3	4	5	6
RPM	82	106	123	148		190

QS Quick Service | 2-6 días laborables (tiempo de transporte no incluido)  
Quick Service | 2-6 dias úteis (tempo de transporte não incluido)



## Accesorios

### Acessórios

	125mm / 250mm bar		Included
	500mm bar	14 ○	<b>71-B940-14-14</b>
		05 ●	<b>71-B940-05-05</b>
		81 ●	<b>71-B940-81-81</b>
	White wall controller for DC motor	Light	<b>71-C340-14-14</b>
		Without Light	<b>71-C341-14-14</b>
	White wall controller for DC motor	Light	<b>71-C340-05-05</b>
		Without Light	<b>71-C341-05-05</b>



# Marinada NEW

Performance Collection



**Marinada**

	<b>BODY MAT</b> STEEL	<b>BLADES MAT</b> WOOD		<b>AIRFLOW</b> 147 m³/min	 20-32m²			<b>DC</b> MOTOR		
--	--------------------------	---------------------------	--	------------------------------	-------------	--	--	--------------------	--	--

**Structure**

Blanco Branco

**Reversible Blades**

Blanco Branco 14

Madera natural Madeira natural

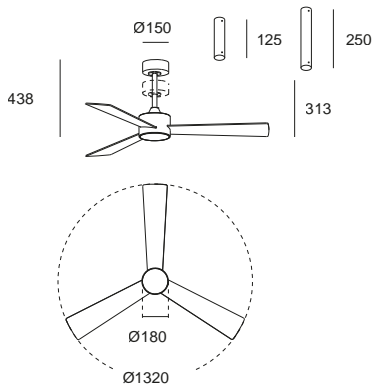

**LED**

W	Source	Code	Structure	Blades
35	220-240V	<b>30-A001 - 14</b>	<input type="radio"/>	<b>- 14</b> <input type="radio"/> <input checked="" type="radio"/>

Speed	1	2	3	4	5	6
RPM	112	140	165	187		223

**Accesorios**  
Acessórios

— 125mm / 250mm bar

Included



# BOSC

## Performance Collection



### Bosc

QS

BODY MAT AISI316	DIF MAT ACRYLIC	BLADES MAT WOOD	AIRFLOW 138 m³/min		 13-20m²			SWITCH CCT 3000/4000/5000K	 DIM	DC MOTOR		
---------------------	--------------------	--------------------	-----------------------	--	-------------	--	--	-------------------------------	---------	-------------	--	--

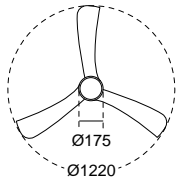
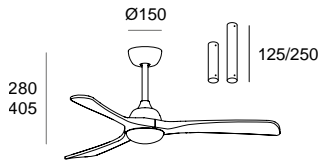

Negro Preto NEG ●  
Nogal Nogueira ●

### LED

W	CRI	K	Real Lm	Source	Code	Structure	Blades
50	80	3000	2875	100-240VAC	VE-0092 - NEG ●	●	●
		4000					
		5000					

El flujo indicado por cada óptica corresponde al de 4000K de Temperatura de color.  
The luminous flux indicated for each optic corresponds to that of a 4000K color temperature.

Speed	1	2	3	4	5	6
RPM	91	108	134	156		200

QS Quick Service | 2-6 días laborables (tiempo de transporte no incluido)  
Quick Service | 2-6 días úteis (tempo de transporte não incluido)

### Accesorios Acessórios

	125mm / 250mm bar		Included
	500mm bar	05 ●	71-B940-05-05
	Black wall controller for DC motor with light	14 ○	71-C340-14-14
	White wall controller for DC motor with light	05 ●	71-C340-05-05



# Pam

## Performance Collection



<b>Pam</b> QS	BODY MAT	DIF MAT	BLADES MAT	AIRFLOW					SWITCH CCT		DC		
	AISI316	ACRYLIC		149 m³/min					20-32m²		3000/4000/5000K		

Blanco Branco BLA

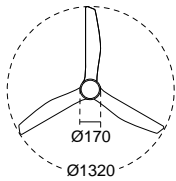
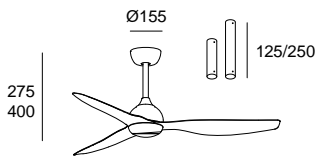

### LED

W	CRI	K	Real Lm	Source	Code	Structure	Blades
		3000					
50		4000	2875	100-240VAC	VE-0091 - BLA	<input type="radio"/>	<input type="radio"/>
		5000					

El flujo indicado por cada óptica corresponde al de 4000K de Temperatura de color.  
The luminous flux indicated for each optic corresponds to that of a 4000K color temperature.

Speed	1	2	3	4	5	6
RPM	85	109	124	145		193

QS Quick Service | 2-6 días laborables (tiempo de transporte no incluido)  
Quick Service | 2-6 dias úteis (tempo de transporte não incluido)

### Accesorios Acessórios

	125mm / 250mm bar		Included
	500mm bar	14 <input type="radio"/>	71-B940-05-05
	Black wall controller for DC motor with light	14 <input type="radio"/>	71-C340-14-14
	White wall controller for DC motor with light	05 <input checked="" type="radio"/>	71-C340-05-05



# Helix

## Performance Collection



### Helix

QS

BODY MAT STEEL	DIF MAT GLASS	BLADES MAT ABS	AIRFLOW 139 m³/min		 20-32m²			SWITCH CCT 3000/4000/5000K	 DIM	DC MOTOR		
-------------------	------------------	-------------------	-----------------------	--	-------------	--	--	-------------------------------	---------	-------------	--	--

Blanco Branco BLA

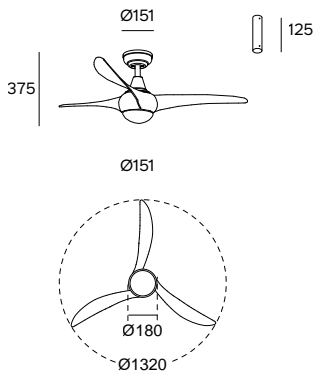

### LED

W	CRI	K	Real Lm	Source	Code	Structure	Blades
		3000					
50		4000	2875	100-240VAC	<b>VE-0094 - BLA</b>	<input type="radio"/>	<input type="radio"/>
		5000					

El flujo indicado por cada óptica corresponde al de 4000K de Temperatura de color.  
The luminous flux indicated for each optic corresponds to that of a 4000K color temperature.

Speed	1	2	3	4	5	6
RPM	78	98	118	136		180

QS Quick Service | 2-6 días laborables (tiempo de transporte no incluido)  
Quick Service | 2-6 días úteis (tempo de transporte não incluido)

### Accesorios

#### Acessórios

	125mm / 250mm bar		Included
	500mm bar	14 <input type="radio"/>	<b>71-B940-05-05</b>
	Black wall controller for DC motor with light	14 <input type="radio"/>	<b>71-C340-14-14</b>
	White wall controller for DC motor with light	05 <input checked="" type="radio"/>	<b>71-C340-05-05</b>



# Bora

## Essential Collection

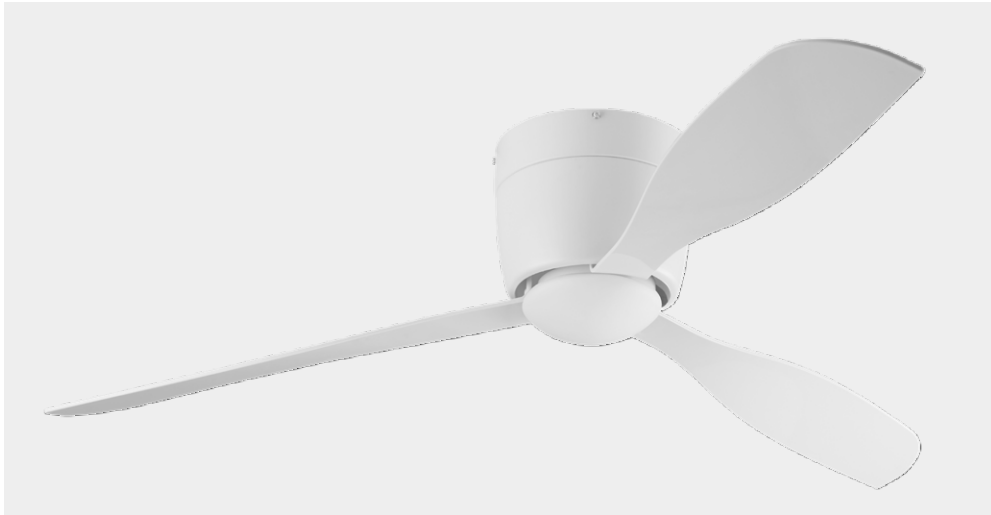

BODY MAT	DIF MAT	BLADES MAT		AIRFLOW			DC		
STEEL	GLASS	POLYCARBONATE		116 m³/min			MOTOR		

### Bora Ø988

QS

<13m²

Blanco Branco 14-F9

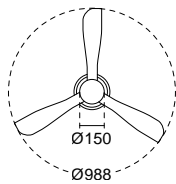
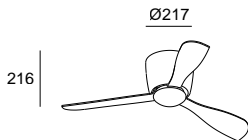

#### LED

W	CRI K	Real Lm	Source	Side	Code	Structure	Blades
38.1	3000	1800	100-240VAC	Ø 988	30-7973	- 14 <input type="radio"/>	- F9 <input type="radio"/>

#### Speed

	1	2	3	4	5
RPM	160	175	190	215	

### Bora Ø1235

QS

13-20m²	SWITCH CCT 2700/4000/6000K	DIM
---------	-------------------------------	-----

Blanco Branco BLA

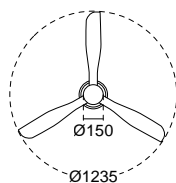
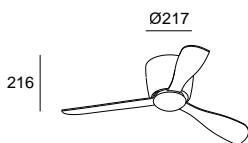

#### LED

W	CRI K	Real Lm	Source	Side	Code	Structure	Blades
57.7	4000	975	100-240VAC	Ø 1235	VE-0090	- BLA <input type="radio"/>	<input type="radio"/>
	2700						
	6000						

El flujo indicado por cada óptica corresponde al de 4000K de Temperatura de color.  
The luminous flux indicated for each optic corresponds to that of a 4000K color temperature.

#### Speed

	1	2	3	4	5
RPM	160	175	190	215	



# Calar

Essential Collection



## Calar

QS

BODY MAT STEEL / AL	DIF MAT METHACRYLATE	BLADES MAT FSC WOOD				DC MOTOR		
------------------------	-------------------------	------------------------	--	--	--	-------------	--	--

Blanco Branco BLA   
Madera natural Madeira natural

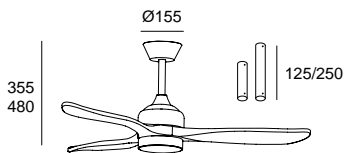

### LED

W	CRI K	Real Lm	Source	Side	Code	Structure	Blades
	3000			Ø 750	<b>VE-0022</b>		
38.1	4000	2570	200-240V	Ø 1066	<b>VE-0016</b>	- BLA <input type="radio"/>	<input checked="" type="radio"/>
	5000			Ø 1320	<b>VE-0023</b>		

El flujo indicado por cada óptica corresponde al de 4000K de Temperatura de color.  
The luminous flux indicated for each optic corresponds to that of a 4000K color temperature.

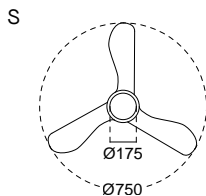

	AIRFLOW
<13m²	137 m³/min

Speed	1	2	3	4	5
RPM	83	147	213	283	

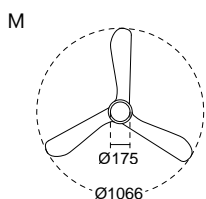

	AIRFLOW
13m²	131 m³/min

Speed	1	2	3	4	5
RPM	82	122	164	208	

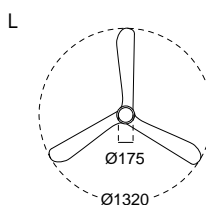

	AIRFLOW
20-32m²	159 m³/min

Speed	1	2	3	4	5
RPM	80	110	139	172	



Designed by Jordi Blasi

# Garbí

Performance Collection

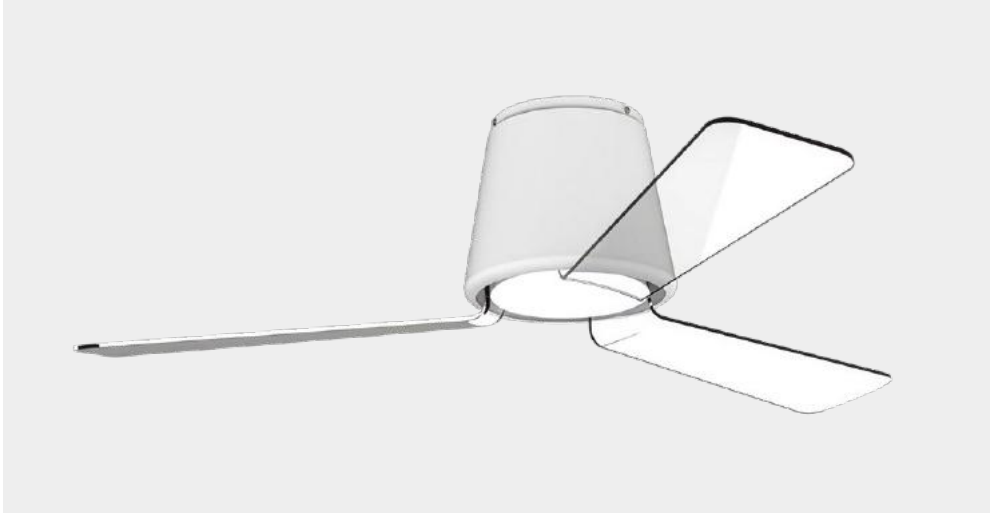

## Garbí

QS

BODY MAT	DIF MAT	BLADES MAT		IP	AIRFLOW			DC		
STEEL / AL	METHACRYLATE	ACRYLIC		44	175 m³/min	20-32m²		MOTOR		

Blanco Branco 14   
Transparente Transparente

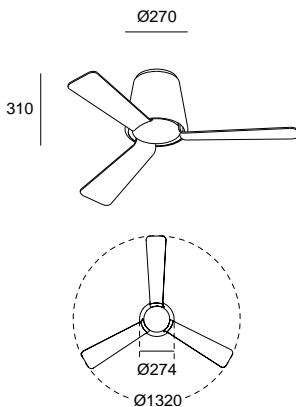

### LED

W	CRI	K	Real Lm	Source	Code	Structure	Blades
30		3000	608	100-240VAC	30-5378 - 14	<input type="radio"/>	- F9 <input type="radio"/>

Speed	1	2	3	4	5	6
RPM	110	138	165	193		223



# July

Essential Collection



July

QS

BODY MAT	DIF MAT	BLADES MAT		AIRFLOW				DC	SWITCH CCT		
STEEL / AL	METHACRYLATE	ABS		107 m³/min	13-20m²			MOTOR	3000/4000/5000K		

Blanco Branco NEG ●  
Madera natural Madeira natural ●

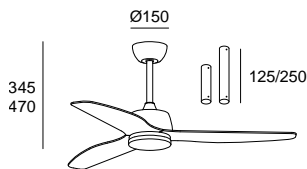

LED

W	CRI	K	Real Lm	Source	Code	Structure	Blades	
		3000						
47.5		4000	2570	100-240V	VE-0020 - NEG ●	●		266,80
		5000						

El flujo indicado por cada óptica corresponde al de 4000K de Temperatura de color.  
The luminous flux indicated for each optic corresponds to that of a 4000K color temperature.

Speed	1	2	3	4	5
RPM	83	112	140	173	

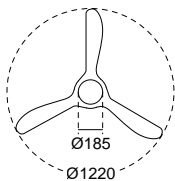



# Shadow

## Performance Collection



### Shadow

QS

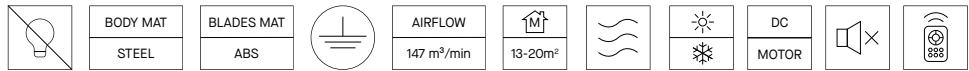

Negro Preto MAR ●  
Nogal oscuro Nogueira escura ●

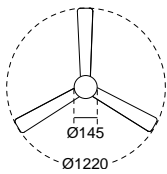
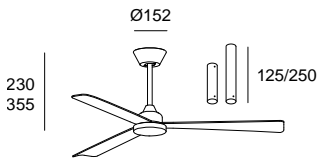

#### LED





W	Source	Code	Structure	Blades
30	100-240V	VE-0093 - MAR ●	●	●

Speed	1	2	3	4	5	6
RPM	103	128	150	167		223

QS Quick Service | 2-6 días laborables (tiempo de transporte no incluido)  
Quick Service | 2-6 dias úteis (tempo de transporte não incluído)

### Accesorios

#### Acessórios

	125mm / 250mm bar		Included
	500mm bar	05 ●	71-B940-05-05
	Black wall controller for DC motor without light	14 ○	71-C341-14-14
	White wall controller for DC motor without light	05 ●	71-C341-05-05



Designed by Jordi Blasi

# Zonda

Performance Collection

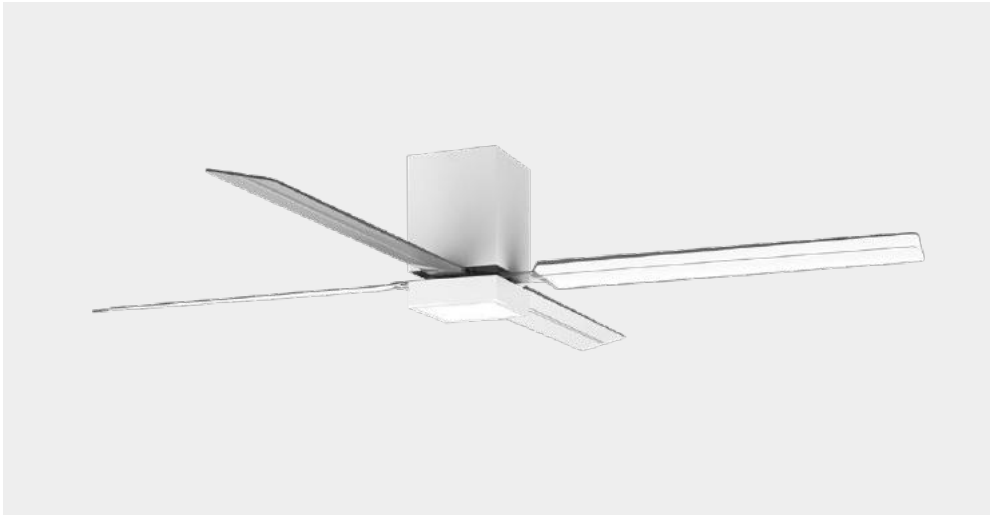

## Zonda

QS

BODY MAT STEEL	DIF MAT POLYCARBONATE	BLADES MAT POLYCARBONATE		AIRFLOW 187 m³/min	 20-32m²	 DC MOTOR		
-------------------	--------------------------	-----------------------------	--	-----------------------	-------------	--------------	--	--

Blanco Branco 14   
Transparente Transparente

### LED

W	CRI	K	Real Lm	Source	Code	Structure	Blades
51		3000	2076	100-240VAC	<b>30-8548 - 14</b> <input type="radio"/>	<input type="radio"/>	- M1 <input type="radio"/>

El flujo indicado por cada óptica corresponde al de 4000K de Temperatura de color.  
The luminous flux indicated for each optic corresponds to that of a 4000K color temperature.

Speed	1	2	3	4	5
RPM	98	118	135	145	

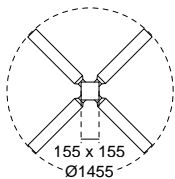
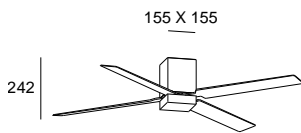



# Smart lighting

Una iluminación inteligente tiene el poder de generar emociones y contribuir al bienestar de las personas. Transforma y moldea espacios, convirtiéndolos en entornos flexibles y dinámicos. Capta información relevante sobre la instalación, clave para mejorar su rentabilidad.

A iluminação inteligente tem o poder de evocar emoções e contribuir para o bem-estar das pessoas. Transforma e molda espaços, tornando-os ambientes flexíveis e dinâmicos. Além disso, capta informação relevante sobre a instalação, essencial para melhorar a sua rentabilidade.



### Te ayudamos con tu idea

Nuestro equipo de especialistas de ayudará en la conceptualización de tu idea, ayudando a conseguir los hitos importantes para el proyecto, ya sean basados en el bienestar de las personas, en la flexibilidad de los espacios o bien en la eficiencia energética.

### Ajudamos a concretizar a sua ideia

A nossa equipa de especialistas irá auxiliá-lo na conceção da sua ideia, ajudando-o a alcançar os marcos importantes do projeto, sejam eles relacionados com o bem-estar das pessoas, a flexibilidade dos espaços ou a eficiência energética.

### Hacemos fácil lo difícil

Te acercamos la tecnología. Podemos integrar la tecnología en la propia luminaria premiando una instalación sencilla, o bien usando equipos de control centralizados que permiten maximizar las funcionalidades de control de iluminación.

### Simplificamos o complexo

Levamos a tecnologia até si. Podemos integrar a tecnologia diretamente na luminária, dando prioridade à facilidade de instalação, ou utilizar sistemas de controlo centralizados que maximizam as funcionalidades de controlo da iluminação.

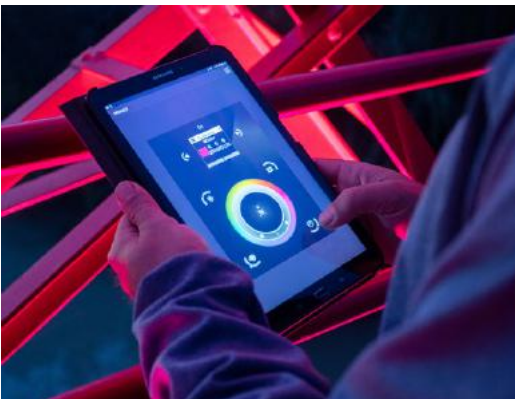

### Lo hacemos realidad

Configuramos la iluminación para conseguir los hitos marcados inicialmente ya sean de eficiencia energética, escenas lumínicas o de captación de datos. Dependiendo del proyecto, ofrecemos la preconfiguración en fábrica de la iluminación o bien in situ.

### Ajudamos a transformar a sua ideia em realidade

A nossa equipa de especialistas irá auxiliá-lo na conceção da sua ideia, ajudando a alcançar os principais objetivos do projeto, como o bem-estar das pessoas, a flexibilidade dos espaços e a eficiência energética.

### Te acompañamos

Estamos presentes durante el ciclo de vida de tu instalación y te formamos para que le puedas sacar el máximo rendimiento tanto a nivel lumínico como digital gracias a los datos que se pueden extraer de los sistemas.

### Simplificamos ou complicamos

Vamos levar a tecnologia ao extremo. Podemos integrar a tecnologia diretamente na luminária, dando prioridade à facilidade de instalação, ou utilizar sistemas de controlo centralizados que maximizem as funcionalidades de controlo da iluminação.



# Beneficios de la iluminación inteligente

## Benefícios da iluminação inteligente

### Flexibilidad y bienestar

Una iluminación de calidad con control inteligente crea espacios saludables, confortables y flexibles, adaptados a cada actividad y a los ritmos de las personas.

### Flexibilidade e bem-estar

Uma iluminação de qualidade com controlo inteligente cria espaços saudáveis, confortáveis e flexíveis, adaptados a cada atividade e aos ritmos das pessoas.

### Eficiencia y ahorro energético

La integración de iluminación eficiente y control inteligente permite reducir el consumo energético mediante el uso óptimo de la ocupación, la luz natural y los recursos disponibles.

### Eficiência e poupança energética

A integração de iluminação eficiente e controlo inteligente permite reduzir o consumo energético através da utilização otimizada da ocupação, da luz natural e dos recursos disponíveis.

### Color y emociones

El control avanzado de LedsC4 transforma el color en una herramienta emocional y comunicativa, capaz de gestionar miles de luminarias y universos DMX para crear experiencias luminicas dinámicas, coherentes y adaptadas a cada contexto.

### Cor e emoções

Os sistemas avançados de controlo da LedsC4 transformam a cor numa ferramenta emocional e comunicativa, capaz de gerir milhares de luminárias e universos DMX para criar experiências luminosas dinâmicas, coerentes e adaptadas a cada contexto.

### Servicios LedsC4

Ofrecemos acompañamiento integral en todas las fases del proyecto, desde el asesoramiento inicial y la documentación técnica hasta la ejecución en obra, asegurando que cada idea se haga realidad.

### Serviços LedsC4

Oferecemos um acompanhamento completo em todas as fases do projeto, desde o aconselhamento inicial e documentação técnica até à execução em obra, garantindo que cada ideia se concretiza.

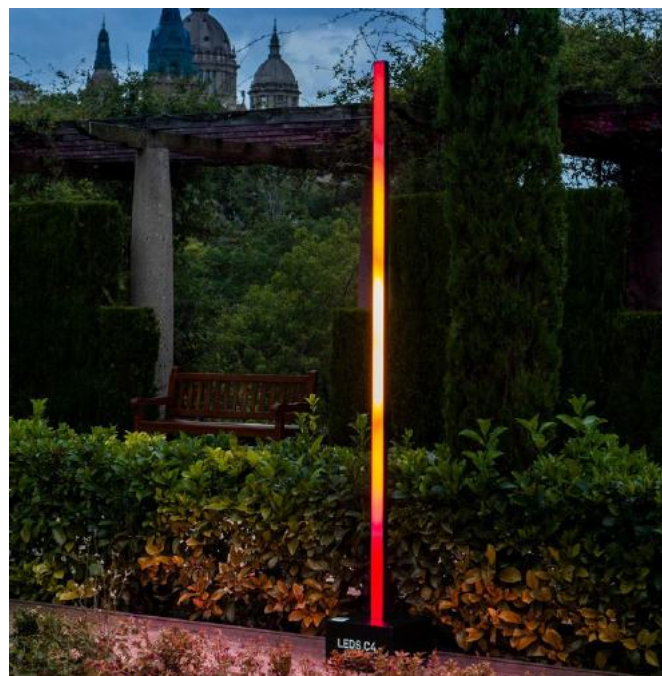

## Mantenimiento y uso de espacios

Los sistemas de control de LedsC4 convierten la iluminación en un subsistema estratégico, aportando datos de uso y estado que optimizan la eficiencia, la circularidad y el aprovechamiento inteligente de los espacios.

## Sostenibilidad y circularidad

La monitorización avanzada permite ajustar el consumo energético a las necesidades reales, optimizar el mantenimiento y alargar la vida útil de las luminarias, fomentando la circularidad y una gestión sostenible de los recursos.

## Créditos de certificaciones

La tecnología de LedsC4 facilita la obtención de créditos en certificaciones de edificios como LEED, BREEAM y WELL, ya que gracias al control inteligente de iluminación se puede mejorar el bienestar de las personas, el rendimiento energético y el aprovechamiento de los recursos.

## Extensión de garantía LedsC4

Accede a una extensión de garantía de los productos de LedsC4 al aplicar sistemas de gestión inteligente de la iluminación que permitan: la gestión horaria de los encendidos, control de las intensidades lumínicas y gestión automática mediante el uso de sensores de presencia y/o luminosidad.

## Manutenção e utilização dos espaços

Os sistemas de controlo da LedsC4 transformam a iluminação num subsistema estratégico, fornecendo dados de utilização e estado que otimizam a eficiência, a circularidade e o uso inteligente dos espaços.

## Sustentabilidade e circularidade

A monitorização avançada permite ajustar o consumo energético às necessidades reais, otimizar a manutenção e prolongar a vida útil das luminárias, promovendo uma gestão sustentável dos recursos.

## Créditos de certificação

A tecnologia da LedsC4 facilita a obtenção de créditos em certificações de edifícios como LEED, BREEAM e WELL, melhorando o bem-estar das pessoas, o desempenho energético e a utilização dos recursos.

## Extensão de garantia LedsC4

Aceda a uma extensão de garantia dos produtos LedsC4 através da implementação de sistemas inteligentes de gestão da iluminação que permitem a programação horária, o controlo dos níveis luminosos e a gestão automática com sensores de presença e/ou luminosidade.

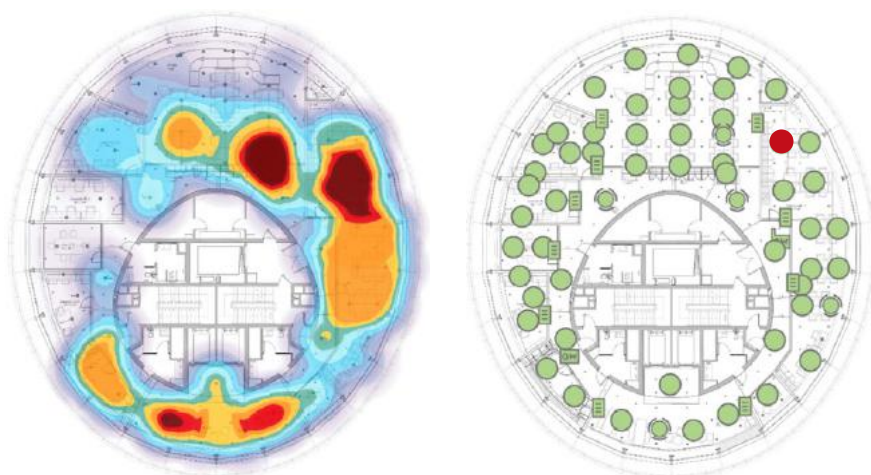

# DALI2

Solución para el control y la conectividad basada en el estándar DALI2.

Solução para o controlo e conectividade da Solução de controlo de iluminação baseada no standard DALI2.

## Funcionalidades

Permite conseguir, en una instalación, un gran ahorro energético mediante funcionalidades como gestión de luminarias punto a punto, grupos, escenas, control de luz constante, ciclo circadiano, control por ocupación y programaciones horarias, entre otras.

Permite conseguir, numa instalação, uma grande poupança energética mediante funcionalidades como gestão de luminárias ponto a ponto, grupos, cenas, controlo de luz constante, ciclo circadiano, controlo por ocupação e programações horárias, entre outras.



Parking BSM, Barcelona 2024.

### Elige la opción más adecuada a tu proyecto Escolha a opção mais adequada ao seu projeto

① 71-B102

② 71-B103

③ 71-B849

①



②

③

- Calendario, grupos, escenas, sensores de presencia y luminosidad  
Calendário, grupos, cenas, sensores de presença e luminosidade
- Ciclo circadiano y luminarias Tunnable White  
Ciclo circadiano e luminárias Tunnable White
- Compatible con licencia para luminarias de emergencia  
Compatível com licença para luminárias de emergência
- Compatible con licencia BACnet  
Compatível com licença BACnet
- Sistema sin límite de controladores  
Sistema sem limite de número de controladores
- Sistema compatible con servicios cloud para gestión del consumo y uso del espacio  
Sistema compatível com serviços em nuvem para a gestão de consumo e utilização do espaço





## Dispositivos de control DALI

### Dispositivos de controlo DALI

	<p>Controlador DALI2 Essential, hasta 192 dispositivos DALI2, permite control de escenas de iluminación y grupos, configuraciones horarias y de calendario, sensores de luminosidad y presencia, botoneras multifunción DALI2. Control Bacnet disponible bajo licencia. Instalación a carril DIN. Control de luminarias de emergencia DALI 2 disponible bajo licencia. 110-240V</p> <p>Controlador DALI2 Essential, até 192 dispositivos DALI2, permite o controlo de cenas de iluminação e grupos, configurações horárias e de calendário, sensores de luminosidade e presença, botoneiras multifunção DALI2. Controlo Bacnet disponível sob licença. Instalação em calha DIN. Controlo de luminárias de emergência DALI 2 disponível sob licença. 110-240V</p>	<b>71-B102-00-00</b>
	<p>Controlador DALI2 Performance, hasta 192 dispositivos DALI2, permite control de escenas de iluminación y grupos, configuraciones horarias y de calendario, sensores de luminosidad y presencia, botoneras multifunción DALI2. Incorpora la posibilidad de control de luminarias Tunnable White y Ciclo circadiano. Instalación a carril DIN. Control Bacnet disponible bajo licencia. 110-240V</p> <p>Controlador DALI2 Performance, até 192 dispositivos DALI2, permite o controlo de cenas de iluminação e grupos, configurações horárias e de calendário, sensores de luminosidade e presença, botoneiras multifunção DALI2. Incorpora a possibilidade de controlo de luminárias Tunnable White e Ciclo circadiano. Instalação em calha DIN. Controlo Bacnet disponível sob licença. 110-240V</p>	<b>71-B103-00-00</b>
	<p>Controlador DALI 2 Advance, hasta 256 luminarias DALI2 y 254 dispositivos de control DALI2 (sensores o botoneras), permite control de escenas de iluminación y grupos, configuraciones horarias y de calendario, sensores de luminosidad y presencia, botoneras multifunción DALI2. Incorpora la posibilidad de control de luminarias Tunnable White y Ciclo circadiano. Instalación a carril DIN. 220-240V</p> <p>Controlador DALI 2 Advance, até 256 luminárias DALI2 e 254 dispositivos de controlo DALI2 (sensores ou botoneiras), permite o controlo de cenas de iluminação e grupos, configurações horárias e de calendário, sensores de luminosidade e presença, botoneiras multifunção DALI2. Incorpora a possibilidade de controlo de luminárias Tunnable White e Ciclo circadiano. Instalação em calha DIN. 220-240V</p>	<b>71-B849-00-00</b>

## Pantallas de control

### Ecrãs de controlo

	<p>Pantalla controlador DALI2 7" Blanca, hasta 64 dispositivos DALI2 ampliable a 256 con la referencia 71-C012-00-00, permite control de escenas de iluminación y grupos, configuraciones horarias y de calendario, sensores de luminosidad y presencia, botoneras multifunción DALI2. Permite visualización calidad del aire. 24V o PoE.</p> <p>Ecrã do controlador DALI2 de 7" Branco, até 64 dispositivos DALI2, ampliável até 256 com a referência 71-C012-00-00, permite o controlo de cenas de iluminação e grupos, configurações horárias e de calendário, sensores de luminosidade e presença, botoneiras multifunção DALI2. Permite a visualização da qualidade do ar. 24V ou PoE.</p>	<b>71-B909-14-14</b>
	<p>Pantalla controlador DALI2 7" Negra, hasta 64 dispositivos DALI2 ampliable a 256 con la referencia 71-C012-00-00, permite control de escenas de iluminación y grupos, configuraciones horarias y de calendario, sensores de luminosidad y presencia, botoneras multifunción DALI2. Permite visualización calidad del aire. 24V o PoE.</p> <p>Ecrã do controlador DALI2 de 7" Preto, até 64 dispositivos DALI2, ampliável até 256 com a referência 71-C012-00-00, permite o controlo de cenas de iluminação e grupos, configurações horárias e de calendário, sensores de luminosidade e presença, botoneiras multifunção DALI2. Permite a visualização da qualidade do ar. 24V ou PoE.</p>	<b>71-B909-60-60</b>
	<p>Pantalla controlador DALI2 4" Blanca, hasta 64 dispositivos DALI2, permite control de escenas de iluminación y grupos, sensores de luminosidad y presencia, botoneras multifunción DALI2. Permite visualización Calidad del Aire. 24V o PoE.</p> <p>Ecrã do controlador DALI2 de 4" Branco, até 64 dispositivos DALI2, permite o controlo de cenas de iluminação e grupos, sensores de luminosidade e presença, botoneiras multifunção DALI2. Permite a visualização da qualidade do ar. 24V ou PoE.</p>	<b>71-B908-14-14</b>
	<p>Pantalla controlador DALI2 4" Negra, hasta 64 dispositivos DALI2, permite control de escenas de iluminación y grupos, sensores de luminosidad y presencia, botoneras multifunción DALI2. Permite visualización Calidad del Aire. 24V o PoE.</p> <p>Ecrã do controlador DALI2 4" Preto, até 64 dispositivos DALI2, permite o controlo de cenas de iluminação e grupos, sensores de luminosidade e presença, botoneiras multifunção DALI2. Permite a visualização da qualidade do ar. 24V ou PoE.</p>	<b>71-B908-60-60</b>
	<p>Extensión 3 buses DALI2 para pantalla 7", permite controlar hasta 192 dispositivos DALI2. 24VDC. 90mA + PoE.</p> <p>Extensão 3 buses DALI2 para ecrã de 7", permite controlar até 192 dispositivos DALI2. 24VDC. 90mA + PoE</p>	<b>71-C012-00-00</b>

## Fuentes de alimentación

### Fontes de alimentação

	Fuente de alimentación 24Vdc DALI2 para tiras de LED o luminarias regulables PWM, 1 canal de 60W. 100-230V Fonte de alimentação 24Vdc DALI2 para fitas LED ou luminárias reguláveis PWM, 1 canal de 60W. 100-230V	<b>71-E098-00-00</b>
	Fuente de alimentación 24Vdc DALI2 para tiras de LED o luminarias regulables PWM, 1 canal de 120W. 100-230V Fonte de alimentação 24Vdc DALI2 para fitas LED ou luminárias reguláveis PWM, 1 canal de 120W. 100-230V	<b>71-E099-00-00</b>
	Fuente de alimentación 24Vdc DALI2 Dt8 para tiras de LED tunnable white, 2 canales. 160W. 230V Fonte de alimentação 24Vdc DALI2 Dt8 para fitas LED tunnable white, 2 canais. 160W. 230V	<b>71-B401-00-00</b>
	Fuente de alimentación 24Vdc. 4 canales independientes, control DALI-2(DT6/DT8), DMX512/RDM. Máximo 150W. 220-240Vac. Fonte de alimentação 24Vdc. 4 canais independentes, controlo DALI-2(DT6/DT8), DMX512/RDM. Máximo 150W. 220-240Vac."	<b>71-C277-00-00</b>
	Fuente con salida 24V y 130mA. 230V Fonte com saída de 24V e 130mA. 230V	<b>71-C013-00-00</b>
	Fuente para 1 bus DALI2 a carril DIN. 120-240V Fonte para 1 bus DALI2 em calha DIN. 120-240V	<b>71-C014-00-00</b>
	Fuente de alimentación para Displays. IP20, 24Vdc, 300mA. Montaje a carril DIN. Fonte de alimentação para displays. IP20, 24Vdc, 300mA. Montagem em calha DIN.	<b>71-C278-00-00</b>





## Rele

### Relé

	Rele On Off DALI2 para luminarias LED, hasta 1380W, 6A. 230V Relé On Off DALI2 para luminárias LED, até 1380W, 6A. 230V	<b>71-B101-00-00</b>
---	--	----------------------

## Sensores

### Sensores

	Sensor de luminosidad y movimiento para instalación de empotrar DALI2. Diámetro detección 5m a altura 3m. De 0,5 – 2.000 lx de luminosidad. Alimentación directa bus DALI 9mA. Sensor de luminosidade e movimento para instalação de encastrar DALI2. Diâmetro de deteção 5 m e 3 m de altura. De 0,5 – 2.000 lx de luminosidade. Alimentação direta bus DALI 9mA.	<b>71-B098-00-00</b>
	Sensor de luminosidad y movimiento para instalación de superficie DALI2. Diámetro detección 5m a altura 3m. De 0,5 – 2.000 lx de luminosidad. Alimentación directa bus DALI 9mA. Sensor de luminosidade e movimento para instalação de superfície DALI2. Diâmetro de deteção 5 m e 3 m de altura. De 0,5 – 2.000 lx de luminosidade. Alimentação direta bus DALI 9mA.	<b>71-B100-00-00</b>
	Sensor DALI 2 para detección de movimiento. Diámetro detección 8m a altura de 3m. Alimentación directa del bus DALI consumo 10mA. Sensor DALI 2 para deteção de movimento. Diâmetro de deteção 8 m e 3 m de altura. Alimentação direta do bus DALI consumo 10mA.	<b>71-B876-00-00</b>
	Accesorio superficie Sensor 71-B876-00-00 Acessório superfície Sensor 71-B876-00-00	<b>71-B877-00-00</b>
	Multisensor luminosidad y presencia empotrar DALI2 advance. diametro de detección 8m. Alimentación directa bus DALI consumo 10mA. Multissensor luminosidade e presença de encastrar DALI2 advance. Diâmetro de deteção 8 m. Alimentação direta bus DALI consumo 10mA.	<b>71-B850-00-00</b>

## Botoneras

### Botoneiras

	<p>Conversor de señales libre de potencial, apto para incorporar pulsadores convencionales al entorno DALI2. Alimentación directa bus DALI 10mA.</p> <p>Conversor de sinais sem potencial, adequado para incorporar botões convencionais no ambiente DALI2. Alimentação direta do bus DALI 10mA.</p>	<b>71-B099-00-00</b>
	<p>Botonera 4 funciones acabado Negro DALI2. Alimentación directa bus DALI 10mA.</p> <p>Botoneira de 4 funções, acabamento Preto DALI2. Alimentação direta do bus DALI 10mA.</p>	<b>71-B756-60-60</b>
	<p>Botonera 4 funciones acabado Blanco DALI2. Alimentación directa bus DALI 10mA.</p> <p>Botoneira de 4 funções, acabamento Branco DALI2. Alimentação direta do bus DALI 10mA.</p>	<b>71-B756-14-14</b>

## Licencias

### Licenças

	<p>Licencia Bacnet 100 Variables para controlador 71-B102-00-00 o 71-B103-00-00</p> <p>Licença Bacnet 100 Variáveis para o controlador 71-B102-00-00 ou 71-B103-00-00</p>	<b>71-B830-00-00</b>
	<p>Licencia Bacnet 1000 Variables para controlador 71-B102-00-00 o 71-B103-00-00</p> <p>Licença Bacnet 1000 Variáveis para o controlador 71-B102-00-00 ou 71-B103-00-00</p>	<b>71-B831-00-00</b>
	<p>Licencia DALI2 Emergencia 100 luminarias 71-B102-00-00 o 71-B103-00-00</p> <p>Licença DALI2 Emergência 100 luminárias 71-B102-00-00 ou 71-B103-00-00</p>	<b>71-B117-00-00</b>

# Bluetooth Casambi

Solución de control de iluminación basada en el protocolo Bluetooth Mesh con control directo desde Smartphone o Tablet, sin necesidad de añadir ningún elemento adicional. La facilidad de uso del sistema permite que sea válida para cualquier usuario. Su aplicación es ideal para entornos flexibles y dinámicos, donde se requiera una gran interacción con las luminarias.

Solução de controlo de iluminação baseada no protocolo Bluetooth Mesh com controlo direto desde Smartphone ou Tablet, sem necessidade de adicionar nenhum elemento adicional. A facilidade de uso do sistema permite que seja válida para qualquer utilizador. A sua aplicação é ideal para ambientes flexíveis e dinâmicos, onde seja necessária uma grande interação com as luminárias.



Brondesbury Park Synagogue, London 2022.

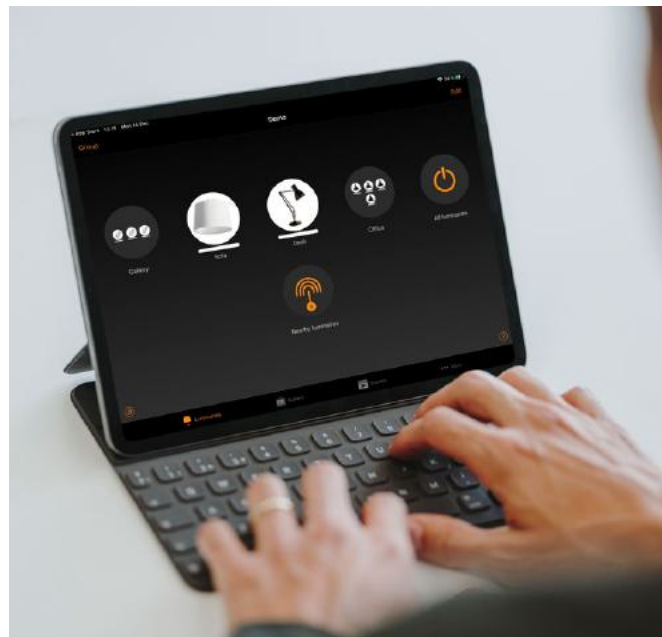

## Funcionalidades Funcionalidades













- Control individual de las luminarias y regulación punto a punto  
Controlo individual das luminárias e regulação ponto a ponto
- Creación de grupos de luminarias  
Criação de grupos de luminárias
- Regulación según calendario  
Regulação segundo calendário
- Control de la temperatura de color  
Controlo da temperatura de cor
- Ciclo circadiano  
Ciclo circadiano
- Regulación según nivel de luz natural  
Regulação segundo o nível de luz natural

## Dispositivos Bluetooth Casambi

### Dispositivos Bluetooth Casambi

#### Controladores / conversores

#### Controladores / conversores











	<p>Convertor Casambi para productos regulables corte de fase <i>trailing edge</i>. Máximo 144W, Máximo inrush current 10A. 85-240Vac.</p> <p>Convertor Casambi para produtos reguláveis com corte de fase <i>trailing edge</i>. Máximo 144W, Máximo inrush current 10A. 85-240Vac.</p>	<b>71-5959-00-00</b>
	<p>Convertor Casambi para productos regulables 0-10V o DALI. Hasta 2 drivers DALI, o 1 driver 0-10V. 230Vac.</p> <p>Convertor Casambi para produtos reguláveis 0-10V ou DALI. Até 2 drivers DALI, ou 1 driver 0-10V. 230Vac.</p>	<b>71-5961-00-00</b>
	<p>Convertor Casambi para productos regulables 0-10V o DALI. Hasta 1 driver DALI o 2 drivers 0-10V. 100-240Vac.</p> <p>Convertor Casambi para produtos reguláveis 0-10V ou DALI. Até 1 driver DALI ou 2 drivers 0-10V. 100-240Vac.</p>	<b>71-B669-00-00</b>
	<p>Convertor Casambi a DALI, hasta 50 luminarias. Permite controlarlas simultáneamente o hasta en 8 grupos si se realiza un direccionamiento DALI adicional. 100-240Vac.</p> <p>Convertor Casambi para DALI, até 50 luminárias. Permite serem controladas simultaneamente ou até em 8 grupos, se for realizado um direccionamento DALI adicional. 100-240Vac.</p>	<b>71-B855-00-00</b>
	<p>Relé Casambi, para cargas LED de máximo 1500W. 100-240Vac.</p> <p>Relé Casambi, para cargas LED de 1500W máximo. 100-240Vac.</p>	<b>71-A300-00-00</b>
	<p>Convertor pasivo Casambi integrar sensores DALI o para controlar drivers DALI con fuente integrada.</p> <p>Convertor passivo Casambi para integrar sensores DALI ou para controlar drivers DALI com fonte integrada.</p>	<b>71-8051-00-00</b>
	<p>Convertor Casambi a DALI Broadcast IP66. 100-240Vac.</p> <p>Convertor Casambi para DALI Broadcast IP66. 100-240Vac.</p>	<b>71-A237-00-00</b>
	<p>Convertor Casambi a DMX Broadcast IP66. 100-240Vac.</p> <p>Convertor Casambi para DMX Broadcast IP66. 100-240Vac.</p>	<b>71-A238-00-00</b>
	<p>Convertor Casambi a DALI para sistemas de carril "low voltage". Hasta 64 dispositivos DALI. Permite controlarlas simultáneamente "broadcast" o hasta en 8 grupos si se realiza direccionamiento DALI adicional. 48V</p> <p>Convertor Casambi para DALI para sistemas de calha "low voltage". Até 64 dispositivos DALI. Permite serem controlados simultaneamente "broadcast" ou até em 8 grupos, se for realizado um direccionamento DALI adicional. 48V</p>	<b>71-8115-00-00</b>
	<p>Convertor Casambi a DALI acabado blanco para sistemas de carril trifásicos. Hasta 64 dispositivos. Permite controlarlas simultáneamente "Broadcast". 100-240Vac.</p> <p>Convertor Casambi para DALI, acabamento branco para sistemas de calha trifásica. Até 64 dispositivos. Permite serem controlados simultaneamente "Broadcast". 100-240Vac.</p>	<b>71-A243-14-14</b>
	<p>Convertor Casambi a DALI acabado negro para sistemas de carril trifásicos. Hasta 64 dispositivos. Permite controlarlas simultáneamente "Broadcast". 100-240Vac.</p> <p>Convertor Casambi para DALI, acabamento preto para sistemas de calha trifásica. Até 64 dispositivos. Permite serem controlados simultaneamente "Broadcast". 100-240Vac.</p>	<b>71-A243-60-60</b>
	<p>Convertor Casambi a DALI acabado blanco para sistemas DALI. Permite controlar hasta 16 dispositivos. Permite controlarlas individualmente. Requiere fuente de alimentación externa para el bus DALI.</p> <p>Convertor Casambi para DALI acabamento branco para sistemas DALI. Permite controlar até 16 dispositivos. Permite controlá-los individualmente. Requer fonte de alimentação externa para o barramento DALI.</p>	<b>71-C274-00-00</b>
	<p>Convertor Casambi a DALI acabado blanco para sistemas DALI. Permite controlar hasta 32 dispositivos. Permite controlarlas individualmente. Requiere fuente de alimentación externa para el bus DALI.</p> <p>Convertor Casambi para DALI acabamento branco para sistemas DALI. Permite controlar até 32 dispositivos. Permite controlá-los individualmente. Requer fonte de alimentação externa para o barramento DALI.</p>	<b>71-C275-00-00</b>

## Dispositivos Bluetooth Casambi

### Dispositivos Bluetooth Casambi





#### Controladores Bajo voltaje

#### Controladores Baixa tensão

	Regulador Casambi para tiras LED y productos a tensión constante 12-24Vdc. 1 canal. Dispone de entrada pulsador. Máximo 10A. Requiere fuente de alimentación. Regulador Casambi para fitas LED e produtos de tensão constante 12-24Vdc. 1 canal. Possui uma entrada de botão. Máximo 10A. Necessário fonte de alimentação.	<b>71-A857-00-00</b>
	Fuente Casambi IP20 para tiras LED y productos a tensión constante 24Vdc. 1 canal. Máximo 60W. 220-240V Fonte Casambi IP20 para fitas LED e produtos de tensão constante 24Vdc. 1 canal. Máximo 60W. 220-240V	<b>71-B864-00-00</b>
	Fuente Casambi IP20 para tiras LED y productos a tensión constante 24Vdc. 1 canal. Máximo 100W. 220-240V Fonte Casambi IP20 para fitas LED e produtos de tensão constante 24Vdc. 1 canal. Máximo 100W. 220-240V	<b>71-B865-00-00</b>
	Fuente Casambi IP20 para tiras LED y productos a tensión constante 24Vdc. 1 canal. Máximo 150W. 220-240V Fonte Casambi IP20 para fitas LED e produtos de tensão constante 24Vdc. 1 canal. Máximo 150W. 220-240V	<b>71-B866-00-00</b>
	Fuente Casambi IP67 para tiras LED y productos a tensión constante 24Vdc. 1 canal. Máximo 60W. 90-305Vac. Fonte Casambi IP67 para fitas LED e produtos de tensão constante 24Vdc. 1 canal. Máximo 60W. 90-305Vac.	<b>71-B670-00-00</b>
	Fuente Casambi IP67 para tiras LED y productos a tensión constante 24Vdc. 1 canal. Máximo 120W. 90-305Vac. Fonte Casambi IP67 para fitas LED e produtos de tensão constante 24Vdc. 1 canal. Máximo 120W. 90-305Vac.	<b>71-A242-00-00</b>
	Fuente Casambi IP67 para tiras LED y productos a tensión constante 24Vdc. 1 canal. Máximo 200W. 90-305Vac. Fonte Casambi IP67 para fitas LED e produtos de tensão constante 24Vdc. 1 canal. Máximo 200W. 90-305Vac.	<b>71-B671-00-00</b>
	Regulador Casambi para tiras LED y productos a tensión constante 12-24Vdc. 4 canales. Máximo 144W. Requiere fuente de alimentación. Apto para productos tunable white, RGB y RGBW. Regulador Casambi para fitas LED e produtos de tensão constante 12-24Vdc. 4 canais. Máximo 144W. Necessário fonte de alimentação. Adequado para produtos tunable white, RGB e RGBW.	<b>71-8050-00-00</b>
	Caja IP con regulador Casambi para tiras LED y productos a tensión constante 12-24Vdc. 4 canales. Máximo 144W. Apto para productos tunable white, RGB y RGBW. 90-295Vac. Caixa IP com regulador Casambi para fitas LED e produtos de tensão constante 12-24Vdc. 4 canais. Máximo 144W. Adequado para produtos tunable white, RGB e RGBW. 90-295Vac.	<b>71-E300-00-00</b>
	Regulador Casambi para tiras LED y productos a tensión constante 12-24Vd. 4 canales 4x5A. Máximo 10A. Requiere fuente de alimentación. Apto para productos tunable white, RGB y RGBW. Regulador Casambi para fitas LED e produtos de tensão constante 12-24Vd. 4 canais 4x5A. Máximo 10A. Necessário fonte de alimentação. Adequado para produtos tunable white, RGB e RGBW.	<b>71-B672-00-00</b>

#### Botoneras

#### Botoneiras





	Botonera 4 funciones acabado Antracita Enocean. Botoneira de 4 funções com acabamento Antracite Enocean.	<b>71-B673-00-00</b>
	Botonera 4 funciones acabado Blanco Enocean. Botoneira de 4 funções com acabamento Branco Enocean.	<b>71-B674-00-00</b>
	Botonera Casambi 4 funciones más regulación acabado negro. Batería CR2430. Botoneira Casambi de 4 funções mais regulação com acabamento preto. Batería CR2430.	<b>71-8053-00-00</b>
	Botonera Casambi 4 funciones más regulación acabado blanco. Batería CR2430. Botoneira Casambi de 4 funções mais regulação com acabamento branco. Batería CR2430.	<b>71-A240-00-00</b>
	Botonera 1 función acabado Blanco Enocean. Botoneira de 1 função com acabamento Branco Enocean.	<b>71-B113-00-00</b>

## Dispositivos Bluetooth Casambi

### Dispositivos Bluetooth Casambi





#### Sensores

#### Sensores

	Accesorio para instalación en superficie del sensor 71-8049-00-00 Acessório para instalação na superfície do sensor 71-8049-00-00	<b>71-B743-00-00</b>
	Sensor de presencia y luminosidad Casambi. IP40. Diámetro detección 6m a altura 3m. De 1 – 2.000 lx de luminosidad. 230V Sensor de presença e luminosidade Casambi. IP40. Diâmetro de deteção 6 m e 3 m de altura. De 1 – 2.000 lx de luminosidade. 230V	<b>71-8049-00-00</b>
	Sensor de presencia y luminosidad Casambi con salida DALI incorporada de hasta 10 luminarias. Diámetro detección 5,6m a altura 3m. De 1 – 999 lx de luminosidad IP40. 230V Sensor de presença e luminosidade Casambi com saída DALI incorporada de até 10 luminárias. Diâmetro de deteção 5,6 m e 3 m de altura. De 1 – 999 lx de luminosidade IP40. 230V	<b>71-A696-00-00</b>
	Sensor de presencia y luminosidad Casambi a carril trifásico, acabado negro. Diámetro detección 3,75m a altura 3m. 230V Sensor de presença e luminosidade Casambi para calha trifásica, acabamento preto. Diâmetro de deteção 3,75 m e 3 m de altura. 230V	<b>71-A241-60-60</b>
	Sensor de presencia y luminosidad Casambi a carril trifásico, acabado blanco. Diámetro detección 3,75m a altura 3m. 230V Sensor de presença e luminosidade Casambi para calha trifásica, acabamento branco. Diâmetro de deteção 3,75 m e 3 m de altura. 230V	<b>71-A241-14-14</b>

#### Adicionales

#### Adicionais

	Router Gateway Wifi para conexión a cloud Casambi de la red. Apto para dotar de acceso remoto a la red y asegurar funcionamiento de las programaciones horarias y de calendario. 5V DC via USB-C (3A) o PoE. Router Gateway Wi-fi para ligação à cloud Casambi na rede. Adequado para fornecer acesso remoto à rede e assegurar o funcionamento das programações horárias e calendário. 5V DC via USB-C (3A) ou PoE.	<b>71-B750-00-00</b>
	Timer Casambi para garantizar el funcionamiento de las programaciones horarias. Timer Casambi para garantir o funcionamento das programações horárias.	<b>71-8052-00-00</b>
	Caja estanca con dos prensaestopas M20 para entrada y salida y protección IP66 (IP68 no permanente). Almacenaje para los controladores Casambi 71- 5961-00-00, 71-B855-00-00, 71-A300-00-00. Tensión máxima 400Vac. Aislamiento 2500Vac. Material PA66 con tratamiento anti-UV. Resistencia al fuego UL94 V-0. Caixa estanque com duas prensa-cabos M20 para entrada e saída e proteção IP66 (IP68 não permanente). Armazenamento para os controladores Casambi 71-5961-00-00, 71-B855-00-00, 71-A300-00-00. Tensão máxima 400Vac. Isolamento 2500Vac. Material PA66 com tratamento anti-UV. Resistência ao fogo UL94 V-0.	<b>71-C351-00-00</b>
	Repetidor Casambi con alcance maximo de 150m. Protección IP20. Carcasa de policarbonato blanco. Repetidor Casambi com alcance máximo de 150m. Proteção IP20. Caixa de policarbonato branco.	<b>71-C352-00-00</b>

# DMX

Sistema de control DMX que permite una gestión de la iluminación dinámica con unas transiciones de color a alta velocidad, permitiendo incluso un posible control punto a punto de cada luminaria.

Sistema de controlo DMX que permite a gestão dinâmica da iluminação com transições de cor de alta velocidade, permitindo inclusive o controlo ponto a ponto de cada luminária.

## Funcionalidades



Puente de los Remedios, Villafranca de Cordoba 2022

Elige la opción más adecuada a tu proyecto  
Escolha a opção mais adequada ao seu projeto

- ① 71-B115
- ② 71-B116
- ③ 71-B667
- ④ 71-C271

①



②

③

④

- Control Luminarias DMX RGB o RGBW  
Controlo Luminárias DMX RGB ou RGBW
- 1 universo DMX-RDM 512  
1 universo DMX-RDM 512
- Wifi
- 36 Escenas  
36 Cenas
- Programaciones horarias y calendario  
Programações horárias e calendário
- Programación por APP  
Programação por APP
- 2 universos DMX-RDM 1024  
2 universos DMX-RDM 1024
- Hasta 500 escenas  
Até 500 cenas
- Ethernet
- Acceso remoto  
Acesso remoto
- Gestión de contenidos / Luminarias pixel  
Gestão de conteúdos / Luminárias pixel



## Controladores de pared DMX

	Pantalla táctil DMX básica no programable. Controla simultáneamente "Broadcast" luminarias DMX. Permite guardar 4 colores. Instalacion en caja universal de mecanismos de 65x65. 100-240V Ecrã tátil DMX básico, não programável. Controla simultaneamente "Broadcast" luminárias DMX. Permite guardar 4 cores. Instalação numa caixa universal de derivação de 65x65. 100-240V	<b>71-7666-00-00</b>
	Consola táctil DMX RDM programable. 512 canales DMX. WiFi. 36 escenas, 1 zona. Control horario y por calendario. Requiere conocimientos de programación DMX, no permite acceso remoto. Consola tátil DMX RDM programável. 512 canais DMX. Wi-fi. 36 cenas, 1 zona. Controlo horário e por calendário. Requer conhecimentos de programação DMX, não permite o acesso remoto.	<b>71-B115-00-00</b>
	Consola táctil DMX RDM programable. 1024 canales DMX. Puerto ethernet. 500 escenas, 10 zonas. microSD. Control horario y por calendario. Requiere conocimientos de programación DMX. No permite acceso remoto. Consola tátil DMX RDM programável. 1024 canais DMX. Porta Ethernet. 500 cenas, 10 zonas. microSD. Controlo horário e por calendário. Requer conhecimentos de programação DMX. Não permite o acesso remoto.	<b>71-B116-00-00</b>



**Divisores de señal****Divisores de sinal**

	Derivador y amplificador DMX RDM. 4 canales. Instalación a carril DIN. Requiere fuente de alimentación 12Vdc. Derivador e amplificador DMX RDM. 4 canais. Instalação em calha DIN. Necessário fonte de alimentação 12Vdc.	<b>71-B125-00-00</b>
	Derivador y amplificador DMX RDM. 10 canales. Instalación en Rack. 100-240Vac. Derivador e amplificador DMX RDM. 10 canais. Instalação em Rack. 100-240Vac.	<b>71-B668-00-00</b>
	Fuente de alimentación salida 12Vdc. 230Vac. Fonte de alimentação saída 12Vdc. 230Vac.	<b>71-B416-00-00</b>



**Reguladores****Reguladores**

	Controlador DMX-RDM PWM para tiras LED y producto a tensión constante 12-24V, 5 canales de 8A. Requiere fuente de alimentación. Puertos RJ45, XLR y de tornillo. Dispone de modo esclavo DMX o de modo master para funcionamiento autónomo. Controlador DMX-RDM PWM para fitas LED e produtos com tensão constante 12-24V, 5 canais de 8A. Necessário fonte de alimentação. Portas RJ45, XLR e de parafuso. Possui modo escravo DMX ou modo master para funcionamento autónomo.	<b>71-B755-00-00</b>
	Fuente de alimentación 24Vdc. 4 canales independientes, control DALI-2 (DT6/DT8), DMX512/RDM. Máximo 150W. 220-240Vac. Fonte de alimentação 24Vdc. 4 canais independentes, controlo DALI-2(DT6/DT8), DMX512/RDM. Máximo 150W. 220-240Vac"	<b>71-C277-00-00</b>
	Convertor DMX RDM a SPI para control de tiras LED pixel SPI. 128 canales. Convertor DMX RDM para SPI para controlo de fitas LED com pixel SPI. 128 canais.	<b>71-B853-00-00</b>







**Controlador con posibilidad de acceso remoto****Controlador com possibilidade de acesso remoto**

	Consola DMX-RDM programable. 1536 canales DMX. 99 escenas, 5 zonas. Ethernet. microSD. Servicio cloud disponible no incluido para la gestión remota de la instalación. Requiere conocimientos de programación DMX. Instalación a carril DIN. 12V dc. Consola DMX-RDM programável. 1536 canais DMX. 99 cenas, 5 zonas. Ethernet. microSD. Serviço cloud disponível, mas não incluído, para a gestão remota da instalação. Requer conhecimentos de programação DMX. Instalação em calha DIN. 12V dc.	<b>71-B667-00-00</b>
	Pantalla táctil 7" negra, para control DMX compatible con controlador 71-B667-00-00. USB-A Ethernet RJ45 WiFi (2,4 GHz), 1024x600. 9V DC (incorporado). Ecrã tátil 7" preto para controlo DMX compatível com o controlador 71-B667-00-00. USB-A Ethernet RJ45 Wi-fi (2,4 GHz), 1024x600. 9V DC (incorporado).	<b>71-B863-00-00</b>

**Accesos Cloud****Acessos Cloud**

	Servicio Digital Cloud DMX Connect Essential, Anual. Serviço Digital Cloud DMX Connect Essential, anual.	<b>SV-D0101</b>
	Servicio Digital Cloud DMX Connect Performance Anual. Serviço Digital Cloud DMX Connect Performance Anual.	<b>SV-D0102</b>

**Gestión de contenidos Madrix****Gestão de conteúdos Madrix**

	Controlador Artnet-SPI Madrix Nebula. 12 universos SPI (hasta 2048 RGB píxeles por dispositivo). Entradas Art-Net, sACN y USB. Instalación carril DIN, 5-24 V Controlador Artnet-SPI Madrix Nebula. 12 universos SPI (até 2048 RGB píxeis por dispositivo). Entradas Art-Net, sACN e USB. Instalação calha DIN, 5-24 V	<b>71-C268-00-00</b>
	Controlador Artnet-DMX. 2 universos DMX (hasta 1024 canales). Entradas/salidas Art-Net, sACN y USB. Instalación carril DIN, 5-24 V Controlador Artnet-DMX. 2 universos DMX (até 1024 canais). Entradas/salidas Art-Net, sACN e USB. Instalação calha DIN, 5-24 V	<b>71-C269-00-00</b>
	Controlador StandAlone Madrix Aura. 2 universos DMX (hasta 1024 canales). Entradas/salidas Art-Net, sACN y USB. Instalación carril DIN, 5-24 V Controlador StandAlone Madrix Aura. 2 universos DMX (até 1024 canais). Entradas/salidas Art-Net, sACN e USB. Instalação calha DIN, 5-24 V	<b>71-C270-00-00</b>
	Controlador StandAlone Madrix Aura. 12 universos DMX (hasta 6.144 canales). Grabación de secuencias Art-Net/ sACN mediante microSD. Instalación carril DIN, 5-24 V Controlador Stand-Alone Madrix Aura. 12 universos DMX (até 6144 canais). Gravação de sequências Art-Net/ sACN mediante microSD. Instalação calha DIN, 5-24 V	<b>71-C271-00-00</b>
	Controlador StandAlone Madrix Aura. 12 universos DMX (hasta 6.144 canales). Grabación de secuencias Art-Net/ sACN mediante microSD. Instalación carril DIN, 5-24 V Controlador Stand-Alone Madrix Aura. 12 universos DMX (até 6144 canais). Gravação de sequências Art-Net/ sACN mediante microSD. Instalação calha DIN, 5-24 V	<b>71-C280-00-00</b>
	Licencia básica de software MADRIX para control avanzado de iluminación LED. Conexión vía USB. Licença básica de software MADRIX para controlo avançado de iluminação LED. Ligação via USB.	<b>71-C272-00-00</b>
	Licencias para Madrix en función de los universos DMX. A consultar. Licenças MADRIX baseadas nos universos DMX. Consultar o departamento técnico.	

# Standalone

Soluciones de control autónomas. Pueden utilizarse para controlar una o varias luminarias dentro de un mismo espacio de forma autónoma. Con las soluciones Standalone podemos realizar funciones sencillas y conseguir un gran ahorro energético.

Soluções de controlo autónomas. Podem ser utilizadas para controlar uma ou várias luminárias dentro de um mesmo espaço de forma autónoma. Com as soluções Standalone podemos realizar funções simples e conseguir uma grande poupança energética.



## Institut Vilabreix, 2022

Gracias a la incorporación de sensores autónomos, la iluminación se regula en función del aporte de luz natural, favoreciendo el ahorro energético.

Graças à incorporação de sensores autónomos, a iluminação é regulada de acordo com o fornecimento de luz natural, favorecendo a poupança energética.

## Botoneras y regulador DALI para instalación en caja universal de mecanismos

Botoneiras e regulador DALI para instalação numa caixa universal de mecanismos



Pantalla táctil RGBW PWM para regular 1 zona para tiras LED y producto a tensión constante 12-24V, 4 canales de 5A. Permite guardar 4 colores. Requiere fuente de alimentación. Instalación en caja universal de mecanismos de 65x65. Ecrã tátil RGBW PWM para regular 1 zona para fitas LED e produto de tensão constante 12-24V, 4 canais de 5A. Permite guardar 4 cores. Necessário fonte de alimentação. Instalação numa caixa universal de derivação de 65x65.

71-7664-00-00



Pantalla táctil DMX básica no programable. Controla simultaneamente luminarias DMX "Broadcast". Permite guardar 4 colores. Instalación en caja universal de mecanismos de 65x65. 100-240V. Ecrã tátil DMX básico, não programável. Controla simultaneamente luminárias DMX "Broadcast". Permite guardar 4 cores. Instalação numa caixa universal de derivação de 65x65. 100-240V.

71-7666-00-00

## Controladores con mando a distancia por radiofrecuencia

Controladores com comando à distância por radiofrequência



Mando a distancia para receptor 71-7668-00-00, 1 canal, 6 escenas, 6 zonas. Comando à distância para recetor 71-7668-00-00, 1 canal, 6 cenas, 6 zonas.

71-7670-00-00



Receptor radiofrecuencia para tiras led y producto a tensión constante 12-48Vdc. 1 canal de 8A. Puede actuar como Master o Esclavo. Máxima distancia de sincronización de 30metros. 6 zonas. Requiere fuente de alimentación. 24Vdc. Recetor de radiofrequência para fitas LED e produto de tensão constante 12-48Vdc. 1 canal de 8A. Pode atuar como Master ou Escravo. Distância máxima de sincronização de 30 metros. 6 zonas. Necessário fonte de alimentação. 24Vdc.

71-7668-00-00



Mando a distancia para receptor 71-7669-00-00, 4 canales RGBW, 6 zonas. Comando à distância para recetor 71-7669-00-00, 4 canais RGBW, 6 zonas.





71-7667-00-00





Receptor radiofrecuencia para tiras led y producto a tensión constante 12-48Vdc. 4 canales de 5A. Puede actuar como Master o Esclavo. Máxima distancia de sincronización de 30metros. 6 zonas. Requiere fuente de alimentación. 24Vdc. Recetor de radiofrequência para tiras LED e produto de tensão constante 12-48Vdc. 4 canais de 5A. Pode atuar como Master ou Escravo. Distância máxima de sincronização de 30 metros. 6 zonas. Necessário fonte de alimentação. 24Vdc.

71-7669-00-00



**Pantallas táctiles DALI para instalación en caja universal de mecanismos****Ecrãs táteis DALI para instalação numa caixa universal de derivação**

	<p>Convertor de señales libre de potencial, apto para incorporar pulsadores convencionales al entorno DALI2. Permite controlar hasta 64 equipos DALI-2 en modo broadcast. Alimentación a 230V</p> <p>Convertor de sinais sem potencial, adequado para incorporar botões convencionais no ambiente DALI2. Permite controlar até 64 equipamentos DALI-2 em modo broadcast. Alimentação a 230V</p>	<b>71-C276-00-00</b>
	<p>Dimmer DALI, 1 zona para máximo 50 drivers. Controla simultáneamente luminarias DALI "Broadcast". Instalacion en caja universal de mecanismos de 65×65. 100-240V</p> <p>Dimmer DALI, 1 zona para o máximo de 50 drivers. Controla simultaneamente as luminárias DALI "Broadcast". Instalação numa caixa universal de derivação de 65×65. 100-240V</p>	<b>71-7671-00-00</b>
	<p>Dimmer DALI, 4 zonas para máximo 50 drivers. Instalación en caja universal de mecanismos de 65×65. Requiere direccionamiento de grupos DALI y por tanto conocimientos de programación DALI. Alimentación DALI.</p> <p>Dimmer DALI, 4 zonas para o máximo de 50 drivers. Instalação numa caixa universal de derivação de 65×65. Requer o direccionamento de grupos DALI e, por conseguinte, conhecimentos de programação DALI. Alimentação DALI.</p>	<b>71-7665-00-00</b>
	<p>Dimmer DALI2 DT8 para productos con blanco dinámico. Máximo 25 drivers. Controla simultáneamente "broadcast" luminarias DALI DT8. Instalación en caja universal de mecanismos de 65×65. 230V.</p> <p>Dimmer DALI2 DT8 para produtos com branco dinâmico. Máximo de 25 drivers. Controla simultaneamente "broadcast" luminárias DALI DT8. Instalação numa caixa universal de derivação de 65×65. 230V</p>	<b>71-B361-00-00</b>

**Controladores PWM 12-24V****Controlador PWM 12-24V**

	<p>Controlador 1-10V PWM para tiras LED y producto a tensión constante 12-24V, 2 canales de 6,5A. Requiere fuente de alimentación.</p> <p>Controlador 1-10V para fitas LED e produto de tensão constante de 12-24V, 2 canais, 6,5A. Necessário fonte de alimentação.</p>	<b>71-0727-00-00</b>
	<p>Controlador DMX-RDM PWM para tiras LED y producto a tensión constante 12-24V, 5 canales de 8A. Requiere fuente de alimentación. Puertos RJ45, XLR y de tornillo. Dispone de modo esclavo DMX o de modo master para funcionamiento autónomo.</p> <p>Controlador DMX-RDM PWM para fitas LED e produtos com tensão constante 12-24V, 5 canais de 8A. Necessário fonte de alimentação. Portas RJ45, XLR e de parafuso. Possui modo escravo DMX ou modo master para funcionamento autónomo.</p>	<b>71-B755-00-00</b>

**Sensores****Sensores**

	<p>Sensor On off con salida rele de hasta 6A. Diámetro de detección de movimiento 6,8m a 3m altura de instalación. 95-250V</p> <p>Sensor on-off com saída de relé até 6A. Diâmetro de deteção de movimento de 6,8 m e 3 m de altura. 95-250V</p>	<b>71-B368-00-00</b>
	<p>Sensor DALI hasta 16 luminarias, para funcionamiento autónomo, control de las luminarias simultáneamente "broadcast". Diámetro de detección de movimiento de 6m a 3m de altura. De 5-a 1000lx de luminosidad. 95-250V</p> <p>Sensor DALI até 16 luminárias, para funcionamento autónomo, controlo das luminárias simultaneamente "broadcast". Diâmetro de deteção de movimento de 6 m e 3 m de altura. De 5 a 1000lx de luminosidade. 95-250V</p>	<b>71-8067-00-00</b>
	<p>Sensor D4i hasta 4 luminarias DALI, para funcionamiento autónomo, integrable en luminaria. Diámetro de detección de movimiento 6m a 3m de altura. De 5 a 1000lx de luminosidad. Alimentación DALI-D4i necesaria.</p> <p>Sensor D4i até 4 luminárias DALI, para funcionamento autónomo, integrável na luminária. Diâmetro de deteção de movimento de 6 m a 3 m de altura. De 5 a 1000lx de luminosidade. Necessária alimentação DALI-D4i.</p>	<b>71-A723-00-00</b>

# Extra Reader's Guide

## Recomendaciones de instalación

### Recomendações de instalação

#### Productos con driver remoto

Se recomienda instalar el driver a un máximo de 2 metros del producto cuando no sea posible verificar los niveles de EMC de cada aplicación, según lo establecido en las normas de referencia. Es necesario verificar la polaridad de los cables del producto antes de conectarlos al secundario del driver, ya que un mal conexionado puede dañar el módulo LED y/o el driver.

#### Regulación

Los cables de señal de regulación deben instalarse separados de los cables de potencia. No está permitido poner interruptores en el secundario del driver.

#### Regulación por línea (corte de fase)

- Regulación básica por línea, no requiere cables adicionales.
- Productos con driver de regulación tipo "L": admiten regulación con dimmers tipo TRIAC/IGBT; regulación por inicio de fase (leading edge/forward phase control).
- Productos con driver de regulación tipo "C": admiten regulación con dimmers tipo IGBT; regulación por final de fase (trailing edge/reverse phase control).
- Productos con driver tipo "LC" admiten los dos tipos de dimmers especificados anteriormente.
- Se recomienda verificar la compatibilidad dimmer-driver.

#### Regulación Push

Requiere un cable adicional. Deben utilizarse pulsadores NA (normalmente abiertos). Una pulsación rápida enciende o apaga el producto. Si se mantiene accionado el pulsador se ajusta el nivel de brillo.

#### Regulación 0/1-10V

Regulación analógica que requiere dos cables adicionales con polaridad. Un dimmer genera una señal a tensión constante entre 0 y 10V. Si se aplica una tensión de 1V el driver ajustará el brillo del producto al mínimo, sin embargo cuando se aplique una tensión de 10V el producto brillará al máximo. Los drivers que admiten una señal de regulación con rango entre 0-10V son capaces de apagar el producto por completo al recibir 0V del dimmer.

#### Control DALI/DALI-2

Protocolo de control digital desarrollado por los principales fabricantes de drivers para crear un estándar de regulación en el sector de la iluminación. Permite memorizar escenas, enviar mensajes en caso de fallo o final de vida del producto, control y planificación punto a punto del producto y gestión de emergencias. Requiere dos cables adicionales sin polaridad. Se recomienda utilizar cable de sección 1.5mm<sup>2</sup>. La certificación DALI-2 mejora la interoperabilidad entre dispositivos DALI.

#### Control DMX

Protocolo de control digital utilizado en el mundo de la iluminación espectacular. Requiere dos cables adicionales con polaridad. Se recomienda el uso de cable trenzado, apantallado y con impedancia 120Ω.

#### Control Casambi

Sistema de control Bluetooth Mesh

Se recomienda no superar los 15m de distancia entre dispositivos, ni utilizar envolventes metálicas que afecten a su comunicación inalámbrica.

#### Produtos com driver remoto

Recomenda-se instalar o driver no máximo a 2 metros do produto quando não for possível verificar os níveis de EMC de cada aplicação, conforme o estabelecido nas normas de referência. É necessário verificar a polaridade dos cabos do produto antes de os conectar ao secundário do driver, já que uma má conexão pode danificar o módulo LED e/ou o driver.

#### Regulação

Os cabos de sinal de regulação devem ser instalados separados dos cabos de potência. Não é permitido colocar interruptores no secundário do driver.

#### Regulação por linha (corte de fase)

- Regulação básica por linha, não requer cabos adicionais.
- Produtos com driver de regulação tipo "L": admitem regulação com dimmers tipo TRIAC/IGBT; regulação por início de fase (leading edge/forward phase control).
- Produtos com driver de regulação tipo "C": admitem regulação com dimmers tipo IGBT; regulação por final de fase (trailing edge/reverse phase control).
- Produtos com driver tipo "LC" admitem os dois tipos de dimmers especificados anteriormente.
- Recomenda-se verificar a compatibilidade dimmer-driver.

#### Regulação Push

Requer um cabo adicional. Devem ser utilizados botões NA (normalmente abertos). Uma pressão rápida liga ou desliga o produto. Mantendo-se o botão pressionado ajusta-se o nível de brilho.

#### Regulação 0/1-10V

Regulação analógica que requer dois cabos adicionais com polaridade. Um dimmer gera um sinal de tensão constante entre 0 e 10V. Se for aplicada uma tensão de 1V, o driver ajustará o brilho do produto no mínimo, contudo quando for aplicada uma tensão de 10V o produto brilhará no máximo. Os drivers que admitem sinal de regulação com um intervalo entre 0-10V são capazes de desligar completamente o produto ao receber 0V do dimmer.

#### Controlo DALI/DALI-2

Protocolo de controlo digital desenvolvido pelos principais fabricantes de drivers para criar um standard de regulação no setor da iluminação. Permite a memorização de cenários, enviar mensagens em caso de falha ou fim de vida do produto, controlo e planificação ponto a ponto do produto e gestão de emergências. Requer dois cabos adicionais sem polaridade. Recomenda-se utilizar um cabo de secção de 1,5 mm<sup>2</sup>. A certificação DALI-2 melhora a interoperabilidade entre os dispositivos DALI.

#### Controlo DMX

Protocolo de controlo digital utilizado no mundo da iluminação espectacular. Requer dois cabos adicionais com polaridade. Recomenda-se o uso de cabo trançado, blindado e com impedância de 120Ω.

#### Controlo Casambi

Sistema de controlo Bluetooth Mesh

Recomenda-se não ultrapassar os 15 m de distância entre dispositivos, nem utilizar envolventes metálicas que afetem a sua comunicação sem fios.

## Información técnica

### Informação técnica

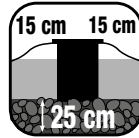

#### EMPOTRABLES DE TIERRA – DRENAJE

Es imprescindible seguir las instrucciones de montaje y la guía de instalación de los empotrables para lograr el mejor funcionamiento posible de la luminaria.

1. Evitar colocar las luminarias en zonas de depresión del terreno.
2. Evitar colocar las luminarias en zonas donde se pueda acumular agua y en ubicaciones permanentemente húmedas, como jardines o césped.
3. Evitar el uso de productos químicos utilizados para el abono de jardines ya que pueden deteriorar algunos componentes.
4. Nivelar la luminaria con el pavimento.
5. Prever un recubrimiento de dilatación en el caso de empotrables colocados en superficies como el cemento o el hormigón para evitar la posible dilatación o compresión.
6. Colocar un drenaje eficaz para evitar el estancamiento de agua, como mínimo de 25 centímetros de grava por debajo de la carcasa de instalación. Un drenaje correcto debe absorber hasta 10 litros de agua en 15 minutos.
7. Hacer funcionar la luminaria durante 20 minutos sin el cristal para evitar condensaciones de agua dentro.

#### ENCASTRÁVEIS NO SOLO – DRENAGEM

É imprescindível que siga as instruções de montagem e o guia de instalação dos encastráveis para obter o melhor funcionamento possível do aparelho de iluminação.

1. Evite colocar os aparelhos de iluminação em zonas de depressão do terreno.
2. Evite colocar os aparelhos de iluminação em zonas onde se possa acumular água e em localizações permanentemente húmidas, como jardins ou relva.
3. Evite o uso de produtos químicos utilizados para o adubamento de jardins, dado que eles podem deteriorar alguns componentes.
4. Nivele o aparelho de iluminação pelo pavimento.
5. Preveja um revestimento de dilatação no caso de encastráveis colocados em superfícies como o cimento ou o betão para evitar a eventual dilatação ou compressão.
6. Coloque uma drenagem eficaz para evitar a estagnação da água, no mínimo de 25 centímetros de gravilha abaixo da carcaça de instalação. Uma drenagem correcta deve absorver até 10 litros de água em 15 minutos.
7. Faça funcionar o aparelho de iluminação durante 20 minutos sem o vidro para evitar condensações de água dentro dele.

---

**Controladores / Controladores**

---

Controlador PWM 12-24V para tiras LED / Controlador PWM 12-24V para fitas LED	71-7664-00-00
---	---------------

---

**RF controladores remotos / RF Controladores remotos**

---

Receptor RGB / Recetor RGB	71-7669-00-00
Mando RGB / Comando RGB	71-7667-00-00
Receptor blanco / Recetor branco	71-7670-00-00
Mando blanco / Comando branco	71-7668-00-00

---

**Reguladores DALI Básicos / Reguladores DALI Básicos**

---

Regulador DALI 1CH / Regulador DALI 1CH	71-7671-00-00
Regulador DALI DT8 2CH TW / Regulador DALI DT8 2CH TW	71-B361-00-00
Regulador DALI 4 zonas / Regulador DALI 4 zonas	71-7665-00-00

---

**Dispositivos DMX / Dispositivos DMX**

---

Controlador DMX / Controlador DMX	71-B755-00-00
Regulador DMX básico / Regulador DMX básico	71-7666-00-00
Consola DMX esencial con pantalla táctil / Consola DMX essencial com ecrã tátil	71-B115-00-00
Consola DMX performance con pantalla táctil / Consola DMX performance com ecrã tátil	71-B116-00-00
Consola DMX advance / Consola DMX advance	71-B667-00-00
Divisor / amplificador 4 outputs / Divisor / amplificador 4 outputs	71-B125-00-00
Divisor / amplificador 10 outputs / Divisor / amplificador 10 outputs	71-B668-00-00
Fuente de alimentación D51mm 12V 12W / Fonte de alimentação D51mm 12V 12W	71-B416-00-00

---

## Drivers



L x W x H mm	IP	CLASS	V in	V out	Constant current Iout (mA)	Potencia máxima (W) Potência máxima (W)	Protocol	
47,5×27,2×20	20	□	220-240V	2,7-4,5V	700	3	ON-OFF	<b>71-B781-00-00</b>
76×22×20	20	□	220-240V	2,5-4,5V	700	3	ON-OFF	<b>71-B682-00-00</b>
300×47×47	67	□	100-240V	2-4V	1200	4,8	ON-OFF	<b>71-E225-05-05</b>
66,3×38,5×21,8	20	□	100-240V	8,6-18V	350	6	ON-OFF	<b>71-A652-00-00</b>
123×45×19	20	□	100-240V	5-13V	700	9	ON-OFF	<b>71-B232-00-00</b>
165×45×37	68	□	100-240V	6-14,5V	700	10	ON-OFF	<b>71-E014-00-00</b>
300×47×47	67	□	100-240V	6-14,5V	700	10	ON-OFF	<b>71-E226-05-05</b>
158×22×19	20	□	90-264V	2-27V	500	14	ON-OFF	<b>71-B406-00-00</b>
115×34×19	20	□	90-264V	1-41,5V	60-360	15	ON-OFF	<b>71-E218-00-00</b>
158×22×19	20	□	100-240V	2-40V	350	15	ON-OFF	<b>71-7699-00-00</b>
123×45×19	20	□	100-240V	23-46V	350	16,1	ON-OFF	<b>71-6652-00-00</b>
121,5×53,5×26	68	□	99-264V	2-49V	350	17	ON-OFF	<b>71-E079-00-00</b>
130×38×28	20	□	110-240V	2-14V	1400	18	ON-OFF	<b>71-E217-00-00</b>
165×45×37	67	□	100-240V	15-29V	700	20	ON-OFF	<b>71-E015-00-00</b>
115×29×45	20	□	100-240V	10-29V	700	20,3	ON-OFF	<b>71-6658-00-00</b>
111×52×22	20	□	100-240V	16-42V	500	21	ON-OFF	<b>71-C111-00-00</b>
105×68×32	20	□	100-240V	21-43V	700	30,1	ON-OFF	<b>71-6653-00-00</b>
105×68×32	20	□	100-240V	21-42V	1050	44,1	ON-OFF	<b>71-6661-00-00</b>
124×79×22	20	□	110-240V	0-74V	350-1050	50	ON-OFF	<b>71-3542-00-00</b>
129×76×30	20	□	99-264V	48V	1050-2100	55	ON-OFF	<b>71-4914-00-00</b>
101,5×49×29	20	□	220-240V	27-42V	350	14	PHASE-CUT 230V	<b>71-A297-00-00</b>
111×52×22	20	□	220-240V	25-51V	350	18	PHASE-CUT 230V	<b>71-C337-00-00</b>
102×38×21	20	□	220-240V	6-14V	700	10	PHASE-CUT 230V	<b>71-7663-00-00</b>
111×52×22	20	□	220-240V	16-42V	500	20	PHASE-CUT 230V	<b>71-C338-00-00</b>
145×51×29,5	20	□	220-240V	17-39V	700	25	PHASE-CUT 230V	<b>71-A299-00-00</b>
166×47×35	20	□	220-240V	2-47V	350-750	32	PHASE-CUT 230V-PUSH	<b>71-4898-00-00</b>
150×43×25	20	□	100-240V	5-13V	700	9	DALI2; PUSH	<b>71-A190-00-00</b>
150×43×25	20	□	100-240V	23-46V	350	16	DALI2; PUSH	<b>71-A191-00-00</b>
135×80×31	68	□	99-264V	10-50V	350	17,5	0-10V; 1-10V; DALI2	<b>71-E083-00-00</b>
97,3×41×22	20	□	110-277V	8-40V	150-500	20	DALI2	<b>71-B407-00-00</b>
152×46×36	20	□	100-240V	10-43V	350-700	30	DALI2; PUSH	<b>71-A192-00-00</b>
135×80×31	68	□	99-264V	10-50V	500	25	DALI2	<b>71-E085-00-00</b>
121,5×53,5×26	68	□	99-264V	2-49V	700	30	DALI2	<b>71-E080-00-00</b>
146×44×30	20	□	220-240V	10-54V	300-1050	38	DALI2; PUSH	<b>71-A303-00-00</b>
124×79×22	20	□	110-240V	2-74V	350-1050	60	PUSH; 0-10V; 1-10V; DALI2	<b>71-4706-00-00</b>
135×80×31	68	□	99-264V	10-50V	1200mA	60	0-10V; 1-10V; DALI2	<b>71-E518-00-00</b>
135×80×31	68	□	99-264V	10-50V	700mA	70	0-10V; 1-10V; DALI2	<b>71-E086-00-00</b>



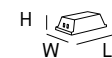



























## Equipos de control / Equipamentos de controlo



□ IP20 □

L x W x H mm	IP	CLASS	V in	Frecuencia Frequência	Potencia máxima (W) Potência máxima (W)	Protocol	
40,4×36,3×14	20	□	220-240V 12-24V	50-60Hz	Max.150W (230V)	CASAMBI-RLC	<b>71-5959-00-00</b>
56,5×35,8×22,3	20	□	24-48V 220-240V	50-60Hz	Max. 1 driver	CASAMBI- DALI/O-10V	<b>71-5961-00-00</b>
30×72,6×18	66	⊕	100-240V 100-240V		Max.144W	CASAMBI-PWM	<b>71-8050-00-00</b>
143×18×59	20	⊕	100-240V 47-63Hz		Max. 64 devices	CASAMBI-DALI	<b>71-8115-00-00</b>
108×108×62	67	□	90-305V 47-63Hz	50-60Hz	Max. 64 devices	CASAMBI-DALI	<b>71-A237-00-00</b>
108×108×62	67	□	90-305V 47-63Hz	50-60Hz	Max. 32 devices	CASAMBI-DMX	<b>71-A238-00-00</b>
91×45×124	67	◇	90-305V 47-63Hz	50-60Hz	Max. 64 devices	CASAMBI	<b>71-A243-14-14</b>
91×45×124	67	◇	90-305V 47-63Hz	50-60Hz	Max. 64 devices	CASAMBI	<b>71-A243-60-60</b>



L x W x H mm	IP	CLASS	V in	Constant voltage Vdc (V)	Potencia máxima (W) Potência máxima (W)	Protocol	
51×49×27	20		220-240V	12	12	ON-OFF	<b>71-B416-00-00</b>
188×50×33,5	67		90-305V	12	96	ON-OFF	<b>71-B676-00-00</b>
146×55×19	20		100-240V	12	20	ON-OFF	<b>71-B677-00-00</b>
146×55×19	20		100-240V	24	20	ON-OFF	<b>71-B650-00-00</b>
300×30×16	20		220-240V	24	30	ON-OFF	<b>71-B640-00-00</b>
350×30×18	20		220-240V	24	100	ON-OFF	<b>71-B641-00-00</b>
350×30×18	20		220-240V	24	150	ON-OFF	<b>71-B642-00-00</b>
400×40×22	20		220-240V	24	250	ON-OFF	<b>71-B643-00-00</b>
205×42×10	67		100-240V	24	20	ON-OFF	<b>71-E101-05-05</b>
250×30×21	67		220-240V	24	30	ON-OFF	<b>71-B644-00-00</b>
290×30×21	67		220-240V	24	60	ON-OFF	<b>71-B645-00-00</b>
320×30×21	67		220-240V	24	100	ON-OFF	<b>71-B646-00-00</b>
350×30×21	67		220-240V	24	160	ON-OFF	<b>71-B647-00-00</b>
400×30×21	67		220-240V	24	240	ON-OFF	<b>71-B648-00-00</b>
400×60×22	67		220-240V	24	400	ON-OFF	<b>71-B649-00-00</b>
300×30×16	20		220-240V	24	60	DALI2	<b>71-B652-00-00</b>
350×30×16	20		220-240V	24	150	DALI2	<b>71-B653-00-00</b>
290×30×21	67		220-240V	24	60	DALI2	<b>71-B655-00-00</b>
350×30×21	67		220-240V	24	160	DALI2	<b>71-B656-00-00</b>
191×63×38	67		90-305V	24	120	CASAMBI;PWM	<b>71-A242-00-00</b>
180×52×30	20		220-240V	48	75	ON-OFF	<b>71-A258-00-00</b>
300×40×30	20		220-240V	48	120	ON-OFF	<b>71-A259-00-00</b>
350×30×18	20		220-240V	48	150	ON-OFF	<b>71-B658-00-00</b>
350×30×18	20		220-240V	48	250	ON-OFF	<b>71-B659-00-00</b>
320×30×21	67		220-240V	48	100	ON-OFF	<b>71-B660-00-00</b>
350×30×21	67		220-240V	48	160	ON-OFF	<b>71-B661-00-00</b>
400×30×21	67		220-240V	48	240	ON-OFF	<b>71-B662-00-00</b>
252×90×44	67		90-305V	48	320	ON-OFF	<b>71-B077-00-00</b>
297×16×19	20		220-240V	48	100	ON-OFF	<b>71-B440-60-00</b>
268×43×22	20		220-240V	48	250	ON-OFF	<b>71-B441-60-00</b>

# Key to Symbols

440

**Acabados**  
Acabamentos































441







**Materiales**  
Materiais

442

**Simbología**  
Simbologia

## Acabados / Acabamentos





















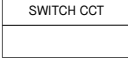

	00	Blanco	Branco
	01	Oro	Ouro
	05	Negro	Preto
	06	Cobre	Cobre
	08	Verde	Verde
	12	Fumé	Fumado
	14	Blanco	Branco
	15	Ámbar	Ámbar
	21	Cromo	Cromado
	23	Oro	Ouro
	27	Latonado	Latão
	34	Gris	Cinzento
	37	Transparente	Transparente
	60	Negro	Preto
	81	Níquel satinado	Níquel acetinado
	92	Fresno oscuro	Cinza escura
	93	Fresno claro	Cinzento claro
	BW	Blanco	Branco
	BY	Arena	Areia
	B8	Cristal satinado	Vidro acetinado
	CI	Marrón	Castanho
	CS	Gris cemento	Cinzento cimento
	DL	Oro	Ouro
	DN	Oro mate	Ouro mate
	DO	Latón pulido	Latão polido
	EF	Oro	Ouro
	EK	Gris oscuro	Cinza escuro
	EM	Gris piedra	Cinzento pedra
	EQ	Marrón claro	Castanho claro
	ES	Rattan natural	Rattan natural
	ET	Oro pintado	Ouro pintado
	EU	Blanco brillante	Branco brilhante
	EV	Negro brillante	Preto brilhante

	EX	Gris oliva	Cinzeno oliva
	F1	Cristal arenado	Vidro fosco
	F5	Oro	Ouro
	F9	Arenado	Areado
	FF	Arena	Areia
	GA	Fieltro gris claro	Feltro cinzeno claro
	GB	Fieltro gris oscuro	Feltro cinzeno escuro
	G5	Cristal pintado blanco interior	Vidro pintado branco interior
	W1	Marrón Caoba	Castanho Caoba
	L1	Terracota jaspeado	Terracota jaspeado
	K3	Cristal espejo	Vidro espelho
	M1	Blanco opal	Branco opalino
	M3	Anodizado	Anodizado























## Materiales / Materiais

<b>ABS</b>	ABS	ABS
<b>ACR</b>	Acrílico	Acrílico
<b>AISI202</b>	Acero inoxidable AISI 202	Aço inoxidável AISI 202
<b>AISI304</b>	Acero inoxidable AISI 304	Aço inoxidável AISI 304
<b>AISI316</b>	Acero inoxidable AISI 316	Aço inoxidável AISI 316
<b>AL</b>	Aluminio	Alumínio
<b>ALAB</b>	Alabastro	Alabastro
<b>BR</b>	Latón	Latão
<b>CON</b>	Cemento	Cimento
<b>FELT</b>	Fieltro	Feltro
<b>G</b>	Grafeno	Grafeno
<b>GL</b>	Fibra de vidrio	Fibra de vidro
<b>GLA</b>	Cristal	Vidro
<b>PC</b>	Polycarbonato	Polycarbonato
<b>PC+ABS</b>	Polycarbonato + ABS	Polycarbonato + ABS
<b>PLABS</b>	Plástico	Plástico
<b>PLSTER</b>	Yeso	Gesso
<b>PMMA</b>	PMMA	PMMA
<b>POLI</b>	Tecnopolímero	Tecnopolímero
<b>PP</b>	Polipropileno	Polipropileno
<b>PUR</b>	Poliuretano	Poliuretano
<b>PVC</b>	PVC	PVC
<b>R</b>	Resina	Resina
<b>RATAN</b>	Ratan	Rattan
<b>ST</b>	Acero	Aço
<b>TEX</b>	Textil	Têxtil
<b>WASHI</b>	Papel japonés	Papel japonês
<b>WOOD</b>	Madera	Madeira
<b>WOODT</b>	Madera de teca	Madeira de teca





















## Simbología / Simbologia

	Sistema de codificación para indicar el grado de protección proporcionado por un envoltente contra la entrada de elementos sólidos y líquidos	Sistema de codificação para a indicação do grau de proteção proporcionado por um envoltente contra a entrada de objetos sólidos e líquidos
	Material de la estructura	Material da estrutura
	Sistema de codificación para indicar el grado de protección proporcionado por un envoltente contra los impactos mecánicos nocivos. Energía de impacto (Jules)	Sistema de codificação para a indicação do grau de proteção proporcionado por um envoltente contra os impactos mecânicos nocivos. Energia de impacto (joules)
	Material del difusor	Material do difusor
	UGR	UGR
	Low Flicker	Low Flicker
	Clase I	Classe I
	Clase II	Classe II
	Clase III	Classe III
	Horas de vida	Horas de vida
	Cumple con la eficacia luminosa exigida para obtener el certificado de construcción sostenible BREEAM, calculada dividiendo los lúmenes reales por la potencia total de la luminaria.	Cumpr e a eficácia luminosa exigida para obter o certificado de construção sustentável BREEAM, calculada pela divisão dos lúmenes reais pela potência total da luminária.
	MacAdam	MacAdam
	WELL. Contribuye al cumplimiento de la característica L06 según el WELL Building Standard®.	WELL. Contribui para o cumprimento da característica L06 de acordo com o WELL Building Standard®.
	Switch CCT	Switch CCT
	RGB Light	RGB Light
	Luminarias no adecuadas para cubrirse con material aislante térmico	Luminárias não adequadas para serem cobertas com material isolante térmico
	Luminarias no adecuadas para el montaje directo en superficies normalmente inflamables	Luminárias não adequadas para a montagem direta em superfícies normalmente inflamáveis
	ATENCIÓN - Esta luminaria puede soportar una carga estática limitada. ES APTA para zonas donde eventualmente circulan vehículos a baja velocidad. NO ES APTA para zonas de paso habitual de vehículos	ATENÇÃO - Esta luminária pode suportar uma carga estática limitada. É ADEQUADA para zonas onde, eventualmente, circulam veículos a baixa velocidade. NÃO É ADEQUADA para zonas de passagem habitual de veículos
	Nº de metros máximos. de conexión en serie	Nº de metros máximo de ligação em série
	x metros de cable	x metros de cabo
	Doble salida de cable	Dupla saída de cabos
	Precableado (20cm) con 4 conectores rápidos estancos (hembra + hembra a la izquierda y macho + macho a la derecha).	Pré-cablagem (20cm) com 4 conectores rápidos estanques (fêmea + fêmea à esquerda e macho + macho à direita).
	Precableado (20cm) y con 2 conectores rápidos estancos incluidos (hembra a la izquierda y macho a la derecha).	Pré-cablagem (20cm) com 2 conectores rápidos estanques (fêmea à esquerda e macho à direita).
	Precableado (20cm) con 2 conectores rápidos estancos (macho a la izquierda y macho a la derecha).	Pré-cablagem (20cm) com 2 conectores rápidos estanques (macho à esquerda e macho à direita).

## Simbología / Simbologia

	Precableado (20cm) con 1 conector rápido estanco (macho).	Pré-cablagem (20cm) com 1 conetor rápido estanque (macho).
	Precableado (20cm) con 1 conector rápido estanco (macho). Incluye 1 prensaestopas extra.	Pré-cablado (20cm) com 1 conetor rápido estanque (macho). Inclui 1 bucim extra pré-cablado.
	Precableado (20cm) con 4 conectores rápidos estancos (todos hembra).	Pré-cablagem (20cm) com 4 conectores rápidos estanques (todos fêmea).
	Luminaria adecuada para instalar en ambientes con atmósfera marina. La garantía no cubre el cambio de color o el deterioro de la pintura causado por la luz solar y/o el ambiente salino, a no ser que afecte la seguridad mecánica y estructural del producto. En ambientes marinos se debe hacer un mantenimiento cada 6 meses como máximo para eliminar eventuales depósitos de sal.	Luminária adequada para instalar em ambientes com atmosfera marinha. A garantia não cobre a mudança de cor ou a deterioração da pintura causada pela luz solar e/ou ambiente salino, a menos que afete a segurança mecânica e estrutural do produto. Em ambientes marinhos, deve-se fazer uma manutenção a cada 6 meses, no máximo, para eliminar eventuais depósitos de sal.
	Sistema de regulación DIMABLE.	Sistema de regulação DIMMÁVEL
	Sistema de regulación NO DIMABLE.	Sistema de regulação NO DIMMÁVEL.
	Drenaje. Ver las recomendaciones de instalación en la pág. 432.	Drenagem. Ver as recomendações de instalação na pág. 432.
	Incluye sistema de fijación al suelo desarrollada por LedsC4 que garantiza la robustez y durabilidad de las luminarias y que entre ellas no haya diferencias de inclinación aunque el suelo sea irregular.	Inclui um sistema de fixação ao solo desenvolvido pela LedsC4 que garante a robustez e durabilidade das luminárias e que entre elas não existam diferenças de inclinação, mesmo que o solo seja irregular.
	Orientable	Orientável
	Orientable	Orientável
	Orientable	Orientável
	Orientable	Orientável
	Orientable	Orientável
	Orientable	Orientável
	Orientable	Orientável
	Orientable	Orientável
	Interruptor de encendido	Interruptor de ligar/desligar
	Doble interruptor de encendido	Duplo interruptor de ligar/desligar
	Interruptor táctil	Interruptor tátil
	Interruptor de encendido en el cable	Interruptor de ligar/desligar no fio
	Espejo de aumento x5	Espelho de aumento x5
	Espejo de aumento x3	Espelho de aumento x3
	Mando a distancia	Comando à distância

## Simbología / Simbologia

 xm	Nº de metros máximos. de conexión en serie	Nº de metros máximo de ligação em série
 ANTI FOG	Antifog. Sistema incluido para evitar que el espejo se empañe con el vapor de agua.	Antineblina. Sistema incluido para evitar que o espelho embacice com o vapor de água.
 SAFETY BACK	La lámina de seguridad es una película aplicada en el reverso de los espejos para evitar las lesiones causadas en caso de rotura del cristal.	A lâmina de segurança é uma película aplicada na parte posterior dos espelhos para evitar lesões provocadas em caso de quebra do vidro.
	Luminaria apta para el paso de vehículos según normativa EN 60598-2-13 (ensayos de resistencia a la torsión y carga cortante).	Luminária adequada à passagem de veículos segundo a norma EN 60598-2-13 (ensaios de resistência à torção e força cortante).
AIRFLOW	Airflow (CFM). Unidad de medida del caudal de aire del ventilador (pies cúbicos por minuto).	Airflow (CFM). Unidade de medida do caudal de ar do ventilador (pés cúbicos por minuto).
DC MOTOR	DC Motors. Motor de corriente continua. Mejor eficiencia y consumo.	DC Motors. Motor de corrente contínua. Melhor eficiência e consumo.
	Incorpora fuente de luz	Incorpora fonte de luz
BLADES MAT	Material de las palas	Material das lâminas
	La función inversa hace girar las palas en sentido contrario. Durante los meses de frío, permite desplazar el aire caliente desde el techo hasta el suelo y calentar la estancia ahorrando energía usándolo con el sistema de calefacción.	A função inversa faz rodar as lâminas em sentido contrário. Durante os meses frios, permite deslocar o ar quente do teto para o chão e aquecer a divisão poupando energia utilizando-o com o sistema de aquecimento.
 x2	Velocidad de ventilación, velocidad de giro del motor.	Velocidade de ventilação, velocidade de rotação do motor.
 USB	Conexión USB	Ligação USB
 USB C	Conexión USB-C	Ligação USB-C
	Corte a medida	Corte à medida
	Fuente de luz no reemplazable	Fonte de luz não substituível
	Fuente de luz reemplazable por un técnico cualificado	Fonte de luz substituível por um técnico qualificado
	Fuente de luz reemplazable por el usuario final	Fonte de luz substituível pelo usuário final
	Driver no reemplazable	Driver não substituível
	Driver reemplazable por un técnico cualificado	Driver substituível por um técnico qualificado
	Driver reemplazable por el usuario final	Driver substituível pelo usuário final
	Wireless	Wireless
	Sensor	Sensor
	Luminarias con conectividad integrada.	Luminárias com conectividade integrada.
	Equipo no incluido	Equipamento não incluído
	Equipo incluido	Equipamento incluído

## Simbología / Simbologia

STANDBY LIGHTING	Luminaria con kit de autonomía integrado para continuidad de servicio en caso de fallo de red. Ideal para zonas donde se requiera iluminación de apoyo no sujeta a requisitos de evacuación normativa.	Luminária com kit de autonomia integrado para continuidade de serviço em caso de falha de rede. Ideal para zonas onde seja necessária iluminação de apoio não sujeita a requisitos normativos de evacuação.
UNE-EN 60598-2-22	Cumple con los requisitos generales que se aplican a las luminarias de emergencia.	Cumpre os requisitos gerais aplicáveis às luminárias de emergência.
	Los anclajes permiten su instalación en techos de X mm a X mm	As fixações permitem a sua instalação em tetos de X mm a X mm
	Consultar disponibilidad	Consultar Disponibilidade
	Diámetro de empotramiento	Diâmetro de encastramento
	Corte de empotramiento	Corte de encastramento
	El driver sí pasa por el agujero de empotrar	O driver passa pelo orifício de encastrar
	El driver no pasa por el agujero de empotrar	O driver não passa pelo orifício de encastrar
	Variación de la temperatura de color de blanco cálido a frío	Variação da temperatura de cor de branco quente a frio
	Quick Service 2-6 días laborables (tiempo de transporte no incluido)	Quick Service 2-6 dias úteis (tempo de transporte não incluído)

## Índice por referencias / Índice por referências

Referencia Referência	Pág. Pág.	Referencia Referência	Pág. Pág.	Referencia Referência	Pág. Pág.	Referencia Referência	Pág. Pág.
00-0001-XX-XX	166	00-7398-XX-XX	135	00-8385-XX-XX	139	00-A056-XX-XX	72
00-0002-XX-XX	166	00-7399-XX-XX	135	00-8389-XX-XX	139	00-A057-XX-XX	73
00-0641-XX-XX	166	00-7400-XX-XX	134	00-8392-XX-XX	125	00-A058-XX-XX	69
00-0642-XX-XX	166	00-7401-XX-XX	134	00-8395-XX-XX	125	00-A059-XX-XX	73
00-3642-XX-XX	167	00-7402-XX-XX	135	00-8403-XX-XX	99	00-A060-XX-XX	69
00-3646-XX-XX	167	00-7403-XX-XX	135	00-8405-XX-XX	99	00-A061-XX-XX	70
00-3647-XX-XX	167	00-7404-XX-XX	135	00-8406-XX-XX	99	00-A062-XX-XX	70
00-3648-XX-XX	167	00-7405-XX-XX	135	00-8513-XX-XX	155	00-A063-XX-XX	73
00-3649-XX-XX	167	00-7589-XX-XX	121	00-8514-XX-XX	155	00-A064-XX-XX	71
00-4925-XX-XX	176	00-7591-XX-XX	121	00-8527-XX-XX	147	00-A065-XX-XX	71
00-4926-XX-XX	176	00-7685-XX-XX	85	00-8528-XX-XX	147	00-A066-XX-XX	71
00-5456-XX-XX	171	00-7686-XX-XX	85	00-8533-XX-XX	149	00-A067-XX-XX	71
00-5693-XX-XX	153	00-7687-XX-XX	85	00-8534-XX-XX	149	00-A068-XX-XX	71
00-5694-XX-XX	153	00-7688-XX-XX	85	00-8535-XX-XX	150	00-A069-XX-XX	71
00-5695-XX-XX	153	00-7689-XX-XX	85	00-8536-XX-XX	150	00-A070-XX-XX	71
00-5696-XX-XX	153	00-7690-XX-XX	85	00-8537-XX-XX	148	00-A071-XX-XX	71
00-6010-XX-XX	94	00-7691-XX-XX	84	00-8646-XX-XX	158	00-A072-XX-XX	70
00-6011-XX-XX	94	00-7692-XX-XX	84	00-8648-XX-XX	158	00-A073-XX-XX	70
00-6012-XX-XX	94	00-7693-XX-XX	84	00-8656-XX-XX	158	00-A074-XX-XX	70
00-6013-XX-XX	94	00-7694-XX-XX	84	00-8658-XX-XX	158	00-A075-XX-XX	70
00-6017-XX-XX	147	00-7695-XX-XX	84	00-8667-XX-XX	158	00-A076-XX-XX	71
00-6018-XX-XX	147	00-7696-XX-XX	84	00-8669-XX-XX	158	00-A077-XX-XX	71
00-6021-XX-XX	148	00-7727-XX-XX	119	00-8902-XX-XX	110	00-A078-XX-XX	71
00-6303-XX-XX	85	00-7728-XX-XX	119	00-8933-XX-XX	110	00-A079-XX-XX	71
00-6304-XX-XX	85	00-7729-XX-XX	119	00-8953-XX-XX	110	00-A080-XX-XX	72
00-6305-XX-XX	85	00-7730-XX-XX	119	00-9003-XX-XX	115	00-A081-XX-XX	72
00-6306-XX-XX	84	00-7731-XX-XX	119	00-9007-XX-XX	133	00-A082-XX-XX	72
00-6307-XX-XX	84	00-7732-XX-XX	119	00-9032-XX-XX	122	00-A083-XX-XX	72
00-6308-XX-XX	84	00-7742-XX-XX	142	00-9033-XX-XX	128	00-A084-XX-XX	72
00-6314-XX-XX	85	00-7899-XX-XX	163	00-9034-XX-XX	128	00-A085-XX-XX	72
00-6315-XX-XX	85	00-7900-XX-XX	163	00-9035-XX-XX	128	00-A086-XX-XX	72
00-6316-XX-XX	85	00-7901-XX-XX	163	00-9036-XX-XX	128	00-A087-XX-XX	72
00-6317-XX-XX	84	00-7984-XX-XX	115	00-9042-XX-XX	133	00-A088-XX-XX	69
00-6318-XX-XX	84	00-7986-XX-XX	115	00-9043-XX-XX	133	00-A089-XX-XX	69
00-6319-XX-XX	84	00-7992-XX-XX	144	00-9044-XX-XX	134	00-A090-XX-XX	69
00-6452-XX-XX	94	00-7993-XX-XX	144	00-9045-XX-XX	134	00-A091-XX-XX	69
00-6454-XX-XX	94	00-8107-XX-XX	103	00-9046-XX-XX	134	00-A092-XX-XX	69
00-6455-XX-XX	94	00-8108-XX-XX	103	00-9047-XX-XX	135	00-A093-XX-XX	69
00-6457-XX-XX	94	00-8248-XX-XX	69	00-9048-XX-XX	135	00-A094-XX-XX	69
00-6458-XX-XX	94	00-8261-XX-XX	70	00-9049-XX-XX	135	00-A095-XX-XX	69
00-6460-XX-XX	94	00-8271-XX-XX	70	00-9050-XX-XX	142	00-A096-XX-XX	75
00-6461-XX-XX	94	00-8276-XX-XX	72	00-9052-XX-XX	142	00-A097-XX-XX	75
00-6463-XX-XX	94	00-8280-XX-XX	73	00-9053-XX-XX	142	00-A098-XX-XX	75
00-6666-XX-XX	149	00-8285-XX-XX	73	00-A015-XX-XX	101	00-A099-XX-XX	75
00-6667-XX-XX	149	00-8292-XX-XX	69	00-A016-XX-XX	101	00-A100-XX-XX	75
00-6668-XX-XX	150	00-8296-XX-XX	70	00-A017-XX-XX	173	00-A101-XX-XX	75
00-6669-XX-XX	150	00-8299-XX-XX	70	00-A018-XX-XX	173	00-A102-XX-XX	75
00-6670-XX-XX	161	00-8301-XX-XX	73	00-A019-XX-XX	121	00-A103-XX-XX	75
00-6671-XX-XX	161	00-8302-XX-XX	158	00-A020-XX-XX	121	00-A104-XX-XX	74
00-7382-XX-XX	153	00-8303-XX-XX	158	00-A024-XX-XX	90	00-A105-XX-XX	74
00-7383-XX-XX	153	00-8304-XX-XX	158	00-A025-XX-XX	90	00-A106-XX-XX	74
00-7384-XX-XX	153	00-8305-XX-XX	158	00-A026-XX-XX	90	00-A107-XX-XX	74
00-7385-XX-XX	153	00-8306-XX-XX	158	00-A027-XX-XX	91	00-A108-XX-XX	73
00-7388-XX-XX	133	00-8307-XX-XX	158	00-A028-XX-XX	91	00-A109-XX-XX	73
00-7389-XX-XX	133	00-8317-XX-XX	148	00-A041-XX-XX	91	00-A110-XX-XX	73
00-7390-XX-XX	133	00-8337-XX-XX	164, 369	00-A042-XX-XX	90	00-A111-XX-XX	73
00-7391-XX-XX	133	00-8348-XX-XX	138	00-A043-XX-XX	90	00-A112-XX-XX	74
00-7392-XX-XX	133	00-8364-XX-XX	138	00-A044-XX-XX	90	00-A113-XX-XX	74
00-7393-XX-XX	133	00-8365-XX-XX	138	00-A045-XX-XX	91	00-A114-XX-XX	74
00-7394-XX-XX	134	00-8369-XX-XX	138	00-A046-XX-XX	91	00-A115-XX-XX	74
00-7395-XX-XX	134	00-8373-XX-XX	138	00-A047-XX-XX	91	00-A116-XX-XX	74
00-7396-XX-XX	134	00-8377-XX-XX	139	00-A054-XX-XX	70	00-A117-XX-XX	74
00-7397-XX-XX	134	00-8381-XX-XX	139	00-A055-XX-XX	70	00-A118-XX-XX	74

00-A119-XX-XX	74	00-A197-XX-XX	73	05-6396-XX-XX	367	05-A018-XX-XX	68
00-A126-XX-XX	70	00-A198-XX-XX	73	05-6420-XX-XX	192	05-A019-XX-XX	68
00-A127-XX-XX	70	00-A199-XX-XX	73	05-6421-XX-XX	192	05-A020-XX-XX	67
00-A128-XX-XX	70	00-A200-XX-XX	74	05-6428-XX-XX	193	05-A021-XX-XX	68
00-A129-XX-XX	70	00-A201-XX-XX	74	05-6488-XX-XX	195	05-A022-XX-XX	67
00-A130-XX-XX	72	00-A202-XX-XX	74	05-7366-XX-XX	200	05-A023-XX-XX	67
00-A131-XX-XX	72	00-A203-XX-XX	74	05-7367-XX-XX	200	05-A024-XX-XX	68
00-A132-XX-XX	73	00-A204-XX-XX	74	05-7380-XX-XX	185	05-A025-XX-XX	68
00-A133-XX-XX	73	00-A205-XX-XX	74	05-7381-XX-XX	185	05-A026-XX-XX	291
00-A134-XX-XX	69	00-A206-XX-XX	74	05-7382-XX-XX	185	05-A027-XX-XX	291
00-A135-XX-XX	69	00-A207-XX-XX	74	05-7383-XX-XX	185	05-A028-XX-XX	291
00-A136-XX-XX	73	00-A232-XX-XX	163	05-7385-XX-XX	293	05-A029-XX-XX	67
00-A137-XX-XX	73	00-A294-XX-XX	110	05-7387-XX-XX	311, 349, 370	05-A030-XX-XX	67
00-A138-XX-XX	69	00-A295-XX-XX	110	05-7388-XX-XX	303	05-A031-XX-XX	67
00-A139-XX-XX	69	00-A296-XX-XX	110	05-7389-XX-XX	303	05-A032-XX-XX	68
00-A140-XX-XX	70	00-A337-XX-XX	163	05-7573-XX-XX	315	05-A033-XX-XX	68
00-A141-XX-XX	70	00-A338-XX-XX	111	05-7574-XX-XX	315	05-A034-XX-XX	68
00-A142-XX-XX	70	00-A339-XX-XX	111	05-7574-XX-XX	315	05-A035-XX-XX	67
00-A143-XX-XX	70	00-A340-XX-XX	111	05-7575-XX-XX	315	05-A036-XX-XX	67
00-A144-XX-XX	73	00-A341-XX-XX	111	05-7576-XX-XX	315	05-A037-XX-XX	67
00-A145-XX-XX	73	00-A342-XX-XX	111	05-7582-XX-XX	308	05-A038-XX-XX	67
00-A146-XX-XX	71	00-A343-XX-XX	111	05-7588-XX-XX	298	05-A039-XX-XX	67
00-A147-XX-XX	71	00-A344-XX-XX	111	05-7606-XX-XX	189	05-A040-XX-XX	67
00-A148-XX-XX	71	00-A345-XX-XX	111	05-7742-XX-XX	307	05-A041-XX-XX	68
00-A149-XX-XX	71	00-A346-XX-XX	111	05-7831-XX-XX	365	05-A042-XX-XX	68
00-A150-XX-XX	71	00-A347-XX-XX	111	05-7833-XX-XX	365	05-A043-XX-XX	68
00-A151-XX-XX	71	00-A348-XX-XX	111	05-7982-XX-XX	197	05-A044-XX-XX	68
00-A152-XX-XX	71	00-A349-XX-XX	111	05-8102-XX-XX	291	05-A045-XX-XX	68
00-A153-XX-XX	71	00-A350-XX-XX	109	05-8103-XX-XX	291	05-A076-XX-XX	277, 359
00-A154-XX-XX	70	00-A351-XX-XX	109	05-8104-XX-XX	291	05-A077-XX-XX	277, 359
00-A155-XX-XX	70	00-A352-XX-XX	109	05-8249-XX-XX	67	05-A078-XX-XX	183
00-A156-XX-XX	70	00-A353-XX-XX	109	05-8250-XX-XX	67	05-A088-XX-XX	325
00-A157-XX-XX	70	00-A354-XX-XX	109	05-8255-XX-XX	67	05-A091-XX-XX	316
00-A158-XX-XX	71	00-A355-XX-XX	109	05-8279-XX-XX	68	05-A102-XX-XX	367
00-A159-XX-XX	71	00-A356-XX-XX	109	05-8329-XX-XX	190	05-A103-XX-XX	319
00-A166-XX-XX	71	00-A357-XX-XX	109	05-8335-XX-XX	353	05-A104-XX-XX	319
00-A167-XX-XX	71	00-A358-XX-XX	109	05-8336-XX-XX	353	05-A105-XX-XX	319
00-A168-XX-XX	72	00-A359-XX-XX	109	05-8337-XX-XX	369	05-A109-XX-XX	51
00-A169-XX-XX	72	00-A360-XX-XX	109	05-8339-XX-XX	194	05-A110-XX-XX	51
00-A170-XX-XX	72	00-A361-XX-XX	109	05-8348-XX-XX	305	05-E202-XX-XX	321
00-A171-XX-XX	72	00-A366-XX-XX	110	05-8356-XX-XX	284	05-E203-XX-XX	321
00-A172-XX-XX	72	00-A367-XX-XX	110	05-8357-XX-XX	284	05-E206-XX-XX	322
00-A173-XX-XX	72	00-A368-XX-XX	110	05-8358-XX-XX	287	05-E207-XX-XX	321
00-A174-XX-XX	72	00-A369-XX-XX	110	05-8359-XX-XX	284	05-E209-XX-XX	297
00-A175-XX-XX	72	00-A370-XX-XX	110	05-8360-XX-XX	284	05-E210-XX-XX	297
00-A176-XX-XX	69	00-A371-XX-XX	110	05-8361-XX-XX	285	10-4759-XX-XX	237
00-A177-XX-XX	69	00-A372-XX-XX	51	05-8362-XX-XX	285	10-5693-XX-XX	227
00-A178-XX-XX	69	00-A373-XX-XX	51	05-8363-XX-XX	285	10-6010-XX-XX	219
00-A179-XX-XX	69	00-A374-XX-XX	51	05-8399-XX-XX	313	10-6011-XX-XX	219
00-A180-XX-XX	69	00-A375-XX-XX	51	05-8400-XX-XX	205	10-6420-XX-XX	228
00-A181-XX-XX	69	00-A376-XX-XX	51	05-8401-XX-XX	206	10-7385-XX-XX	227
00-A182-XX-XX	69	00-A377-XX-XX	51	05-8509-XX-XX	187	10-7582-XX-XX	229
00-A183-XX-XX	69	00-A378-XX-XX	51	05-8510-XX-XX	191	10-7742-XX-XX	216
00-A184-XX-XX	75	05-1793-XX-XX	324	05-8513-XX-XX	295	10-7982-XX-XX	230
00-A185-XX-XX	75	05-1794-XX-XX	324	05-8515-XX-XX	312	10-8102-XX-XX	223
00-A186-XX-XX	75	05-2759-XX-XX	196	05-8540-XX-XX	203	10-8327-XX-XX	243
00-A187-XX-XX	75	05-2830-XX-XX	199	05-9007-XX-XX	303	10-8350-XX-XX	237
00-A188-XX-XX	75	05-2831-XX-XX	199	05-9683-XX-XX	323	10-8516-XX-XX	233
00-A189-XX-XX	75	05-4401-XX-XX	317	05-A005-XX-XX	367	10-8518-XX-XX	233
00-A190-XX-XX	75	05-5085-XX-XX	299	05-A011-XX-XX	288, 361	10-8540-XX-XX	235
00-A191-XX-XX	75	05-5296-XX-XX	201	05-A012-XX-XX	363	10-9055-XX-XX	225
00-A192-XX-XX	74	05-5306-XX-XX	310	05-A013-XX-XX	67	10-A001-XX-XX	247
00-A193-XX-XX	74	05-5307-XX-XX	310	05-A014-XX-XX	68	10-A002-XX-XX	215
00-A194-XX-XX	74	05-5478-XX-XX	355	05-A015-XX-XX	67	10-A003-XX-XX	215
00-A195-XX-XX	74	05-5693-XX-XX	293	05-A016-XX-XX	67	10-A004-XX-XX	215
00-A196-XX-XX	73	05-6193-XX-XX	198	05-A017-XX-XX	68	10-A005-XX-XX	215

## Índice por referencias / Índice por referências

10-A009-XX-XX	211	15-A366-XX-XX	338	71-8067-XX-XX	429	71-B662-XX-XX	435
10-A026-XX-XX	223	15-A367-XX-XX	338	71-8115-XX-XX	423, 434	71-B667-XX-XX	427, 433
10-A078-XX-XX	220	15-A368-XX-XX	338	71-8318-XX-XX	147, 148	71-B668-XX-XX	427, 433
15-0073-XX-XX	354	25-4759-XX-XX	271	71-8332-XX-XX	243, 247	71-B669-XX-XX	423
15-4370-XX-XX	371	25-5693-XX-XX	263	71-8497-XX-XX	66	71-B670-XX-XX	424
15-4922-XX-XX	177, 348	25-6420-XX-XX	264	71-8498-XX-XX	66	71-B671-XX-XX	424
15-6196-XX-XX	169, 345	25-7385-XX-XX	263	71-A190-XX-XX	434	71-B672-XX-XX	424
15-6197-XX-XX	169, 345	25-7582-XX-XX	253	71-A191-XX-XX	434	71-B673-XX-XX	424
15-6433-XX-XX	169, 345	25-7742-XX-XX	259	71-A192-XX-XX	434	71-B674-XX-XX	424
15-7723-XX-XX	85	25-8102-XX-XX	261	71-A237-XX-XX	423, 434	71-B676-XX-XX	435
15-7982-XX-XX	353	25-8350-XX-XX	271	71-A238-XX-XX	423, 434	71-B677-XX-XX	435
15-8330-XX-XX	309, 347	25-8394-XX-XX	257	71-A240-XX-XX	424	71-B682-XX-XX	434
15-8331-XX-XX	309, 347	25-8520-XX-XX	267	71-A241-XX-XX	425	71-B743-XX-XX	425
15-8514-XX-XX	352	25-8521-XX-XX	267	71-A242-XX-XX	424, 435	71-B750-XX-XX	425
15-8902-XX-XX	338	25-8522-XX-XX	267	71-A243-XX-XX	423, 434	71-B755-XX-XX	427, 429, 433, 437
15-8933-XX-XX	338	25-8540-XX-XX	269	71-A258-XX-XX	435	71-B756-XX-XX	421
15-8953-XX-XX	338	25-8566-XX-XX	257	71-A259-XX-XX	435	71-B781-XX-XX	434
15-A052-XX-XX	177, 348	25-A001-XX-XX	252	71-A297-XX-XX	434	71-B830-XX-XX	421
15-A125-XX-XX	279, 342	25-A002-XX-XX	252	71-A299-XX-XX	434	71-B831-XX-XX	421
15-A126-XX-XX	279, 342	25-A026-XX-XX	261	71-A300-XX-XX	423	71-B849-XX-XX	419
15-A127-XX-XX	279, 342	25-A076-XX-XX	255	71-A303-XX-XX	434	71-B850-XX-XX	420
15-A128-XX-XX	280, 343	30-5378-XX-XX	406	71-A652-XX-XX	434	71-B853-XX-XX	427
15-A129-XX-XX	280, 343	30-7973-XX-XX	402	71-A696-XX-XX	425	71-B855-XX-XX	423
15-A130-XX-XX	280, 343	30-8548-XX-XX	412	71-A723-XX-XX	429	71-B863-XX-XX	427
15-A131-XX-XX	330	30-A001-XX-XX	394	71-A857-XX-XX	424	71-B864-XX-XX	424
15-A132-XX-XX	330	71-0073-XX-XX	354, 171, 196	71-B077-XX-XX	435	71-B865-XX-XX	424
15-A133-XX-XX	330	71-0727-XX-XX	429	71-B098-XX-XX	420	71-B866-XX-XX	424
15-A134-XX-XX	331	71-3542-XX-XX	434	71-B099-XX-XX	421	71-B876-XX-XX	420
15-A135-XX-XX	331	71-4695-XX-XX	177	71-B100-XX-XX	420	71-B877-XX-XX	420
15-A136-XX-XX	331	71-4706-XX-XX	434	71-B101-XX-XX	420	71-B908-XX-XX	419
15-A137-XX-XX	330	71-4898-XX-XX	434	71-B102-XX-XX	419	71-B909-XX-XX	419
15-A138-XX-XX	330	71-4914-XX-XX	434	71-B103-XX-XX	419		
15-A139-XX-XX	330	71-5166-XX-XX	97	71-B113-XX-XX	424		393, 396,
15-A140-XX-XX	331	71-5167-XX-XX	97	71-B115-XX-XX	426, 433	71-B940-XX-XX	398, 400, 410
15-A141-XX-XX	331	71-5658-XX-XX	97	71-B116-XX-XX	426, 433		
15-A142-XX-XX	331	71-5959-XX-XX	423, 434	71-B117-XX-XX	421	71-C012-XX-XX	419
15-A294-XX-XX	338	71-5961-XX-XX	423, 434	71-B125-XX-XX	427, 433	71-C013-XX-XX	420
15-A295-XX-XX	338	71-6022-XX-XX	147	71-B232-XX-XX	434	71-C014-XX-XX	420
15-A296-XX-XX	338	71-6099-XX-XX	97	71-B361-XX-XX	429, 433	71-C111-XX-XX	434
15-A297-XX-XX	338	71-6196-XX-XX	169	71-B368-XX-XX	429	71-C253-XX-XX	48
15-A298-XX-XX	338	71-6196-XX-XX	169	71-B401-XX-XX	420	71-C254-XX-XX	48
15-A299-XX-XX	338	71-6652-XX-XX	434	71-B406-XX-XX	434	71-C255-XX-XX	48
15-A338-XX-XX	339	71-6653-XX-XX	434	71-B407-XX-XX	434	71-C256-XX-XX	48
15-A339-XX-XX	339	71-6658-XX-XX	434			71-C257-XX-XX	48
15-A340-XX-XX	339	71-6661-XX-XX	434	71-B416-XX-XX	427, 433, 435	71-C258-XX-XX	48
15-A341-XX-XX	339	71-7660-XX-XX	308	71-B440-XX-XX	435	71-C259-XX-XX	48
15-A342-XX-XX	339	71-7663-XX-XX	434	71-B441-XX-XX	435	71-C260-XX-XX	48
15-A343-XX-XX	339	71-7664-XX-XX	428, 433, 437	71-B640-XX-XX	435, 436	71-C261-XX-XX	48
15-A344-XX-XX	339	71-7665-XX-XX	429, 433	71-B641-XX-XX	435, 436	71-C262-XX-XX	48
15-A345-XX-XX	339	71-7665-XX-XX	429, 433	71-B642-XX-XX	435, 436	71-C263-XX-XX	48
15-A346-XX-XX	339	71-7666-XX-XX	426, 428, 433	71-B643-XX-XX	435, 436	71-C264-XX-XX	48
15-A347-XX-XX	339	71-7667-XX-XX	428, 433	71-B644-XX-XX	435, 436	71-C265-XX-XX	48
15-A348-XX-XX	339	71-7668-XX-XX	428, 433, 437	71-B645-XX-XX	435, 436	71-C266-XX-XX	48
15-A349-XX-XX	339	71-7669-XX-XX	428, 433, 437	71-B646-XX-XX	435, 436	71-C268-XX-XX	427
15-A350-XX-XX	337	71-7670-XX-XX	428, 433	71-B647-XX-XX	435, 436	71-C269-XX-XX	427
15-A351-XX-XX	337	71-7671-XX-XX	429, 433	71-B648-XX-XX	435, 436	71-C270-XX-XX	427
15-A352-XX-XX	337	71-7699-XX-XX	434	71-B649-XX-XX	435, 436	71-C271-XX-XX	427
15-A353-XX-XX	337	71-7895-XX-XX	97	71-B650-XX-XX	435, 436	71-C272-XX-XX	427
15-A354-XX-XX	337	71-8049-XX-XX	425	71-B652-XX-XX	435, 437	71-C274-XX-XX	423
15-A355-XX-XX	337	71-8050-XX-XX	424, 434	71-B653-XX-XX	435, 437	71-C275-XX-XX	423
15-A356-XX-XX	337	71-8051-XX-XX	423	71-B655-XX-XX	435, 437	71-C276-XX-XX	429
15-A357-XX-XX	337	71-8052-XX-XX	425	71-B656-XX-XX	435, 437	71-C277-XX-XX	420, 427
15-A358-XX-XX	337	71-8053-XX-XX	424	71-B658-XX-XX	435	71-C278-XX-XX	420
15-A359-XX-XX	337			71-B659-XX-XX	435	71-C280-XX-XX	427
15-A360-XX-XX	337			71-B660-XX-XX	435	71-C337-XX-XX	434
15-A361-XX-XX	337			71-B661-XX-XX	435	71-C338-XX-XX	434

## Índice por referencias / Índice por referências

71-C340-XX-XX	393, 396, 398, 400, 410	71-E518-XX-XX	434	PAN-177-XX	206, 313, 237	VE-0091-XXX	398
71-C341-XX-XX	393	75-8508-XX-XX	373	PAN-178-XX	206, 313	VE-0092-XXX	396
71-C351-XX-XX	425	AV14-XXXXXXXXXX	97	PAN-179-XX	206, 313, 237	VE-0093-XXX	410
71-C352-XX-XX	425	AV15-XXXXXXXXXX	97	PAN-232-XX	203	VE-0094-XXX	400
71-E014-XX-XX	434	AV16-XXXXXXXXXX	97	PAN-234-XX	269	VE-0095-XXX	388
71-E015-XX-XX	434	AV26-XXXXXXXXXX	97	QSXX-00XXAZXXXX	40	VE-0096-XXX	386
71-E079-XX-XX	434	CDXX-00XXAZXXXX	34	RSXX-00XXAZXXXX	40	VE-0097-XXX	389
71-E080-XX-XX	434	CFXX-00XXAZXXXX	34	SCXX-XXX-XXXXXX- XXX	54	VE-0098-XXX	387
71-E083-XX-XX	434	CFXX-05XXAZXXXX	36	SQXX-XXX-XXXXXX- XXX	54	VE-0112-XXX	388
71-E085-XX-XX	434	CPXX-05XXAZXXXX	36	SV-D0101	427	VE-0113-XXX	389
71-E086-XX-XX	434	CSXX-00XXAZXXXX	34	SV-D0102	427	VE-0114-XXX	386
71-E098-XX-XX	420	CSXX-05XXAZXXXX	36	TSXX-00XXAZXXXX	40	VE-0115-XXX	387
71-E099-XX-XX	420	LSXX-00XXAZXXXX	40	VE-0016-XXX	404	VE-0118-XXX	390
71-E101-XX-XX	435	OSXX-00XXAZXXXX	40	VE-0020-XXX	408	VE-0119-XXX	391
71-E217-XX-XX	434	PAN-157-XX	206, 313, 237	VE-0022-XXX	404	VE-0120-XXX	390
71-E218-XX-XX	434	PAN-161-XX	237	VE-0023-XXX	404	VE-0121-XXX	391
71-E225-XX-XX	434	PAN-175-XX	206, 313	VE-0090-XXX	402		
71-E226-XX-XX	434	PAN-176-XX	206, 313, 237				
71-E300-XX-XX	424						

## Información importante

## Informação importante

Debido a la constante evolución de la tecnología LED, los datos técnicos de los productos pueden variar en el tiempo. Recomendamos consultar la ficha técnica en la página web ([ledsc4.com](http://ledsc4.com)) para disponer de versión actualizada.

Devido à constante evolução da tecnologia LED, os dados técnicos dos produtos podem variar no tempo. Recomendamos que consulte a ficha técnica na página web ([ledsc4.com](http://ledsc4.com)) para dispor de versão atualizada.

Todos los derechos reservados. Ninguna parte de este libro puede ser reproducida en ningún formato de papel o electrónico, sin el consentimiento previo del editor o de los propietarios de los derechos.

Todos os direitos reservados. Nenhuma parte deste livro pode ser reproduzida em nenhum formato de papel ou eletrônico, sem o consentimento prévio do editor ou dos titulares dos direitos.

Copyright © LedsC4 2026  
All rights reserved

---

# LedsC4

Afores s/n 25750 Torà  
Lleida – Spain  
+34 973 468 100  
ledsc4@ledsc4.com

---

## Customer Service

### Spain

+34 973 468 101  
spain@ledsc4.com

### Europe

+34 973 468 102  
europe@ledsc4.com

### Latin America

+34 973 468 115  
sudamerica@ledsc4.com

### LedsC4 Centro Innovación Madrid

Pol. Industrial Ventorro del Cano  
Calle Cercedilla 11 Nave1  
28925 Alcorcón, Madrid

### Colombia

+601 3441723

### Poland

Leds Polska Sp. z o.o.  
Ul. Kasztanowa 44  
05-816Michalowice-Wies POLAND  
+48 71 733 64 01  
biuro@ledsc4.pl

### United Kingdom

Free phone: 0808 234 2641  
uk@ledsc4.com

### Italy

Toll-free: 800 784 275  
italia@ledsc4.com

### Asia Pacific

+34 973 468 116  
asiapacific@ledsc4.com

### Canada

Toll-free: +1-866-5636666  
CustomerServiceUS@ledsc4.com

### Germany

ImWissenschaftspark  
Deutschland GmbH  
Munscheidstraße 14  
45886 Gelsenkirchen GERMANY  
+49 209 882 99 021  
deutschland@ledsc4.com

### Asia Pacific

8 Robinson Road  
#03-00 ASO Building  
048544 SINGAPORE  
+34 973468116

### France

+33 448 800 142  
france@ledsc4.com

### Portugal

+34 973 468 102  
portugal@ledsc4.com

### Benelux

+34 973 468 102  
benelux@ledsc4.com

### Africa

+34 973 468 116  
africa@ledsc4.com

### United States

Toll-free: +1-888-3710243  
CustomerServiceUS@ledsc4.com

### Middle East

Fortune Executive Tower  
Cluster T - Office 204  
Jumeirah Lake Towers  
PO 336910 Dubai - UAE  
+971 4458 4272

### South Africa

LedsC4 PTY LTD  
8 Neserton drive  
Isandovale  
Edenwale  
Johannesburg 1609  
+34 973 468 115  
southafrica@ledsc4.com

---

## Press







comunicacion@ledsc4.com

## Suppliers

+ 34 973 468 113

---

new website  
**LedsC4.com**

-  Instagram: [instagram.com/leds\\_c4/](https://www.instagram.com/leds_c4/)
-  Facebook: [facebook.com/ledsc4.sa](https://www.facebook.com/ledsc4.sa)
-  LinkedIn: [linkedin.com/company/ledsc4](https://www.linkedin.com/company/ledsc4)
-  YouTube: [youtube.com/ledsC4](https://www.youtube.com/ledsC4)
-  Pinterest: [pinterest.com/ledsc4](https://www.pinterest.com/ledsc4)
-  X: [x.com/ledsc4](https://x.com/ledsc4)





**Este catálogo incluye todas las familias de luminarias y ventiladores para uso decorativo. Es el resultado de más de 50 años de experiencia ofreciendo luz de calidad, confortable y eficiente, para todo tipo de proyectos que buscan el mejor equilibrio entre diseño, tecnología, innovación, servicio y sostenibilidad.**

Este catálogo inclui todas as famílias de luminárias e ventiladores para uso decorativo. É o resultado de mais de 50 anos de experiência oferecendo iluminação de qualidade, confortável e eficiente, para todo tipo de projetos que procuram o melhor equilíbrio entre design, tecnologia, inovação, serviço e sustentabilidade.

Light for better living

Ledsc4.com